

Data Sheet

MH-Series MH4 Plus Analog

Magnetostrictive Linear Position Sensors

- Stroke length up to 2500 mm
- Linearity < 0.04 % F.S. / Resolution typ. 0.1 mm
- High reliability due to EMC, shock & vibration resistance

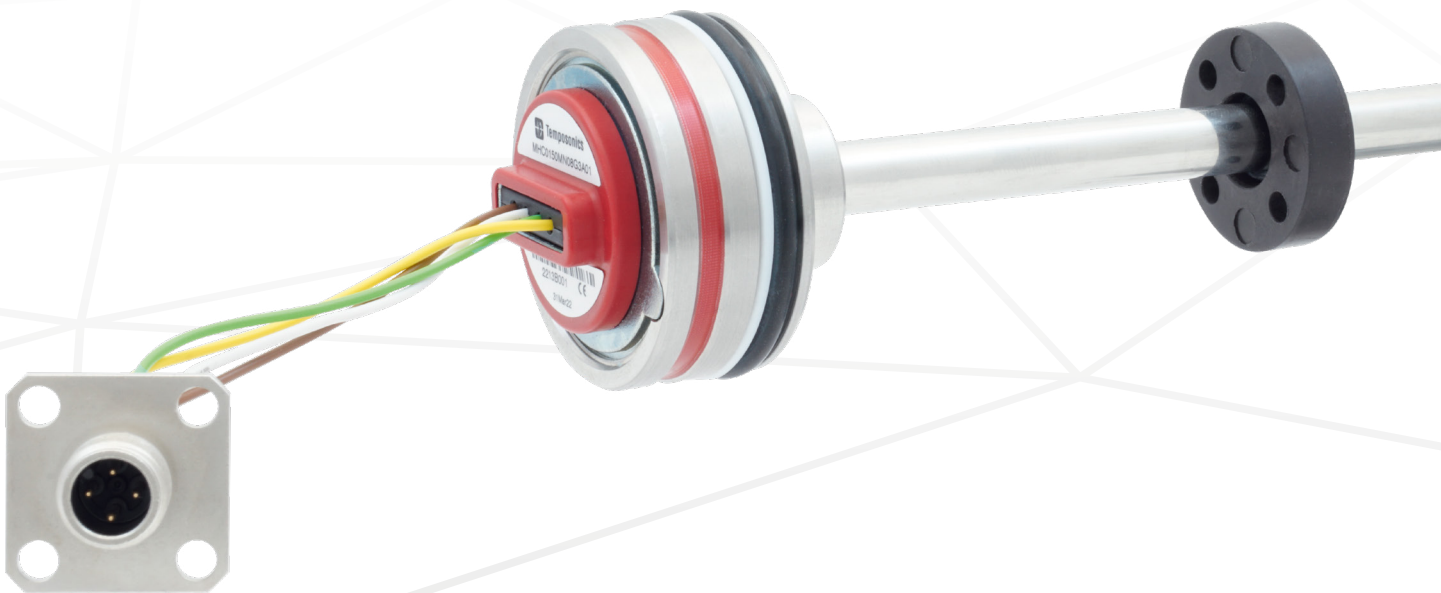

MEASURING TECHNOLOGY

The absolute, linear position sensors provided by Temposonics rely on the company's proprietary magnetostrictive technology, which can determine position with a high level of precision and robustness. Each Temposonics® position sensor consists of a ferromagnetic waveguide, a position magnet, a strain pulse converter and a supporting electronics. The magnet, connected to the object in motion in the application, generates a magnetic field at its location on the waveguide. A short current pulse is applied to the waveguide. This creates a momentary radial magnetic field and torsional strain on the waveguide. The momentary interaction of the magnetic fields releases a torsional strain pulse that propagates the length of the waveguide. When the ultrasonic wave reaches the beginning of the waveguide it is converted into an electrical signal. Since the speed of the ultrasonic wave in the waveguide is precisely known, the time required to receive the return signal can be converted into a linear position measurement with both high accuracy and repeatability.

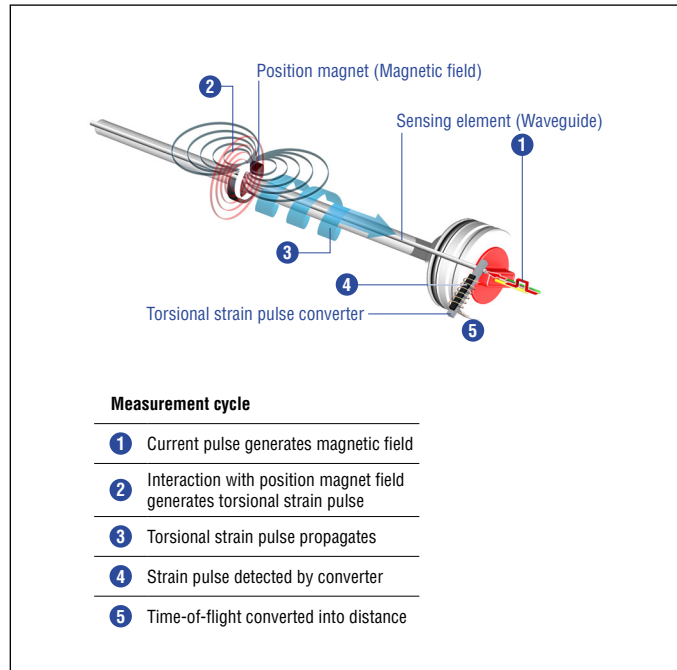

Fig. 1: Time-of-flight based magnetostrictive position sensing principle

MH SENSOR

Temposonics® sensors can be used in versatile mobile machines without any restriction and replace contact-based linear sensors like potentiometers. Highly dynamic systems are controlled safely by means of Temposonics® sensors, thus enhancing the productivity, availability and quality of the working process of the machine. Insensitive to vibration, shock, dust and weathering influence and electro-magnetic disturbances. Temposonics® MH sensors are successfully used in front axle and articulated frame steering cylinders, hydraulic jacks and in steering systems for hydraulic units on agricultural and construction machinery.

DESIGNED FOR THE MOBILE WORLD

MH sensors are designed for mobile machines and intended for IN cylinder use. They are validated in the field by worldwide OEM's and replace linear potentiometers and inductive sensors.



Fig. 2: Typical applications

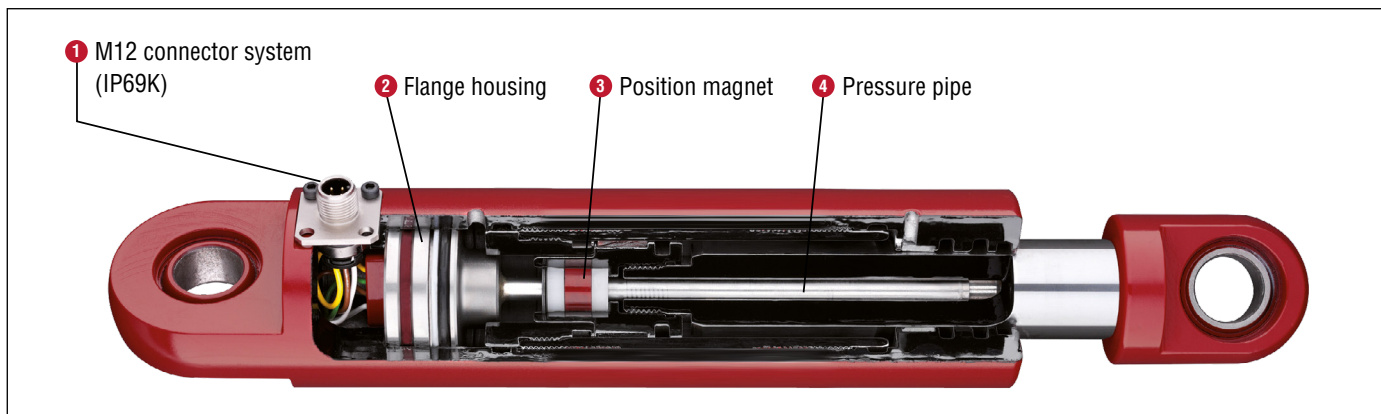

Fig. 3: IN cylinder installation

TECHNICAL DATA

Output	
Voltage	0.25...4.75 VDC / 0.5...4.5 VDC / 0.5...9.5 VDC / 4.75...0.25 VDC / 4.5...0.5 VDC
Current	4...20 mA / 20...4 mA
Measured value	Position
Measurement parameters	
Stroke length	50...2500 mm
Resolution	Better than 0.1 mm
Power up time	250 ms (typical)
Linearity	0050...0250 mm $\leq \pm 0.1$ mm 0255...2000 mm ± 0.04 % (F.S.) 2005...2500 mm $\leq \pm 0.8$ mm
Internal sample rate	2 ms
Setpoint tolerance	≤ 1 mm
Repeatability	± 0.1 mm
Operating conditions	
Operating temperature electronics	-40...+105 °C
Humidity	90 % relative humidity, no condensation, EN60068-2-30
Ingress protection - Connector	M12 connector: IP67/IP69K (connectors correctly fitted), EN60529 DT connector system: IP67/IP69K (connectors correctly fitted), EN60529
Ingress protection – Sensor housing	IP67, EN60529
Shock	100 g (11 ms) single shock per axis, IEC 60068-2-27 50 g (11 ms) at 1000 shocks per axis, IEC 60068-2-29
Vibration	Operational sine vibration test IEC 60068-2-6: Ø 7 mm sensor rod: 15 g (5...2000 Hz)* Ø 10 mm sensor rod: 20 g (5...2000 Hz)* Survival random vibration test IEC 60068-2-64: 20 g RMS (20...2000 Hz) 12 h per axis*
EMC	Compliant with: ISO 13766-1:2018 Earth-moving and building construction machinery EN ISO 14982:2009 Agricultural and Forestry Machinery EN 13309:2010 Construction machinery ISO 16750-2:2012 Road vehicles
EMI	200 V/m (ISO 11452-2:2019 200...2000 MHz) 200 mA (ISO 11452-4:2011 20...200 MHz)
Operating pressure ratings	
	Pressure (according to DIN EN ISO 19879)**
PN (nominal operating)	Ø 7 mm sensor rod: 300 bar Ø 10 mm sensor rod: 350 bar
Pmax (max. overload)	Ø 7 mm sensor rod: 400 bar Ø 10 mm sensor rod: 450 bar
Pstatic (proof pressure)	Ø 7 mm sensor rod: 525 bar Ø 10 mm sensor rod: 625 bar
Design / Material	
Sensor electronics housing	Stainless steel 1.4305 (AISI 303)
Sealing	O-ring: HNBR 70, back-up ring: PTFE
Sensor rod	Ø 7 mm sensor rod: Stainless steel 1.4301 (AISI 304) Ø 10 mm sensor rod: Stainless steel 1.4306 (AISI 304L)

* / Resonance frequencies excluded

** / According to calculations under use of the FKM guideline

Cycles	Ø 7 mm sensor rod	Ø 10 mm sensor rod
Dynamic pressure: $< 2 \times 10^6$ pressure cycles	300 bar	350 bar
Static pressure: $< 2 \times 10^4$ pressure cycles	400 bar	450 bar
Proof pressure: Maximum 5 minutes testing time for cylinder pressure test	525 bar	625 bar

Temposonics® MH-Series MH4 Plus Analog

Data Sheet

Electrical connection	
Connection type	M12 connector or DT connector system or single wires or cable output
Operating voltage	12/24 VDC nominal (8...32 VDC)
Min Load resistance (output VDC)	10 k Ω
Max Load resistance (output mA)	250 Ω (500 Ω if supply > 13 V)
Max Inrush current	4.5 A/2 ms (2.5 A/2 ms if supply < 13 V)
Supply voltage ripple	< 1 % PP
Power drain	< 1 W
Over voltage protection (GND-VDC)	Up to +36 VDC
Polarity protection (GND-VDC)	Up to -36 VDC
Insulation Resistance	R \geq 10 M Ω @ 60 sec
Electric strength	500 VDC (DC GND to chassis GND)

TECHNICAL DRAWING

MH-C – Rod: Ø 10 mm / Dead zone: 63.5 mm / Stroke length: 50...2500 mm

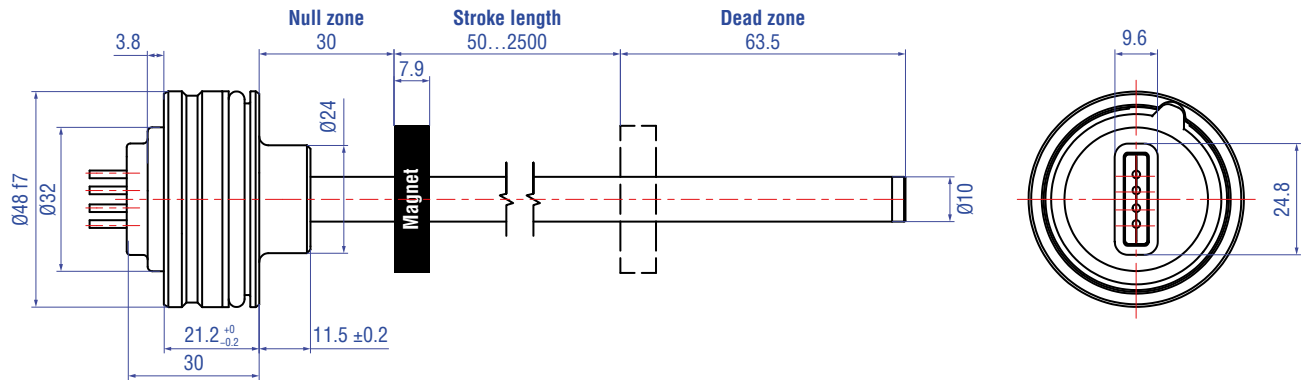

MH-D – Rod: Ø 7 mm / Dead zone: 63.5 mm / Stroke length: 50...2500 mm

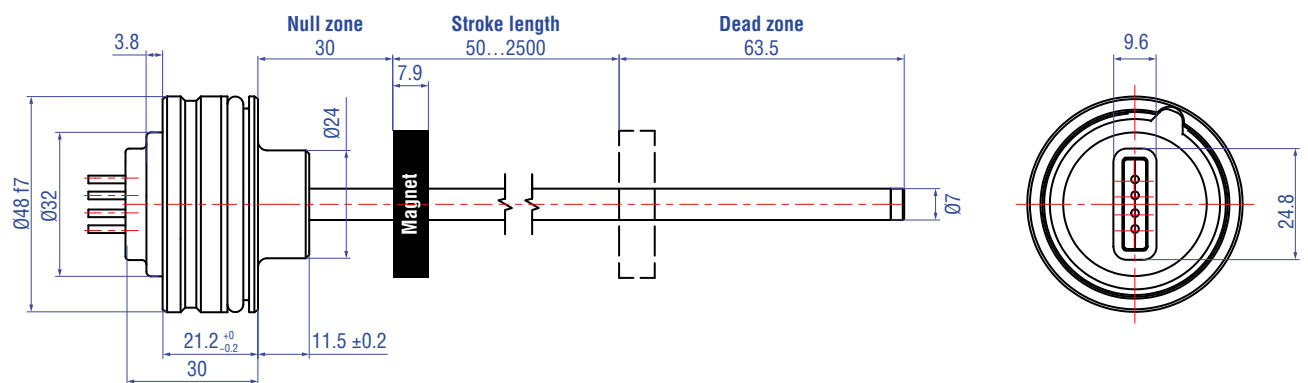

MH-E – Rod: Ø 10 mm / Dead zone: 36.5 mm / Stroke length: 50...1200 mm

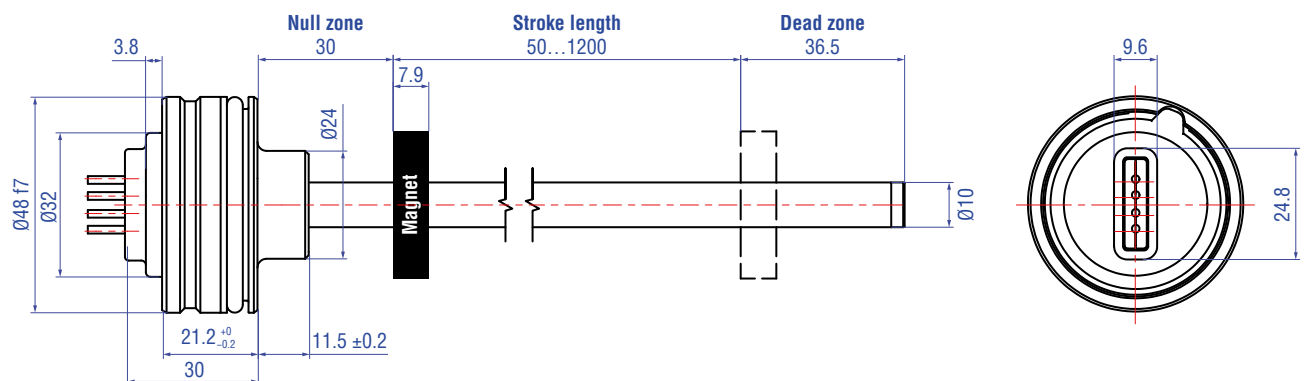

Controlling design dimensions are in millimeters

Fig. 4: Tempsonics® MH-Series MH sensor, part 1

MH-F – Rod: Ø 7 mm / Dead zone: 36.5 mm / Stroke length: 50...1200 mm

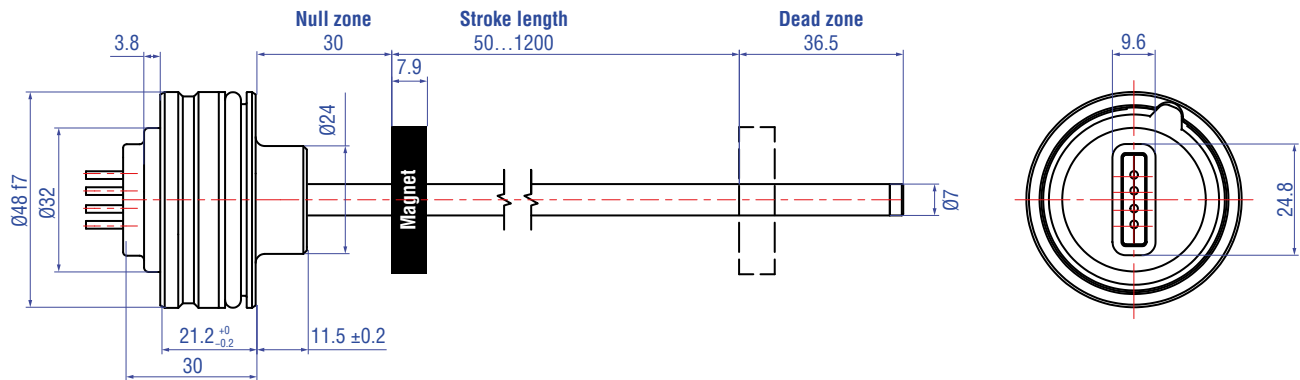

MH-L – Rod: Ø 10 mm + end plug with female M6 thread / Dead zone: 69.5 mm / Stroke length: 50...2500 mm

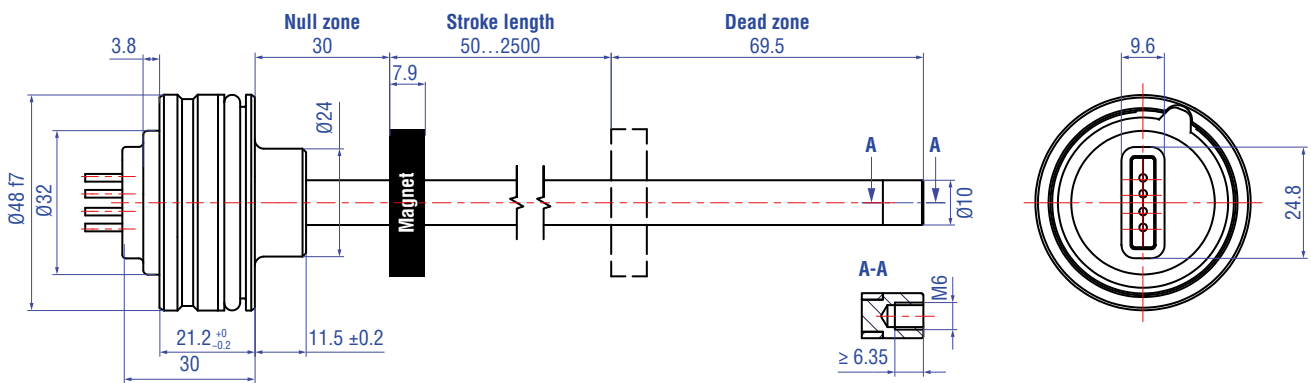

MH-R – Rod: Ø 10 mm + end plug with female M4 thread / Dead zone: 69.5 mm / Stroke length: 50...2500 mm

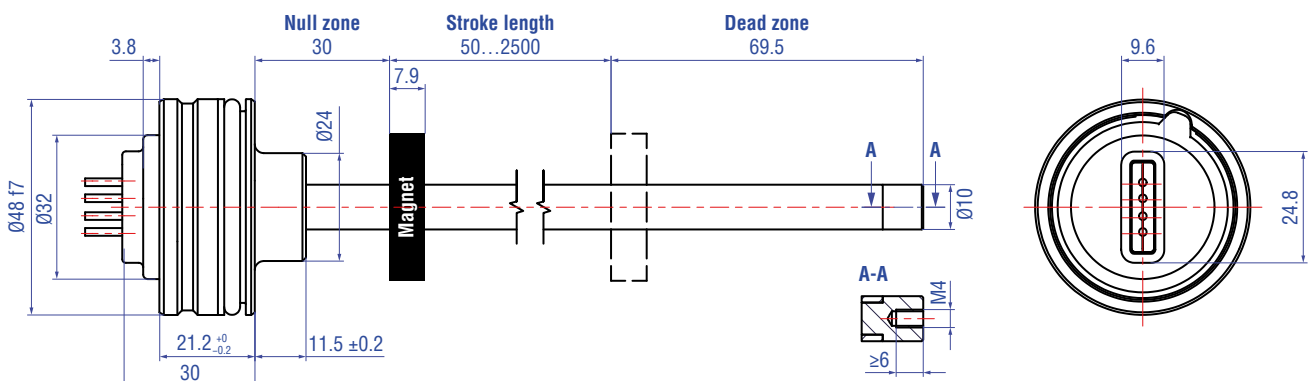

Controlling design dimensions are in millimeters

Fig. 5: Temposonics® MH-Series MH sensor, part 2

MH-C with conical end plug "K1" for Ø 10 mm

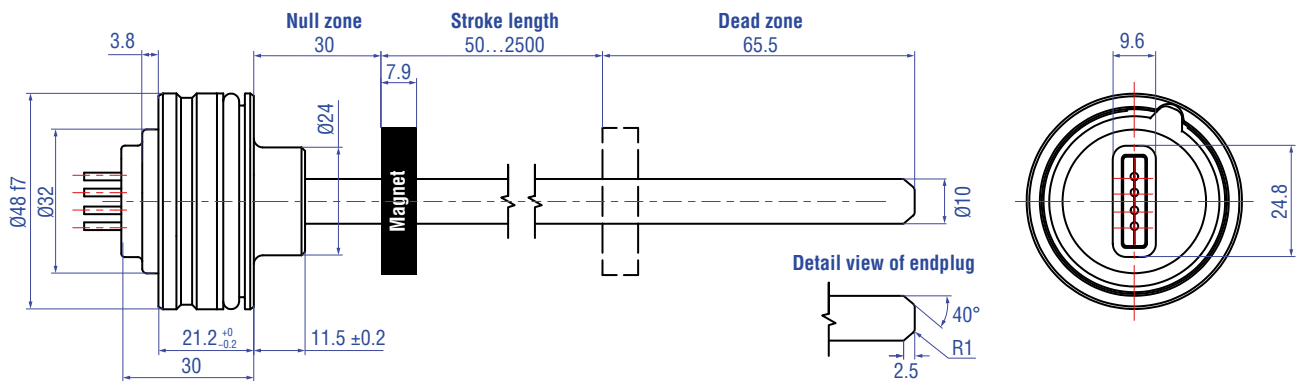

MH-D with conical end plug "K1" for Ø 7 mm

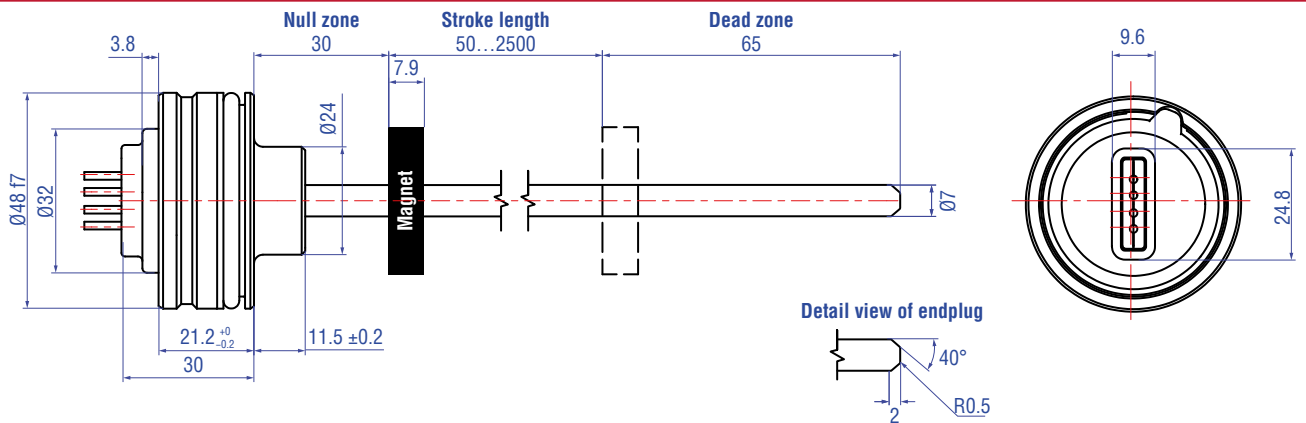

MH-E with conical end plug "K1" for Ø 10 mm

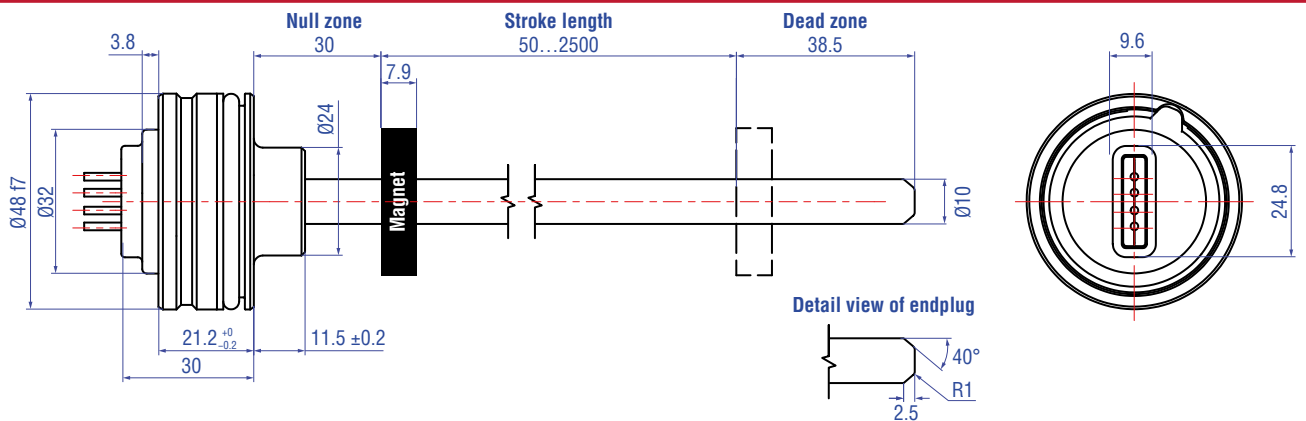

MH-F with conical end plug "K1" for Ø 7 mm

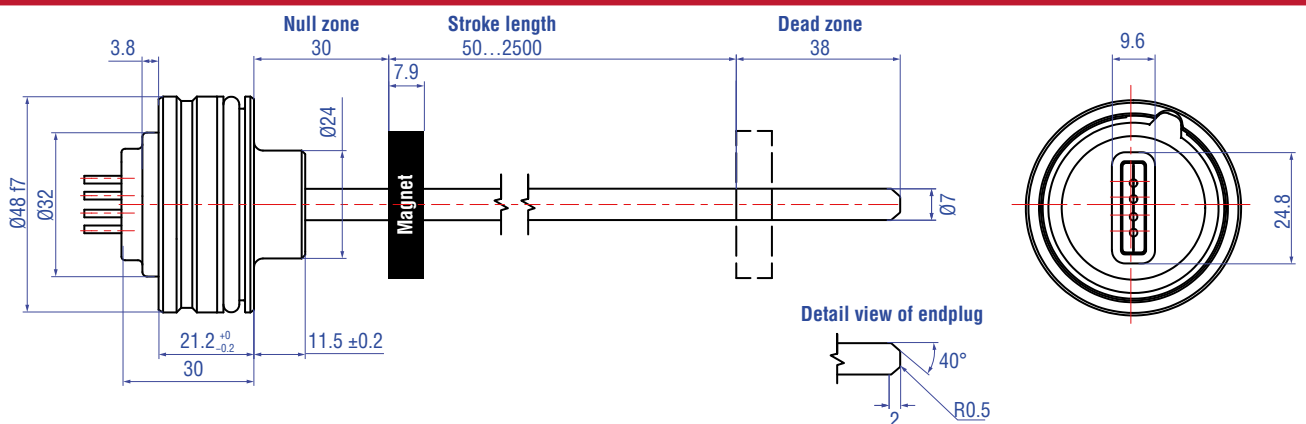

Controlling design dimensions are in millimeters

Fig. 6: Temposonics® MH-Series MH sensor, part 3

CONNECTOR WIRING

M12 connector system (N...E)																		
	<ul style="list-style-type: none"> • Single lead wires 0.22 mm² • Attached A-coded M12 connector attached • Toolless assembly • Sealing IP67, up to IP69K with plugged mating connector 																	
	<table border="1"> <thead> <tr> <th colspan="3">Connector wiring</th> </tr> <tr> <th>Pin</th> <th>Wire</th> <th>Function</th> </tr> </thead> <tbody> <tr> <td>1</td> <td>YE</td> <td>not connected</td> </tr> <tr> <td>2</td> <td>BN</td> <td>VDC</td> </tr> <tr> <td>3</td> <td>WH</td> <td>GND</td> </tr> <tr> <td>4</td> <td>GN</td> <td>SIG</td> </tr> </tbody> </table>	Connector wiring			Pin	Wire	Function	1	YE	not connected	2	BN	VDC	3	WH	GND	4	GN
Connector wiring																		
Pin	Wire	Function																
1	YE	not connected																
2	BN	VDC																
3	WH	GND																
4	GN	SIG																
M12 connector system (N...G)																		
	<ul style="list-style-type: none"> • Single lead wires 0.22 mm² • Attached A-coded M12 connector attached • Toolless assembly • Sealing IP67, up to IP69K with plugged mating connector 																	
	<table border="1"> <thead> <tr> <th colspan="3">Connector wiring</th> </tr> <tr> <th>Pin</th> <th>Wire</th> <th>Function</th> </tr> </thead> <tbody> <tr> <td>1</td> <td>BN</td> <td>VDC</td> </tr> <tr> <td>2</td> <td>YE</td> <td>not connected</td> </tr> <tr> <td>3</td> <td>WH</td> <td>GND</td> </tr> <tr> <td>4</td> <td>GN</td> <td>SIG</td> </tr> </tbody> </table>	Connector wiring			Pin	Wire	Function	1	BN	VDC	2	YE	not connected	3	WH	GND	4	GN
Connector wiring																		
Pin	Wire	Function																
1	BN	VDC																
2	YE	not connected																
3	WH	GND																
4	GN	SIG																
M12 connector system (N...H)																		
	<ul style="list-style-type: none"> • Single lead wires 0.22 mm² • Attached A-coded M12 connector attached • Toolless assembly • Sealing IP67, up to IP69K with plugged mating connector 																	
	<table border="1"> <thead> <tr> <th colspan="3">Connector wiring</th> </tr> <tr> <th>Pin</th> <th>Wire</th> <th>Function</th> </tr> </thead> <tbody> <tr> <td>1</td> <td>BN</td> <td>VDC</td> </tr> <tr> <td>2</td> <td>GN</td> <td>SIG</td> </tr> <tr> <td>3</td> <td>WH</td> <td>GND</td> </tr> <tr> <td>4</td> <td>YE</td> <td>not connected</td> </tr> </tbody> </table>	Connector wiring			Pin	Wire	Function	1	BN	VDC	2	GN	SIG	3	WH	GND	4	YE
Connector wiring																		
Pin	Wire	Function																
1	BN	VDC																
2	GN	SIG																
3	WH	GND																
4	YE	not connected																
Single wires pigtail (N...A)																		
	<ul style="list-style-type: none"> • Single lead wires 0.5 mm² • Insulation PVC 																	
	<table border="1"> <thead> <tr> <th colspan="2">Connector wiring</th> </tr> <tr> <th>Color</th> <th>Function</th> </tr> </thead> <tbody> <tr> <td>BN</td> <td>VDC</td> </tr> <tr> <td>WH</td> <td>GND</td> </tr> <tr> <td>GN</td> <td>SIG</td> </tr> </tbody> </table>	Connector wiring		Color	Function	BN	VDC	WH	GND	GN	SIG							
Connector wiring																		
Color	Function																	
BN	VDC																	
WH	GND																	
GN	SIG																	

Fig. 7: Connector wiring

Controlling design dimensions are in millimeters





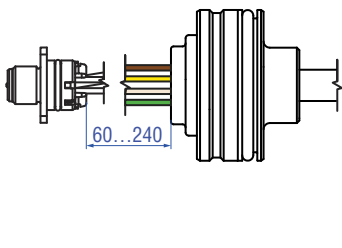
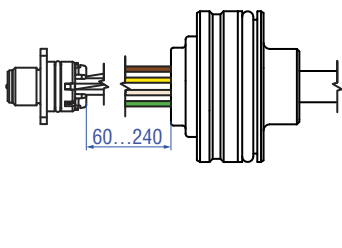
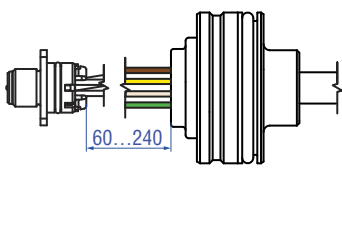
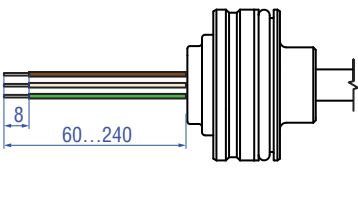



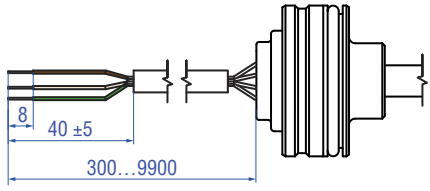

Pigtail cable (T...A)																								
	<ul style="list-style-type: none"> • PUR cable grey • Ø 5 mm, non-shielded, 3 × 0.5 mm² • Flexible, oil resistance <table border="1" style="width: 100%; border-collapse: collapse;"> <thead> <tr> <th colspan="3" style="background-color: #cccccc;">Connector wiring</th> </tr> <tr> <th style="width: 30%;"></th> <th style="width: 30%;">Color</th> <th style="width: 40%;">Function</th> </tr> </thead> <tbody> <tr> <td style="text-align: center;"></td> <td>BN</td> <td>VDC</td> </tr> <tr> <td style="text-align: center;"></td> <td>WH</td> <td>GND</td> </tr> <tr> <td style="text-align: center;"></td> <td>GN</td> <td>SIG</td> </tr> </tbody> </table>	Connector wiring				Color	Function		BN	VDC		WH	GND		GN	SIG								
Connector wiring																								
	Color	Function																						
	BN	VDC																						
	WH	GND																						
	GN	SIG																						
DT connector system E (A...E)																								
	<ul style="list-style-type: none"> • Single lead wires 0.22 mm² • Attached DT compatible connector • Sealing IP69K (with or without mating connector) • Wiring sequence controlled at sensor <table border="1" style="width: 100%; border-collapse: collapse;"> <thead> <tr> <th colspan="3" style="background-color: #cccccc;">Connector wiring</th> </tr> <tr> <th style="width: 20%;"></th> <th style="width: 15%;">Wire</th> <th style="width: 15%;">Pin</th> <th style="width: 50%;">Function</th> </tr> </thead> <tbody> <tr> <td style="text-align: center;"></td> <td>YE</td> <td>1</td> <td>not connected</td> </tr> <tr> <td></td> <td>BN</td> <td>2</td> <td>VDC</td> </tr> <tr> <td></td> <td>WH</td> <td>3</td> <td>GND</td> </tr> <tr> <td></td> <td>GN</td> <td>4</td> <td>SIG</td> </tr> </tbody> </table>	Connector wiring				Wire	Pin	Function		YE	1	not connected		BN	2	VDC		WH	3	GND		GN	4	SIG
Connector wiring																								
	Wire	Pin	Function																					
	YE	1	not connected																					
	BN	2	VDC																					
	WH	3	GND																					
	GN	4	SIG																					
DT connector system G (A...G)																								
	<ul style="list-style-type: none"> • Single lead wires 0.22 mm² • Attached DT compatible connector • Sealing IP69K (with or without mating connector) • Wiring sequence controlled at sensor <table border="1" style="width: 100%; border-collapse: collapse;"> <thead> <tr> <th colspan="3" style="background-color: #cccccc;">Connector wiring</th> </tr> <tr> <th style="width: 20%;"></th> <th style="width: 15%;">Wire</th> <th style="width: 15%;">Pin</th> <th style="width: 50%;">Function</th> </tr> </thead> <tbody> <tr> <td style="text-align: center;"></td> <td>BN</td> <td>1</td> <td>VDC</td> </tr> <tr> <td></td> <td>YE</td> <td>2</td> <td>not connected</td> </tr> <tr> <td></td> <td>WH</td> <td>3</td> <td>GND</td> </tr> <tr> <td></td> <td>GN</td> <td>4</td> <td>SIG</td> </tr> </tbody> </table>	Connector wiring				Wire	Pin	Function		BN	1	VDC		YE	2	not connected		WH	3	GND		GN	4	SIG
Connector wiring																								
	Wire	Pin	Function																					
	BN	1	VDC																					
	YE	2	not connected																					
	WH	3	GND																					
	GN	4	SIG																					
DT connector system H (A...H)																								
	<ul style="list-style-type: none"> • Single lead wires 0.22 mm² • Attached DT compatible connector • Sealing IP69K (with or without mating connector) • Wiring sequence controlled at sensor <table border="1" style="width: 100%; border-collapse: collapse;"> <thead> <tr> <th colspan="3" style="background-color: #cccccc;">Connector wiring</th> </tr> <tr> <th style="width: 20%;"></th> <th style="width: 15%;">Wire</th> <th style="width: 15%;">Pin</th> <th style="width: 50%;">Function</th> </tr> </thead> <tbody> <tr> <td style="text-align: center;"></td> <td>BN</td> <td>1</td> <td>VDC</td> </tr> <tr> <td></td> <td>GN</td> <td>2</td> <td>SIG</td> </tr> <tr> <td></td> <td>WH</td> <td>3</td> <td>GND</td> </tr> <tr> <td></td> <td>YE</td> <td>4</td> <td>not connected</td> </tr> </tbody> </table>	Connector wiring				Wire	Pin	Function		BN	1	VDC		GN	2	SIG		WH	3	GND		YE	4	not connected
Connector wiring																								
	Wire	Pin	Function																					
	BN	1	VDC																					
	GN	2	SIG																					
	WH	3	GND																					
	YE	4	not connected																					

Fig. 8: Connector wiring

Controlling design dimensions are in millimeters

Connection schematics

To ensure proper operation of the sensor, the hydraulic cylinder must be connected to the machine ground. Grounding is often ensured by the mechanical contact between the cylinder and other machine elements. If the cylinder is connected with the machine separately, separate grounding, for example via a grounding strap directly on the cylinder must be ensured.

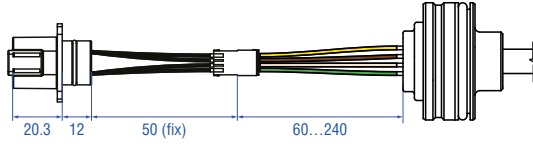
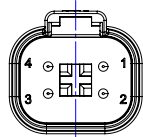
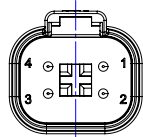
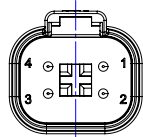
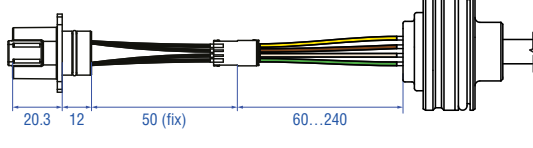
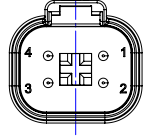
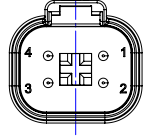
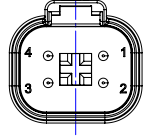
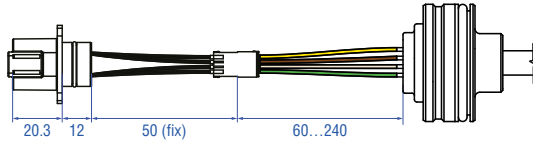
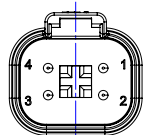
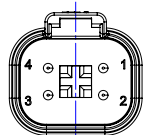
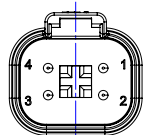
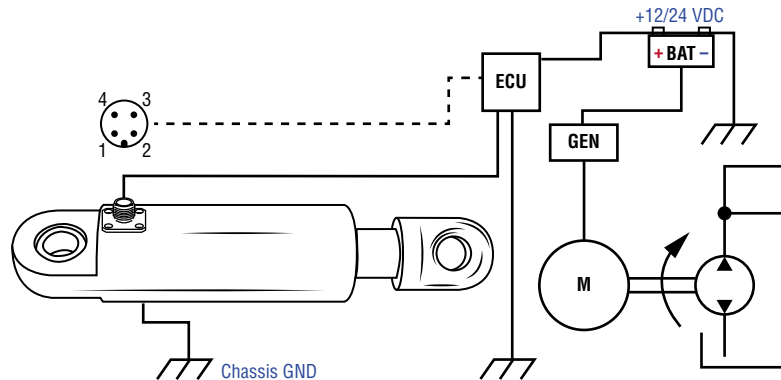

Fig. 9: Connection schematics

MECHANICAL INSTALLATION

Installation in a hydraulic cylinder

The robust Temposonics® MH sensor is designed for direct stroke measurement in hydraulic cylinders.

The Temposonics® MH sensor can be installed from the head side or the rod side of the cylinder depending on the cylinder design. In both installation methods, the sensor seals the cylinder by using an O-ring and backup ring which is installed on the sensor housing.

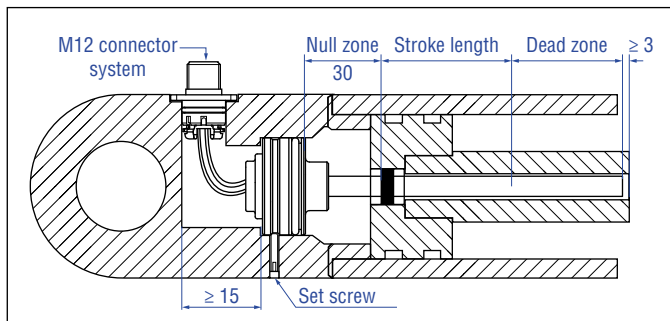

Fig. 10: Example of In-Cylinder assembly with M12 connector system

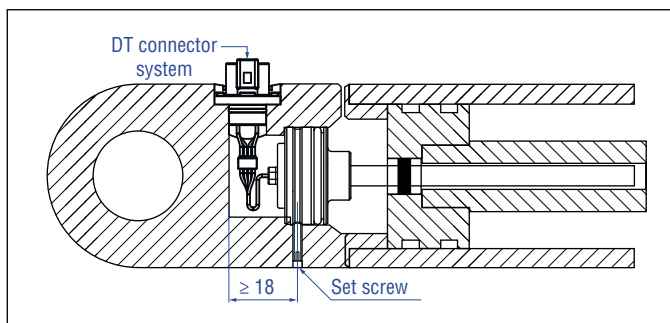

Fig. 11: Example of In-Cylinder assembly with DT connector system

NOTICE

Installation Manual for MH sensors ([document part no. 551289](#))
Installation Manual for DT connector system
([document part no. 552093](#))

NOTICE

Sealing:

- Take action against water ingress by sealing the cavity on the cover side.
- Cable glands should have IP69K rating.

Pressure:

- Do not exceed the operating pressure.

Avoid part collision:

- The bore depth in piston:
Null zone + stroke length + dead zone + > 3 mm
- The position magnet shall not touch the pressure pipe.
- Note the piston rod drilling:
- Ø 7 mm rod: ≥ Ø 10 mm
- Ø 10 mm rod: ≥ Ø 13 mm

Space requirements

M12 connector system / cable outlet

B	D	d	H	h
52 mm	48H8	> 32.5 mm < 40 mm	21.2 mm	> 15 mm

DT connector system

B	D	d	H	h
52 mm	48H8	> 32.5 mm < 40 mm	21.2 mm	> 18 mm

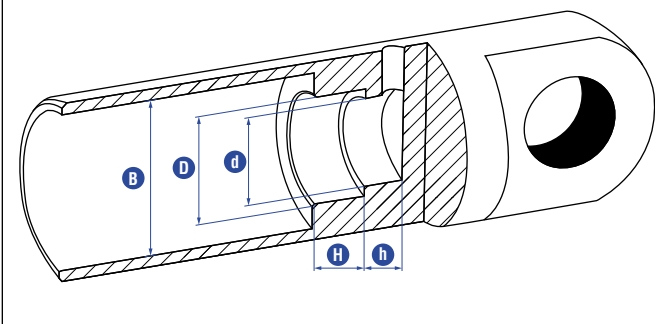

Fig. 12: Space requirements for cylinder

Set screw

e.g. retaining with set screw (with flat point) ISO 4026 M5×10 (DIN 913).
Fastening torque: ≤ 0.5 Nm

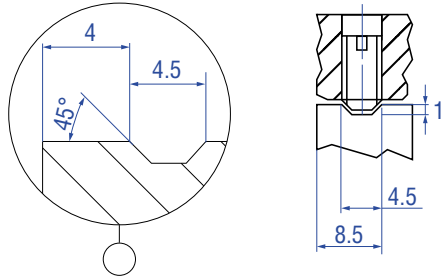

Fig. 13: Set screw

NOTICE

Avoid sensor damage:

- The screw may touch the sensor housing.
- Tightening torque: ≤ 0.5 Nm.

Lock set screw:

- Lock the set screw against falling out.
- Make sure that the threads are free of oil, grease and dirt.

Sealing:

- Consider a seal against water ingress (capillary effect).

MECHANICAL INSTALLATION – POSITION MAGNET

Magnet installation

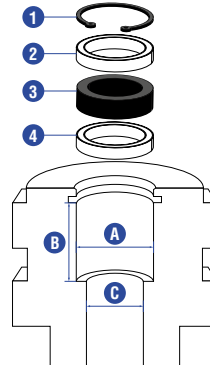

- 1 Circlip
- 2 Non-magnetic spacer
- 3 Position magnet
- 4 Non-magnetic spacer (≥ 5 mm)

Position magnet (Part no.)

	401 032	400 533	201 542-2
A	17.4 mm	25.4 mm	32.8 mm
B	≥ 18 mm	≥ 18 mm	≥ 18 mm
C	Rod Ø 7 mm →	Piston rod drilling ≥ Ø 10 mm	
	Rod Ø 10 mm →	Piston rod drilling ≥ Ø 13 mm	

Fig. 14: Dimensions for magnet mounting

NOTICE

Spacers, circlip, pretension parts etc. are not part of Temposonics shipment!

ORDER CODE

1	2	3	4	5	6	7	8	9	10	11	12	13	14	15	16	17	18
M	H						M					3					
a		b	c					d				e	f			g optional	

a	Sensor model
M H	Pressure fit flange

b	Design
Ø 10 mm rod	
C	Rod: Ø 10 mm + flat end plug / Dead zone: 63.5 mm / Stroke length: 50...2500 mm
E	Rod: Ø 10 mm + flat end plug / Dead zone: 36.5 mm / Stroke length: 50...1200 mm
L	Rod: Ø 10 mm + end plug with female M6 thread / Dead zone: 69.5 mm / Stroke length: 50...2500 mm
R	Rod: Ø 10 mm + end plug with female M4 thread / Dead zone: 69.5 mm / Stroke length: 50...2500 mm
Ø 7 mm rod	
D	Rod: Ø 7 mm + flat end plug / Dead zone: 63.5 mm / Stroke length: 50...2500 mm
F	Rod: Ø 7 mm + flat end plug / Dead zone: 36.5 mm / Stroke length: 50...1200 mm

c	Stroke length
X X X X M	0050...2500 mm

d	Electrical wiring
M12 connector system (VDC – GND – SIG) incl. flange	
N	60...240 mm wire length (in 20 mm steps) Connector wiring E: 2-3-4
N	60...240 mm wire length (in 20 mm steps) Connector wiring G: 1-3-4
N	60...240 mm wire length (in 20 mm steps) Connector wiring H: 1-3-2
Single wires	
N	60...240 mm wire length (in 20 mm steps)
Cable outlet	
T	300...9900 mm cable length (in 100 mm steps)
DT connector system (VDC – GND – SIG)	
A	60...240 mm wire length (in 20 mm steps) Connector wiring E: 2-3-4
A	60...240 mm wire length (in 20 mm steps) Connector wiring G: 1-3-4
A	60...240 mm wire length (in 20 mm steps) Connector wiring H: 1-3-2

e	Operating voltage
3	12/24 VDC nominal (8...32 VDC)

f	Output
V 0 2	0.5...9.5 VDC
V 1 1	0.25...4.75 VDC
V 1 2	0.5...4.5 VDC
V 1 3	4.75... 0.25 VDC
V 1 4	4.5... 0.5 VDC
A 0 1	4...20 mA
A 0 4	20...4 mA

optional

k	Conical end plug
K 1	Conical end plug for design C, D, E, F

NOTICE

The dead zone for designs with Ø 10 mm (C, E) will be extended by 2 mm!
The dead zone for designs with Ø 7 mm (D, F) will be extended by 2.5 mm!



DELIVERY



- Position sensor
 - O-ring
 - backup-ring
 - M12 connector system incl. M12 flange (when option selected)
 - DT connector system incl. connector assembly and retainer (when option selected)
- Accessories (e.g. position magnets) have to be ordered separately

Manuals, Software & 3D models available at:
www.temposonics.com

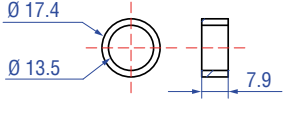
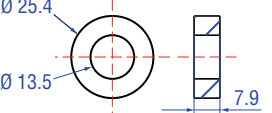
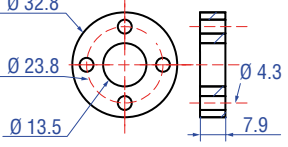
FREQUENTLY ORDERED ACCESSORIES

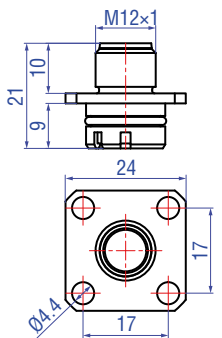
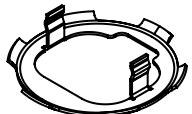
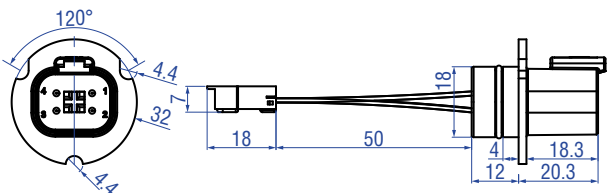
Position magnets			Test kit
			
Ring magnet OD17.4 Part no. 401 032 Material: PA neobond Weight: Approx. 5 g Surface pressure: Max. 20 N/mm ² Operating temperature: -40...+105 °C (-40...+221 °F)	Ring magnet OD25.4 Part no. 400 533 Material: PA ferrite Weight: Approx. 10 g Surface pressure: Max. 40 N/mm ² Operating temperature: -40...+105 °C (-40...+221 °F)	Ring magnet OD33 Part no. 201 542-2 Material: PA ferrite GF20 Weight: Approx. 14 g Surface pressure: Max. 40 N/mm ² Fastening torque for M4 screws: 1 Nm Operating temperature: -40...+105 °C (-40...+221 °F)	MH test kit (analog) Part no. 280 618 Kit includes: <ul style="list-style-type: none"> • 12 VDC battery charger with adapter (EU & UK) • Cable with pigtailed wires • Carrying case
Connector accessories			
			
M12 Flange Part no. 253 769 Material: Brass, nickel-plated Weight: Approx. 5 g Operating temperature: -40...+105 °C (-40...+221 °F)	DT connector system retainer Part no. 520 101 Material: 1.4310 Weight: Ca. 1.7 g Operating temperature: -40...+105 °C (-40...+221 °F)	DT connector assembly Part no. 255 098 Material: PA66 Weight: Approx. 6 g Operating temperature: -40...+105 °C (-40...+221 °F)	

Cables



Cable with M12 A-coded female connector (5 pin), straight – pigtail
Part no. 370 673

Material: PUR jacket; black
Features: Shielded
Cable length: 5 m (16.4 ft)
Ingress protection: IP67 (correctly fitted)
Operating temperature:
-25...+80 °C (-13...+176 °F)

Wiring			
Wires	Color	Pin	M12 A-coded female connector (5 pin)
	BN	↔ 1	
	WH	↔ 2	
	BU	↔ 3	
	BK	↔ 4	
	GY	↔ 5	



Cable with M12 A-coded female connector (5 pin), angled – pigtail
Part no. 370 675

Material: PUR jacket; black
Features: Shielded
Cable length: 5 m (16.4 ft)
Ingress protection: IP67 (correctly fitted)
Operating temperature:
-25...+80 °C (-13...+176 °F)

Wiring			
Wires	Color	Pin	M12 A-coded female connector (5 pin)
	BN	↔ 1	
	WH	↔ 2	
	BU	↔ 3	
	BK	↔ 4	
	GY	↔ 5	

UNITED STATES
Temposonics, LLC
Americas & APAC Region
3001 Sheldon Drive
Cary, N.C. 27513
Phone: +1 919 677-0100
E-mail: info.us@temposonics.com

GERMANY
Temposonics
GmbH & Co. KG
EMEA Region & India
Auf dem Schüffel 9
58513 Lüdenscheid
Phone: +49 2351 9587-0
E-mail: info.de@temposonics.com

ITALY
Branch Office
Phone: +39 030 988 3819
E-mail: info.it@temposonics.com

FRANCE
Branch Office
Phone: +33 6 14 060 728
E-mail: info.fr@temposonics.com

UK
Branch Office
Phone: +44 79 21 83 05 86
E-mail: info.uk@temposonics.com

SCANDINAVIA
Branch Office
Phone: +46 70 29 91 281
E-mail: info.sca@temposonics.com

CHINA
Branch Office
Phone: +86 21 3405 7850
E-mail: info.cn@temposonics.com

JAPAN
Branch Office
Phone: +81 3 6416 1063
E-mail: info.jp@temposonics.com

Document Part Number:
551958 Revision B (EN) 03/2023



temposonics.com