

Data Sheet

R-Series V RM5 EtherCAT® Magnetostrictive Linear Position Sensors

- Super shield housing with IP68/IP69 against ingress of dust and water
- Minimum position resolution 0.5 μm with down to 100 μs cycle time
- Position, velocity and acceleration measurements for up to 30 magnets



V
THE NEW GENERATION

MEASURING TECHNOLOGY

The absolute, linear position sensors provided by Temposonics rely on the company's proprietary magnetostrictive technology, which can determine position with a high level of precision and robustness. Each Temposonics® position sensor consists of a ferromagnetic waveguide, a position magnet, a strain pulse converter and supporting electronics. The magnet, connected to the object in motion in the application, generates a magnetic field at its location on the waveguide. A short current pulse is applied to the waveguide. This creates a momentary radial magnetic field and torsional strain on the waveguide. The momentary interaction of the magnetic fields releases a torsional strain pulse that propagates the length of the waveguide. When the ultrasonic wave reaches the beginning of the waveguide it is converted into an electrical signal. Since the speed of the ultrasonic wave in the waveguide is precisely known, the time required to receive the return signal can be converted into a linear position measurement with both high accuracy and repeatability.

R-SERIES V RM5 EtherCAT®

The Temposonics® R-Series V brings very powerful sensor performance to meet the many demands of your application. The RM5 sensor is the version of the RH5 rod sensor in a protective housing (super shield housing). The main advantages of the RM5 are:



Protection against corrosion

The housing made of high-quality stainless steel offers very good corrosion resistance. Thus, you can use the R-Series V also in aggressive environments.

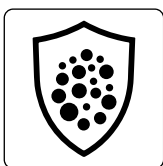

Protection against ingress of dust

The housing protects the internal sensor against penetration of dust. This maintains the sensor's performance even in heavy dust.

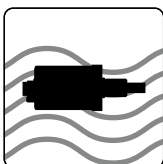

Protection against ingress of water

The housing protects the internal sensor when submerged. This allows you to use the R-Series V even under water.

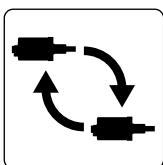

Easy and fast replacement

If necessary, the sensor inside the housing can be replaced easily and fast. This saves time and downtime costs.

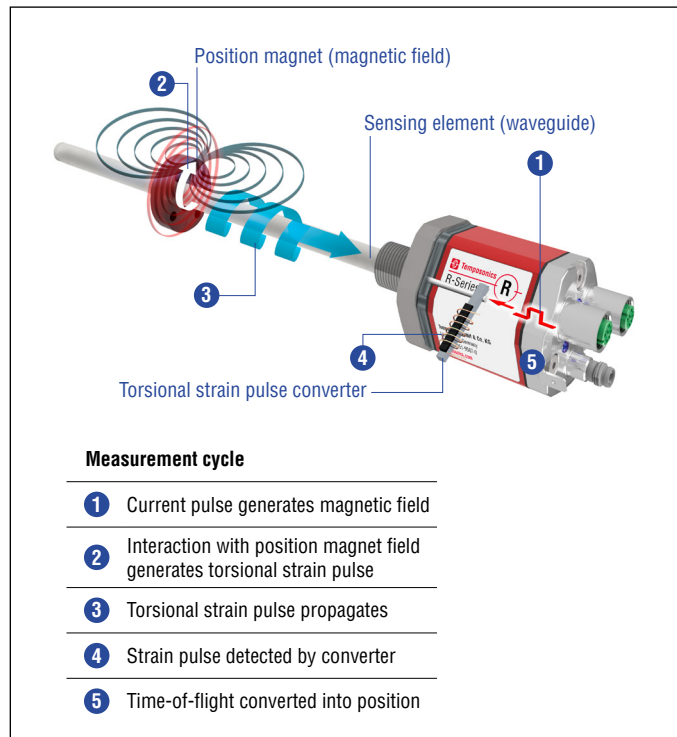
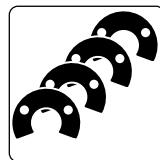

Fig. 1: Time-of-flight based magnetostrictive position sensing principle

In addition the R-Series V EtherCAT® scores with the following features:



30 positions simultaneously

The R-Series V EtherCAT® can detect and report the position, velocity and acceleration of up to 30 magnets simultaneously.



R-Series V EtherCAT®

In addition to the measured position value via the EtherCAT® protocol further data about the current sensor status, such as the total distance travelled, the internal temperature and the total operating hours, can be displayed for diagnostic purposes.

All settings under control with the smart assistants for the R-Series V

The TempoLink® and the TempoGate® smart assistants support you in setup and diagnostics of the R-Series V. For more information of these assistants please see the data sheets:

- TempoLink® smart assistant
(Document part number: [552070](#))
- TempoGate® smart assistant
(Document part number: [552110](#))



TECHNICAL DATA

Output						
Interface	EtherCAT® Ethernet Control Automation Technology					
Data protocol	EtherCAT® 100 Base-Tx, Fast Ethernet					
Data transmission rate	100 MBit/s (maximum)					
Measured value	Position, velocity and acceleration/option: Simultaneous multi-position, multi-velocity and multi-acceleration measurements up to 30 magnets					
Measurement parameters						
Resolution: Position	0.5...1000 µm (selectable)					
Native cycle time	Stroke length	≤ 50 mm	≤ 715 mm	≤ 2000 mm	≤ 4675 mm	≤ 7615 mm
	Cycle time	250 µs	500 µs	1000 µs	2000 µs	4000 µs
Extrapolation cycle time	Number of magnets	≤ 10 magnets	11...30 magnets			
	Cycle time	100 µs	250 µs			
Linearity deviation ¹	Stroke length	≤ 500 mm	> 500 mm			
	Linearity deviation	≤ ±50 µm	< 0.01 % F.S.			
	Optional internal linearity: Linearity tolerance (Applies for the first magnet for multi-position measurement)					
	Stroke length	25...300 mm	300...600 mm	600...1200 mm		
	typical	±15 µm	±20 µm	±25 µm		
	maximum	±25 µm	±30 µm	±50 µm		
Repeatability	< ±0.001 % F.S. (minimum ±2.5 µm)					
Hysteresis	< 4 µm typical					
Temperature coefficient	< 15 ppm/K typical					
Operating conditions						
Operating temperature	-40...+85 °C (-40...+185 °F)					
Humidity	100 % relative humidity, no condensation					
Ingress protection	IP68 (3 m/180 d)/IP69					
Shock test	100 g/6 ms, IEC standard 60068-2-27					
Vibration test	10 g/10...2000 Hz, IEC 60068-2-6 (excluding resonant frequencies)					
EMC test	Electromagnetic emission according to EN 61000-6-3					
	Electromagnetic immunity according to EN 61000-6-2					
	The RM5 sensors fulfill the requirements of the EMC directives 2014/30/EU, UKSI 2016 No. 1091 and TR CU 020/2011					
Operating pressure	350 bar (5076 psi)/700 bar (10,153 psi) peak (at 10 × 1 min) for sensor rod					
Magnet movement velocity	Any					
Design/Material						
Sensor electronics housing	Stainless steel 1.4404 (AISI 316L)					
Sensor flange	Stainless steel 1.4404 (AISI 316L)					
Sensor rod	Stainless steel 1.4404 (AISI 316L)					
RoHS compliance	The used materials are compliant with the requirements of EU directive 2011/65/EU and EU regulation 2015/863 as well as UKSI 2022 No. 622					
Stroke length	25...7615 mm (1...299.8 in.)					
Mechanical mounting						
Mounting position	Any					
Mounting instruction	Please consult the technical drawings and the operation manual (document number: 552059)					
Electrical connection						
Connection type	2 × cable with M12 female connector (D-coded), 1 × cable					
Operating voltage	+12...30 VDC ±20 % (9.6...36 VDC); The RM5 sensors must be power supplied via an external Class 2 power source in accordance with the UL approval					
Power consumption	Less than 4 W typical					
Dielectric strength	500 VDC (DC ground to machine ground)					
Polarity protection	Up to -36 VDC					
Overvoltage protection	Up to 36 VDC					

1/ With position magnet # 251 416-2

TECHNICAL DRAWING

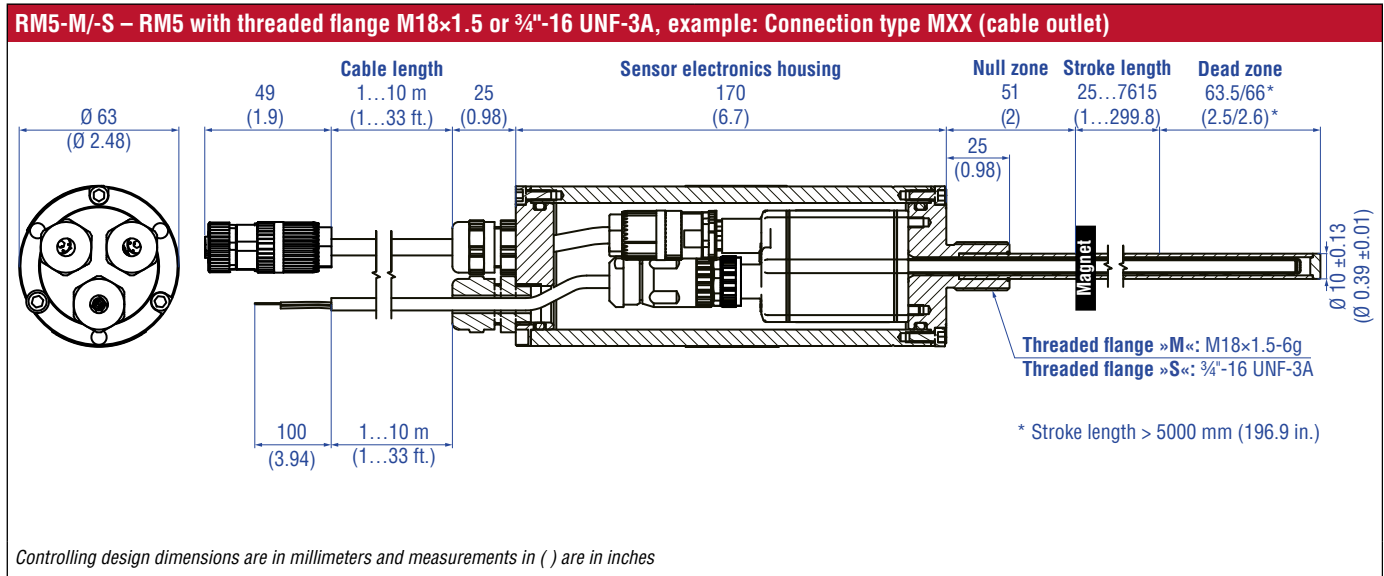

Fig. 2: Temposonics® RM5 with ring magnet

STRUCTURE

The RM5 EtherCAT® consists of (Fig. 3):

- 1 Super shield housing
- 2 R-Series V sensor with connector outlet (connection type D58)
- 3 Cable for direct connection to the controller (connection type MXX)

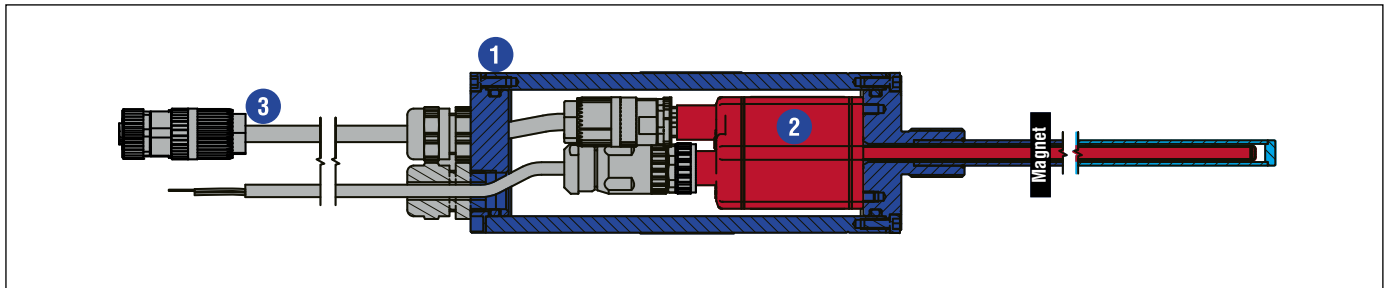

Fig. 3: Structure of RM5 EtherCAT®

CONNECTOR WIRING



MXX		
Port 1 – Signal		
M12 female connector (D-coded)	Pin	Function
 <p>View on sensor</p>	1	Tx (+)
	2	Rx (+)
	3	Tx (-)
	4	Rx (-)
Port 2 – Signal		
M12 female connector (D-coded)	Pin	Function
 <p>View on sensor</p>	1	Tx (+)
	2	Rx (+)
	3	Tx (-)
	4	Rx (-)
Power supply		
Cable	Color	Function
	BN	+12...30 VDC (±20 %)
	WH	Not connected
	BU	DC Ground (0 V)
	BK	Not connected

Fig. 4: Connector wiring MXX

FREQUENTLY ORDERED ACCESSORIES – Additional options available in our [Accessories Guide](#)  [551444](#)

Position magnets			
			
<p>U-magnet OD33 Part no. 251 416-2</p> <p>Material: PA ferrite GF20 Weight: Approx. 11 g Surface pressure: Max. 40 N/mm² Fastening torque for M4 screws: 1 Nm Operating temperature: -40...+105 °C (-40...+221 °F)</p> <p>Marked version for sensors with internal linearization: Part no. 254 226</p>	<p>Ring magnet OD33 Part no. 201 542-2</p> <p>Material: PA ferrite GF20 Weight: Approx. 14 g Surface pressure: Max. 40 N/mm² Fastening torque for M4 screws: 1 Nm Operating temperature: -40...+105 °C (-40...+221 °F)</p> <p>Marked version for sensors with internal linearization: Part no. 253 620</p>	<p>Ring magnet OD25.4 Part no. 400 533</p> <p>Material: PA ferrite Weight: Approx. 10 g Surface pressure: Max. 40 N/mm² Operating temperature: -40...+105 °C (-40...+221 °F)</p> <p>Marked version for sensors with internal linearization: Part no. 253 621</p>	<p>Ring magnet Part no. 402 316</p> <p>Material: PA ferrite coated Weight: Approx. 13 g Surface pressure: Max. 20 N/mm² Operating temperature: -40...+100 °C (-40...+212 °F)</p>

Position magnet	Magnet spacer	O-rings	
			
<p>Block magnet L Part no. 403 448</p> <p>Material: Plastic carrier with neodymium magnet Weight: Approx. 20 g Fastening torque for M4 screws: 1 Nm Operating temperature: -40...+75 °C (-40...+167 °F)</p> <p>This magnet may influence the sensor performance specifications for some applications.</p>	<p>Magnet spacer Part no. 400 633</p> <p>Material: Aluminum Weight: Approx. 5 g Surface pressure: Max. 20 N/mm² Fastening torque for M4 screws: 1 Nm</p>	<p>O-ring for threaded flange M18x1.5-6g Part no. 401 133</p> <p>Material: Fluoroelastomer Durometer: 75 ±5 Shore A Operating temperature: -40...+204 °C (-40...+400 °F)</p>	<p>O-ring for threaded flange 3/4"-16 UNF-3A Part no. 560 315</p> <p>Material: Fluoroelastomer Durometer: 75 ±5 Shore A Operating temperature: -40...+204 °C (-40...+400 °F)</p>

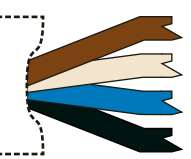
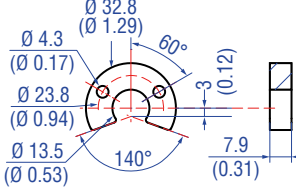
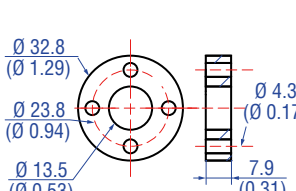
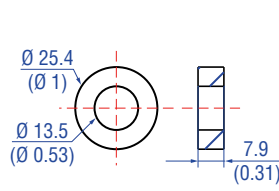
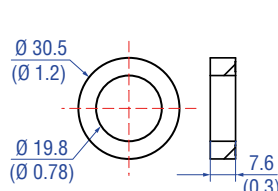
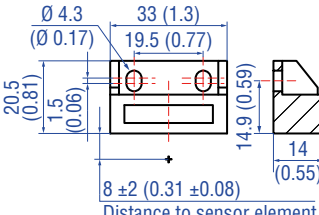
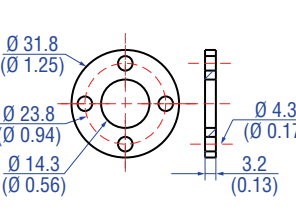
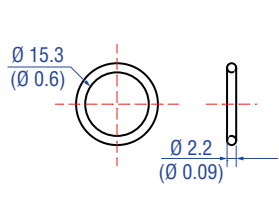
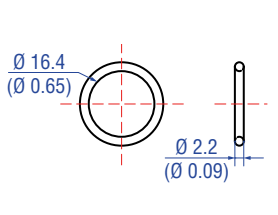
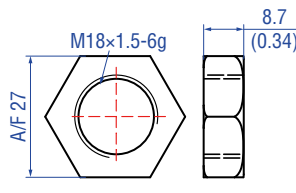
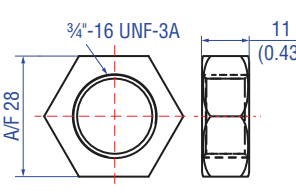
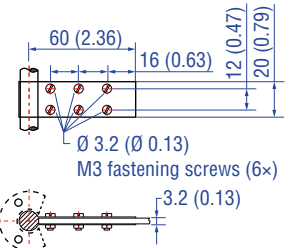
Mounting accessories		
		
<p>Hex jam nut M18x1.5-6g Part no. 500 018</p> <p>Material: Steel, zinc plated</p>	<p>Hex jam nut 3/4"-16 UNF-3A Part no. 500 015</p> <p>Material: Steel, zinc plated</p>	<p>Fixing clip Part no. 561 481</p> <p>Application: Used to secure sensor rods (Ø 10 mm (Ø 0.39 in.)) when using an U-magnet or block magnet Material: Brass, non-magnetic</p>

Cable connectors* – Signal

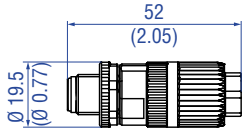

M12 D-coded male connector (4 pin), straight
Part no. 370 523

Material: Zinc nickel-plated
Termination: Insulation-displacement
Cable Ø: 6...7.2 mm (0.2...0.28 in.)
Wire: 24 AWG – 22 AWG
Operating temperature:
–25...+85 °C (–13...+185 °F)
Ingress protection: IP65 / IP67 (correctly fitted)
Fastening torque: 0.6 Nm

Cable connectors* – Power

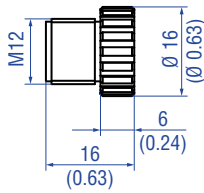

M12 connector end cap
Part no. 370 537

Female connectors M12 should be covered by this protective cap
Material: Brass nickel-plated
Ingress protection: IP67 (correctly fitted)
Fastening torque: 0.39...0.49 Nm

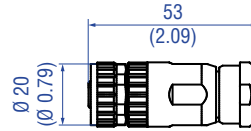

M12 A-coded female connector (4 pin/5 pin), straight
Part no. 370 677

Material: GD-Zn, Ni
Termination: Screw
Contact insert: CuZn
Cable Ø: 4...8 mm (0.16...0.31 in.)
Wire: max. 1.5 mm² (16 AWG)
Operating temperature:
–30...+85 °C (–22...+185 °F)
Ingress protection: IP67 (correctly fitted)
Fastening torque: 0.6 Nm

Cables

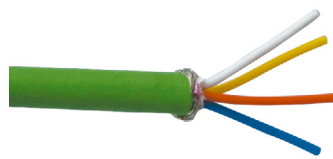

PUR signal cable
Part no. 530 125

Material: PUR jacket; green
Features: Cat 5, highly flexible, halogen free, suitable for drag chains, mostly oil & flame resistant
Cable Ø: 6.5 mm (0.26 in.)
Cross section: 2 × 2 × 0.35 mm² (22 AWG)
Bending radius: 6 × D (fixed installation)
Operating temperature:
–20...+60 °C (–4...+140 °F)



PVC power cable
Part no. 530 108

Material: PVC jacket; gray
Features: Shielded, flexible, mostly flame resistant
Cable Ø: 4.9 mm (0.19 in.)
Cross section: 3 × 0.34 mm²
Bending radius: 5 × D (fixed installation)
Operating temperature:
–30...+80 °C (–22...+176 °F)

Cable sets



Signal cable with M12 D-coded male connector (4 pin), straight – M12 D-coded, male connector (4 pin), straight
Part no. 530 064



Material: PUR jacket; green
Feature: Cat 5e
Cable length: 5 m (16.4 ft)
Cable Ø: 6.5 mm (0.26 in.)
Ingress protection: IP65, IP67, IP68 (correctly fitted)
Operating temperature:
–30...+70 °C (–22...+158 °F)



Signal cable with M12 D-coded male connector (4 pin), straight – RJ45 male connector, straight
Part no. 530 065

Material: PUR jacket; green
Feature: Cat 5e
Cable length: 5 m (16.4 ft)
Cable Ø: 6.5 mm (0.26 in.)
Ingress protection M12 connector: IP67 (correctly fitted)
Ingress protection RJ45 connector: IP20 (correctly fitted)
Operating temperature:
–30...+70 °C (–22...+158 °F)

*/ Follow the manufacturer's mounting instructions
Controlling design dimensions are in millimeters and measurements in () are in inches
Color of connectors and cable jacket may change. Color codes for the individual wires and technical properties remain unchanged.

Cable sets	Programming tools	
		
<p>Power cable with M12 A-coded female connector (5 pin), straight – pigtail Part no. 370 673</p>	<p>TempoLink® kit for Temposonics® R-Series V Part no. TL-1-0-EM08 (D56) Part no. TL-1-0-EM12 (D58)</p>	<p>TempoGate® smart assistant for Temposonics® R-Series V Part no. TG-C-0-Dxx (xx indicates the number of R-Series V sensors that can be connected (even numbers only))</p>
<p>Material: PUR jacket; black Feature: Shielded Cable length: 5 m (16.4 ft) Ingress protection: IP67 (correctly fitted) Operating temperature: -25...+80 °C (-13...+176 °F)</p>	<ul style="list-style-type: none"> • Connect wirelessly via Wi-Fi enabled device or via USB with the diagnostic tool • Simple connectivity to the sensor via 24 VDC power line (permissible cable length: 30 m) • User friendly interface for mobile devices and desktop computers • See data sheet “TempoLink® smart assistant” (document part no.: 552070) for further information 	<ul style="list-style-type: none"> • OPC UA server for diagnostics of the R-Series V • For installation in the control cabinet • Connection via LAN and Wi-Fi • See data sheet “TempoGate® smart assistant” document part no.: 552110 for further information

Color of connectors and cable jacket may change. Color codes for the individual wires and technical properties remain unchanged.

ORDER CODE

1	2	3	4	5	6	7	8	9	10	11	12	13	14	15	16	17	18	19	20
R	M	5		A											1	U	1		1
a			b	c	d					e	f			g	h				

a	Sensor model
R M 5	Super shield housing

b	Design
M	Threaded flange M18×1.5-6g (standard)
S	Threaded flange ¾"-16 UNF-3A (standard)

c	Mechanical options
A	Standard

d	Stroke length
X X X X M	0025...7615 mm

Standard stroke length (mm)	Ordering steps
25... 500 mm	5 mm
500... 750 mm	10 mm
750...1000 mm	25 mm
1000...2500 mm	50 mm
2500...5000 mm	100 mm
5000...7615 mm	250 mm

X X X X U	001.0...299.8 in.
-----------	-------------------

Standard stroke length (in.)	Ordering steps
1... 20 in.	0.2 in.
20... 30 in.	0.4 in.
30... 40 in.	1.0 in.
40...100 in.	2.0 in.
100...200 in.	4.0 in.
200...299.8 in.	10.0 in.

Non-standard stroke lengths are available; must be encoded in 5 mm/0.1 in. increments.

e	Number of magnets
X X	01...30 position(s) (1...30 magnet(s))

f	Connection type
M X X	2 × XX m/ft. PUR cable (part no. 530 125) for data lines with M12 female connector (part no. 370 830) and 1 × XX m/ft. PVC cable (part no. 530108) for power supply M01...M10 (1...10 m/1...33 ft.) See "Frequently ordered accessories" for cable & connector specifications
Encode in meters if using metric stroke length Encode in feet if using US customary stroke length	



g	System
1	Standard

h	Output
U 1 0 1	EtherCAT®, position, velocity and acceleration (1...30 magnet(s))
U 1 1 1	EtherCAT®, position, velocity and acceleration internal linearization (1...30 magnet(s))

NOTICE

- Specify number of magnets for your application and order the magnets separately.
- The number of magnets is limited by the stroke length. The minimum allowed distance between magnets (i.e. front face of one to the front face of the next one) is 75 mm (3 in.).
- Use magnets of the same type for multi-position measurement..
- If the option for internal linearization (U111) in **h** "Output" is chosen, select a suitable magnet.

DELIVERY

-  Sensor
 -  O-ring
- Accessories have to be ordered separately.

Manuals, Software & 3D Models available at:
www.temposonics.com

GLOSSARY

D

Distributed Clock

EtherCAT® uses a logical network of **Distributed Clocks (DC)** to synchronize the time on all local bus devices on the network. The EtherCAT® master usually selects the first Distributed Clock capable slave device as a Reference Clock, and then maintains a precise mapping of frame delays for all other slave devices in order to adjust their time to match the system time.

E

ESI

The properties and functions of an EtherCAT® device are described in an ESI file (**EtherCAT® Slave Information**). The XML-based ESI file contains all relevant data that are important for the implementation of the device in the controller as well as for data exchange during operation. The ESI file of the R-Series V EtherCAT® is available on the homepage www.temposonics.com.

EtherCAT®

EtherCAT® (**Ethernet for Control Automation Technology**) is an Industrial Ethernet interface and is managed by the **EtherCAT® Technology Group (ETG)**. The R-Series V EtherCAT® and its corresponding ESI file are certified by the ETG.

Extrapolation

The native measurement cycle time of a sensor increases with the stroke length. With extrapolation, the sensor is able to report data faster than the native cycle time, independent of the stroke length of the sensor. Without extrapolation, if data is requested faster than the native cycle time, the last measured value is repeated.

I

Internal Linearization

The internal linearization offers an improved linearity for an overall higher accuracy of the position measurement. The internal linearization is set for the sensor during production.

M

Multi-position measurement

During the measurement cycle, the positions of every magnet on the sensor are simultaneously reported. The velocity and acceleration are continuously calculated based on these changing position values as the magnets are moved.

UNITED STATES
Temposonics, LLC
Americas & APAC Region
3001 Sheldon Drive
Cary, N.C. 27513
Phone: +1 919 677-0100
E-mail: info.us@temposonics.com

GERMANY
Temposonics GmbH & Co. KG
EMEA Region & India
Auf dem Schüffel 9
58513 Lüdenscheid
Phone: +49 2351 9587-0
E-mail: info.de@temposonics.com

ITALY
Branch Office
Phone: +39 030 988 3819
E-mail: info.it@temposonics.com

FRANCE
Branch Office
Phone: +33 6 14 060 728
E-mail: info.fr@temposonics.com

UK
Branch Office
Phone: +44 79 21 83 05 86
E-mail: info.uk@temposonics.com

SCANDINAVIA
Branch Office
Phone: +46 70 29 91 281
E-mail: info.sca@temposonics.com

CHINA
Branch Office
Phone: +86 21 3405 7850
E-mail: info.cn@temposonics.com

JAPAN
Branch Office
Phone: +81 3 6416 1063
E-mail: info.jp@temposonics.com

Document Part Number:
552115 Revision A (EN) 10/2024



temposonics.com