

## Data Sheet

# R-Series V RH5 SSI

## Magnetostrictive Linear Position Sensors

**NEW!**  
Also with flexible  
sensing element  
for easy replacement

- Position measurement with a resolution up to 0.1  $\mu\text{m}$
- Update rate up to 10 kHz
- Field adjustments and diagnostics using the TempoLink<sup>®</sup> and TempoGate<sup>®</sup> smart assistants

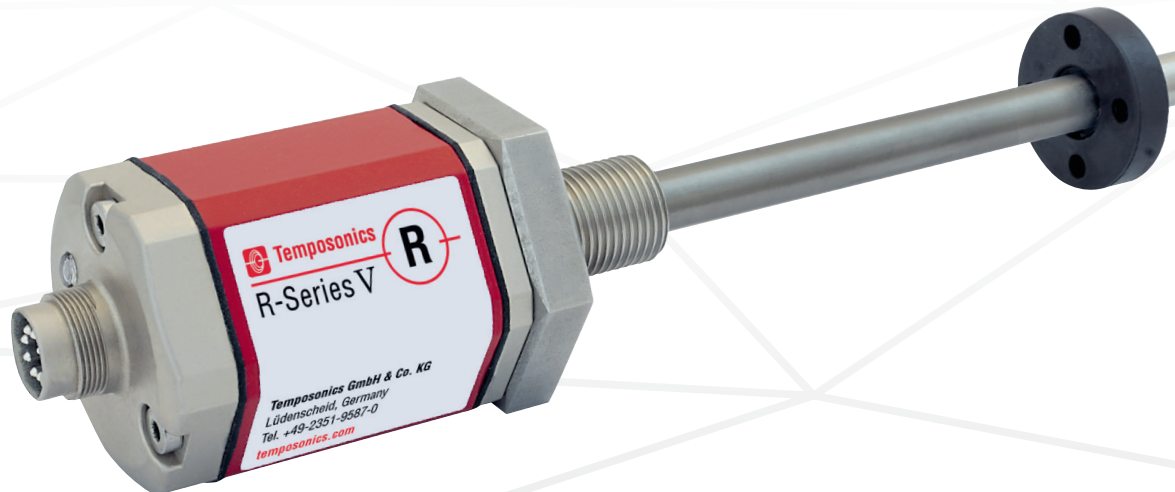

**V**  
THE NEW GENERATION

## MEASURING TECHNOLOGY

The absolute, linear position sensors provided by Temposonics rely on the company's proprietary magnetostrictive technology, which can determine position with a high level of precision and robustness. Each Temposonics® position sensor consists of a ferromagnetic waveguide, a position magnet, a strain pulse converter and supporting electronics. The magnet, connected to the object in motion in the application, generates a magnetic field at its location on the waveguide. A short current pulse is applied to the waveguide. This creates a momentary radial magnetic field and torsional strain on the waveguide. The momentary interaction of the magnetic fields releases a torsional strain pulse that propagates the length of the waveguide. When the ultrasonic wave reaches the beginning of the waveguide it is converted into an electrical signal. Since the speed of the ultrasonic wave in the waveguide is precisely known, the time required to receive the return signal can be converted into a linear position measurement with both high accuracy and repeatability.

## R-SERIES V RH5 SSI

The Temposonics® R-Series V brings very powerful sensor performance to meet the many demands of your application. The main advantages of the rod version RH5 with SSI output (Synchronous Serial Interface) are:

- 

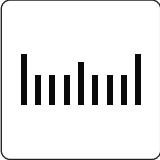
**High shock and vibration resistance**  
The R-Series V is the long term solution for harsh environments that have high levels of shock and vibration.
- 

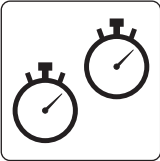
**Minimum resolution 0.1 µm**  
The sensor is characterized by a very stable position signal with a minimum resolution of 0.1 µm.
- 

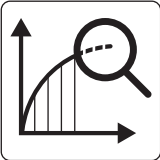
**Synchronous measurement**  
The sensor offers one asynchronous mode as well as three different synchronous modes to match the measurement to the data request cycle of the controller.
- 

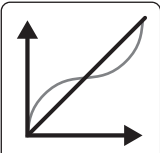
**Extrapolation**  
The sensor supports linear extrapolation. This allows a cycle time of 100 µs or the readout of the data with up to 10 kHz for any stroke length of the sensor.
- 

**Internal linearization**  
The sensor is available with internal linearization which offers improved linearity for overall higher accuracy of the position measurement value.

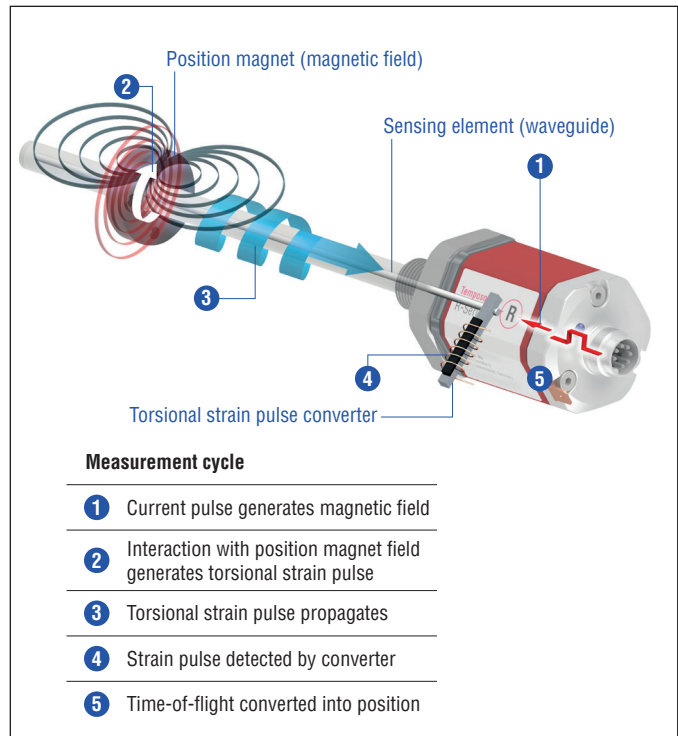
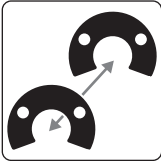



Fig. 1: Time-of-flight based magnetostrictive position sensing principle

In addition the R-Series V SSI scores with the following features:

- 

**Differential measurement between 2 positions**  
The R-Series V SSI can measure and output the distance between 2 position magnets.
- 

**R-Series V SSI**  
The interface of the R-Series V SSI corresponds to the SSI industry standard for absolute encoders. You can select the configuration of the SSI signal that fits best to your application and also adjust it on site with the sensor assistants.

**All settings under control with the smart assistants for the R-Series V**

The TempoLink® and the TempoGate® smart assistants support you in setup and diagnostics of the R-Series V. For more information of these assistants please see the data sheets:

- TempoLink® smart assistant  
(Document part number: [552070](#))
- TempoGate® smart assistant  
(Document part number: [552110](#))



## RH5 WITH RIGID OR FLEXIBLE SENSING ELEMENT – YOU DECIDE

With the RH5, you can replace the base unit when the sensor is installed in the cylinder without opening the hydraulic circuit. This is possible as the flange with the pressure tube remains in the cylinder. You decide whether the base unit of the RH5 has a rigid or a flexible sensing element:

- RH5 with rigid sensor element: RH5-B/J/M/S/T-A/B/M/V
- RH5 with flexible sensing element: RH5-B/M/S/T-F

### The advantages of the rod sensor with flexible sensing element RH5-B/M/S/T-F:

- Only a small amount of space is required when replacing the sensor as the sensing element can be bent
- It can be used as a replacement for an RH5 sensor with a rigid sensing element

#### Example: RH5-B/J/M/S/T-A/B/M/V (rigid sensing element)

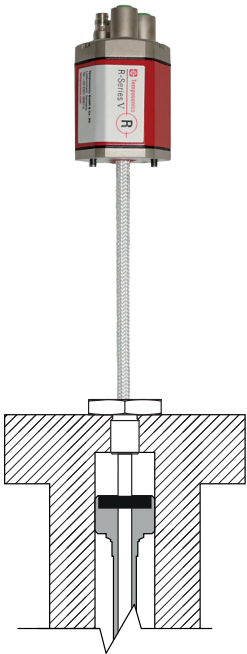

#### Example: RH5-B/M/S/T-F (flexible sensing element)

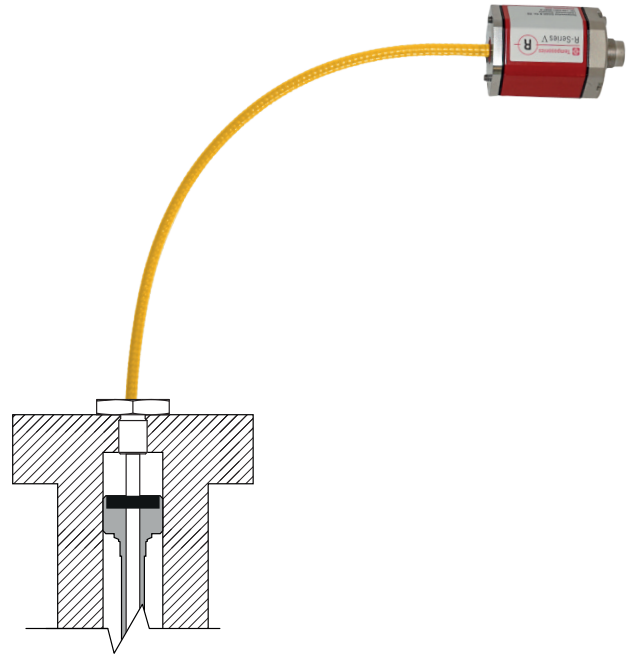

## TECHNICAL DATA

Output								
Interface	SSI (Synchronous Serial Interface) – differential signal in SSI standard (RS-485/RS-422)							
Data format	Binary or gray							
Data length	8...32 bit							
Data transmission rate	70 kBaud <sup>1</sup> ...1 MBaud, depending on cable length:							
	Cable length	< 3 m	< 50 m	< 100 m	< 200 m	< 400 m		
	Baud rate	1 MBd	< 400 kBd	< 300 kBd	< 200 kBd	< 100 kBd		
Measured value	Position or velocity, position and temperature in the sensor electronics housing							
Measurement parameters								
Resolution: Position	0.1...100 µm (0.0001...0.1 mm)							
Resolution: Velocity	0.001 mm/s (determined over 10 measured values)							
Update rate <sup>2</sup>	Stroke length	25 mm	300 mm	750 mm	1000 mm	2000 mm	7620 mm	
	Update rate	10 kHz	3.4 kHz	2.7 kHz	2.1 kHz	1.2 kHz	0.3 kHz	
Linearity deviation <sup>3</sup>	Stroke length	≤ 400 mm	> 400 mm					
	Linearity deviation	≤ ±40 µm	< ±0.01 % F.S.					
	Optional internal linearization: Linearity tolerance (applies for the first magnet for differential measurement)							
	Stroke length	25...300 mm	300...600 mm	600...1200 mm				
		typical	± 15 µm	± 20 µm	± 25 µm			
		maximum	± 25 µm	± 30 µm	± 50 µm			
Repeatability	< ±0.001 % F.S. (minimum ±2.5 µm) typical							
Hysteresis	< 4 µm typical							
Temperature coefficient	< 15 ppm/K typical							
Operating conditions								
Operating temperature	-40...+85 °C (-40...+185 °F)							
Humidity	90 % relative humidity, no condensation							
Ingress protection	IP67 (connectors correctly fitted)/IP68 (3 m/3 d) for straight cable outlet/IP68 (3 m/3 d) & IP69 for angled cable outlet							
Shock test	150 g/11 ms, IEC standard 60068-2-27							
Vibration test	30 g/10...2000 Hz, IEC standard 60068-2-6 (excluding resonant frequencies)/ RH5-J: 15 g/10...2000 Hz, IEC standard 60068-2-6 (excluding resonant frequencies)							
EMC test	Electromagnetic emission according to EN 61000-6-3 Electromagnetic immunity according to EN 61000-6-2 The RH5 sensors fulfill the requirements of the EMC directives 2014/30/EU, UKSI 2016 No. 1091 and TR CU 020/2011							
Operating pressure	350 bar (5,076 psi)/700 bar (10,153 psi) peak (at 10 × 1 min) for sensor rod/RH5-J: 800 bar (11,603 psi)							
Magnet movement velocity	Any							
Design/Material								
Sensor electronics housing	Aluminum (painted), zinc die cast							
Sensor flange	Stainless steel 1.4305 (AISI 303)							
Sensor rod	Stainless steel 1.4306 (AISI 304L)/RH5-J: Stainless steel 1.4301 (AISI 304)							
RoHS compliance	The used materials are compliant with the requirements of EU Directive 2011/65/EU and EU Regulation 2015/863 as well as UKSI 2022 No. 622 with amendments							
Stroke length	25...7620 mm (1...300 in.)/RH5-J: 25...5900 mm (1...232 in.)							

Technical data “Mechanical mounting” and “Electrical connection” on [page 5](#)

1/ With standard one shot of 16 µs

2/ Sensor with standard settings. Further information can be found in the operation manual R-Series V SSI (document part number: [552011](#))

3/ With position magnet # 251 416-2

Mechanical mounting	
Mounting position	Any
Mounting instruction	Please consult the technical drawings on <a href="#">page 6</a> and <a href="#">page 7</a> and the operation manual (document part number: <a href="#">552011</a> )
Electrical connection	
Connection type	1 × M16 male connector (7 pin), 1 × M12 male connector (8 pin) or cable outlet
Operating voltage	+12...30 VDC ±20 % (9.6...36 VDC); the RH5 sensors must be power supplied via an external Class 2 power source in accordance with the UL approval
Power consumption	1.2 W typical
Dielectric strength	500 VDC (DC ground to machine ground)
Polarity protection	Up to -36 VDC
Overvoltage protection	Up to 36 VDC

TECHNICAL DRAWING

**RH5-M/S-A/V – RH5 with threaded flange M18×1.5-6g or ¾"-16 UNF-3A, example: Connection type D70 (connector outlet)**

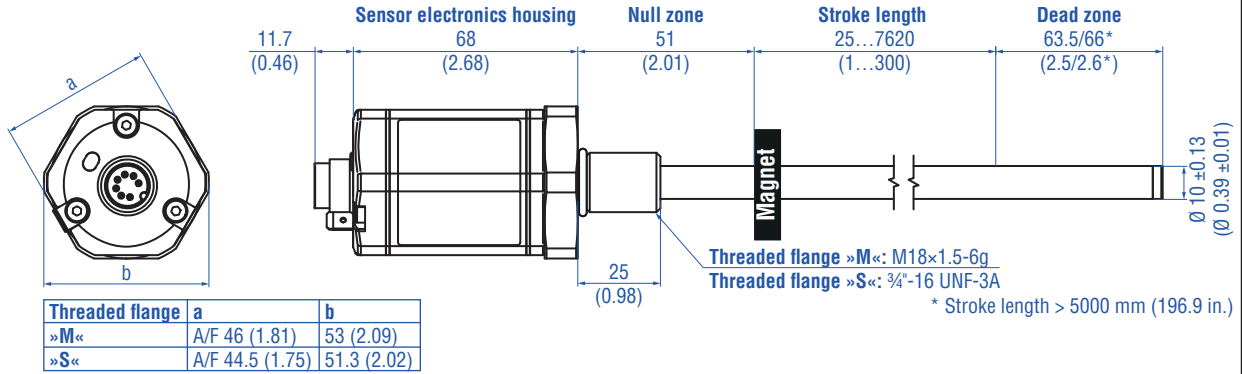

**RH5-T-A/V – RH5 with threaded flange ¾"-16 UNF-3A with raised-face, example: Connection type BXX/EXX/GXX/LXX/UXX (angled cable outlet)**

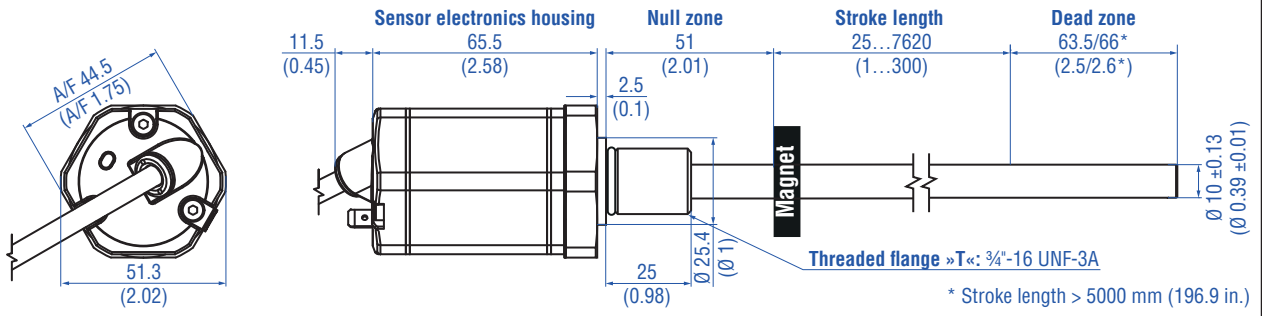

**RH5-T-A/V – RH5 with threaded flange ¾"-16 UNF-3A with raised-face, example: Connection type HXX/PXX/RXX/TXX (straight cable outlet)**

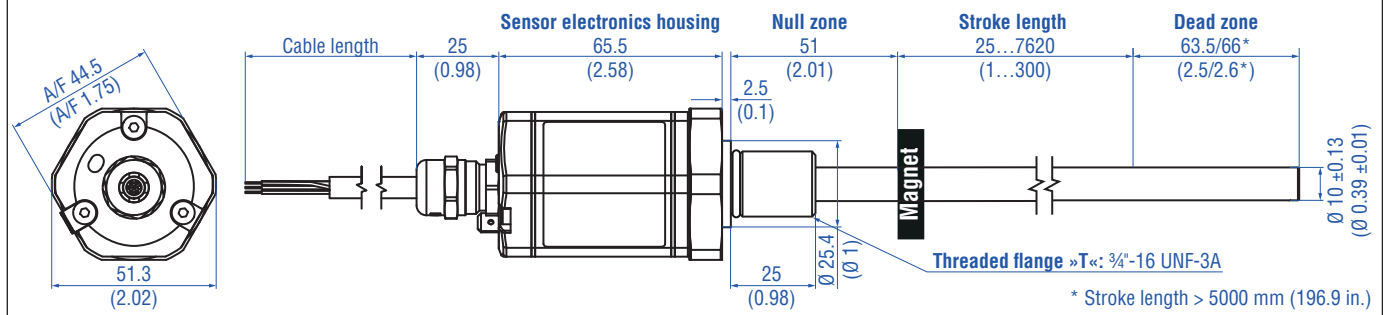

**Mechanical option »B«: Bushing on rod end for threaded flange M18×1.5-6g or ¾"-16 UNF-3A**

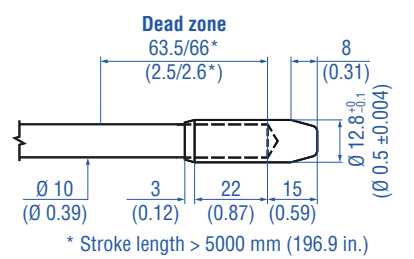

**Mechanical option »M«: Thread M4 at rod end for threaded flange M18×1.5-6g or ¾"-16 UNF-3A**

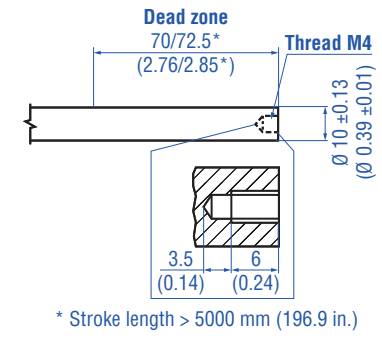

Controlling design dimensions are in millimeters and measurements in ( ) are in inches

Fig. 2: Temposonics® RH5 with ring magnet, part 1

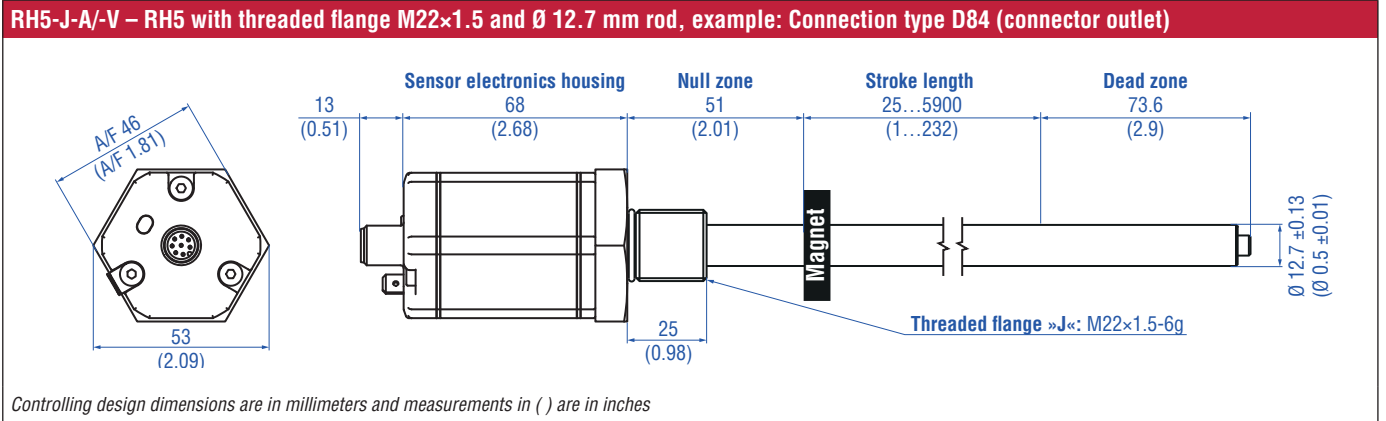

Fig. 3: Temposonics® RH5 with ring magnet, part 2

## CONNECTOR WIRING

D70		
Signal + power supply		
M16 male connector	Pin	Function
 <p>View on sensor</p>	1	Data (-)
	2	Data (+)
	3	Clock (+)
	4	Clock (-)
	5	+12...30 VDC (±20 %)
	6	DC Ground (0 V)
	7	Not connected

Fig. 4: Connector wiring D70

HXX or LXX/PXX or BXX/RXX or EXX/TXX or GXX/UXX		
Signal + power supply		
Cable	Color	Function
	GY	Data (-)
	PK	Data (+)
	YE	Clock (+)
	GN	Clock (-)
	BN	+12...30 VDC (±20 %)
	WH	DC Ground (0 V)

For cable type TXX, the extra red & blue wires are not used.

Fig. 6: Connector wiring cable outlet

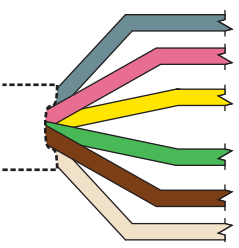
D84		
Signal + power supply		
M12 male connector (A-coded)	Pin	Function
 <p>View on sensor</p>	1	Clock (+)
	2	Clock (-)
	3	Data (+)
	4	Data (-)
	5	Not connected
	6	Not connected
	7	+12...30 VDC (±20 %)
	8	DC Ground (0 V)

Fig. 5: Connector wiring D84

Straight cable outlet			Cable type	Angled cable outlet			
<b>H</b>	<b>X</b>	<b>X</b>	Part no. 530 052 PUR →	<b>L</b>	<b>X</b>	<b>X</b>	Part no. 530 052
<b>P</b>	<b>X</b>	<b>X</b>	Part no. 530 175 PUR →	<b>B</b>	<b>X</b>	<b>X</b>	Part no. 530 175
<b>R</b>	<b>X</b>	<b>X</b>	Part no. 530 032 PVC →	<b>E</b>	<b>X</b>	<b>X</b>	Part no. 530 032
<b>T</b>	<b>X</b>	<b>X</b>	Part no. 530 112 FEP →	<b>G</b>	<b>X</b>	<b>X</b>	Part no. 530 157

Fig. 7: Cable types assignment





**FREQUENTLY ORDERED ACCESSORIES** – Additional options available in our [Accessories Catalog](#) 551444

Position magnets					
<p><b>U-magnet OD33</b> Part no. 251 416-2</p> <p>Material: PA ferrite GF20 Weight: Approx. 11 g Surface pressure: Max. 40 N/mm<sup>2</sup> Fastening torque for M4 screws: 1 Nm Operating temperature: -40...+105 °C (-40...+221 °F) Marked version for sensors with internal linearization: Part no. 254 226</p>	<p><b>Ring magnet OD33</b> Part no. 201 542-2</p> <p>Material: PA ferrite GF20 Weight: Approx. 14 g Surface pressure: Max. 40 N/mm<sup>2</sup> Fastening torque for M4 screws: 1 Nm Operating temperature: -40...+105 °C (-40...+221 °F) Marked version for sensors with internal linearization: Part no. 253 620</p>	<p><b>Ring magnet OD25.4</b> Part no. 400 533</p> <p>Material: PA ferrite Weight: Approx. 10 g Surface pressure: Max. 40 N/mm<sup>2</sup> Operating temperature: -40...+105 °C (-40...+221 °F) Marked version for sensors with internal linearization: Part no. 253 621</p>	<p><b>Ring magnet</b> Part no. 402 316</p> <p>Material: PA ferrite coated Weight: Approx. 13 g Surface pressure: Max. 20 N/mm<sup>2</sup> Operating temperature: -40...+100 °C (-40...+212 °F)</p>		
Position magnet		Magnet spacer		O-rings	
<p><b>Block magnet L</b> Part no. 403 448</p> <p>Material: Plastic carrier with neodymium magnet Weight: Approx. 20 g Fastening torque for M4 screws: 1 Nm Operating temperature: -40...+75 °C (-40...+167 °F)</p> <p>This magnet may influence the sensor performance specifications for some applications.</p>	<p><b>Magnet spacer</b> Part no. 400 633</p> <p>Material: Aluminum Weight: Approx. 5 g Surface pressure: Max. 20 N/mm<sup>2</sup> Fastening torque for M4 screws: 1 Nm</p>	<p><b>O-ring for threaded flange</b> M18×1.5-6g Part no. 401 133</p> <p>Material: Fluoroelastomer Durometer: 75 ±5 Shore A Operating temperature: -40...+204 °C (-40...+400 °F)</p>	<p><b>O-ring for threaded flange</b> ¾"-16 UNF-3A Part no. 560 315</p> <p>Material: Fluoroelastomer Durometer: 75 ±5 Shore A Operating temperature: -40...+204 °C (-40...+400 °F)</p>		
O-ring		Mounting accessories			
<p><b>O-ring for threaded flange</b> M22×1.5-6g Part no. 561 337</p> <p>Material: FPM Durometer: 75 Shore A Operating temperature: -20...+200 °C (-6...+392 °F)</p>	<p><b>Hex jam nut M18×1.5-6g</b> Part no. 500 018</p> <p>Material: Steel, zinc plated</p>	<p><b>Hex jam nut ¾"-16 UNF-3A</b> Part no. 500 015</p> <p>Material: Steel, zinc plated</p>	<p><b>Fixing clip</b> Part no. 561 481</p> <p>Application: Used to secure sensor rods (Ø 10 mm (Ø 0.39 in.)) when using an U-magnet or block magnet Material: Brass, non-magnetic</p>		

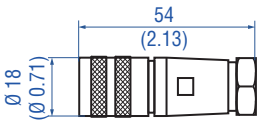
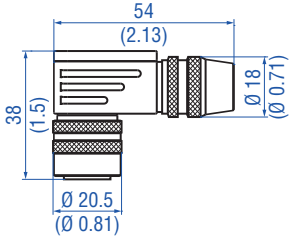
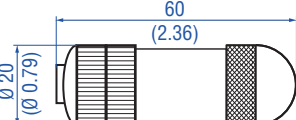
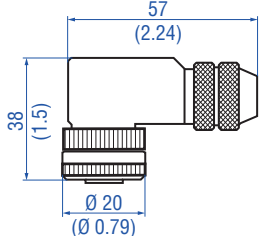
**Cable connectors\***

			
<p><b>M16 female connector (7 pin), straight</b> Part no. 370 624</p>	<p><b>M16 female connector (7 pin), angled</b> Part no. 560 779</p>	<p><b>M12 A-coded female connector (8 pin), straight</b> Part no. 370 694</p>	<p><b>M12 A-coded female connector (8 pin), angled</b> Part no. 370 699</p>
<p>Material: Zinc nickel plated Termination: Solder Contact insert: Silver plated Cable clamp: PG9 Cable Ø: 6...8 mm (0.24...0.31 in.) Operating temperature: -40...+100 °C (-40...+212 °F) Ingress protection: IP65/IP67 (correctly fitted) Fastening torque: 0.7 Nm</p>	<p>Material: Zinc nickel plated Termination: Solder Contact insert: Silver plated Cable clamp: PG9 Cable Ø: 6...8 mm (0.24...0.31 in.) Operating temperature: -40...+100 °C (-40...+212 °F) Ingress protection: IP65/IP67 (correctly fitted) Fastening torque: 0.7 Nm</p>	<p>Housing: GD-ZnAL Termination: Screw Contact insert: CuZn Cable Ø: 4...9 mm (0.16...0.35 in.) Wire: 0.75 mm<sup>2</sup> Operating temperature: -25...+90 °C (-13...+194 °F) Ingress protection: IP67 (correctly fitted) Fastening torque: 0.6 Nm</p>	<p>Housing: GD-ZnAL Termination: Screw Contact insert: CuZn Cable Ø: 6...8 mm (0.24...0.31 in.) Wire: 0.5 mm<sup>2</sup> Operating temperature: -25...+85 °C (-13...+185 °F) Ingress protection: IP67 (correctly fitted) Fastening torque: 0.6 Nm</p>

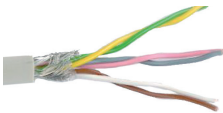
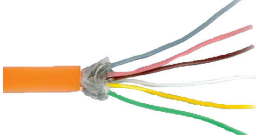
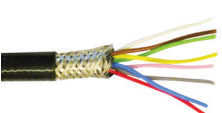
**Cables**

			
<p><b>PVC cable</b> Part no. 530 032</p>	<p><b>PUR cable</b> Part no. 530 052</p>	<p><b>FEP cable</b> Part no. 530 112</p>	<p><b>FEP cable</b> Part no. 530 157</p>
<p>Material: PVC jacket; gray Features: Twisted pair, shielded, flexible Cable Ø: 6 mm (0.23 in.) Cross section: 3 × 2 × 0.14 mm<sup>2</sup> Bending radius: 10 × D (fixed installation) Operating temperature: -40...+105 °C (-40...+221 °F)</p>	<p>Material: PUR jacket; orange Features: Twisted pair, shielded, highly flexible, halogen free, suitable for drag chains, mostly oil &amp; flame resistant Cable Ø: 6.4 mm (0.25 in.) Cross section: 3 × 2 × 0.25 mm<sup>2</sup> Bending radius: 5 × D (fixed installation) Operating temperature: -20...+80 °C (-4...+176 °F)</p>	<p>Material: FEP jacket; black Features: Twisted pair, shielded, flexible, high thermal resistance, mostly oil &amp; acid resistant Cable Ø: 7.6 mm (0.3 in.) Cross section: 4 × 2 × 0.25 mm<sup>2</sup> Bending radius: 8 – 10 × D (fixed installation) Operating temperature: -100...+180 °C (-148...+356 °F)</p>	<p>Material: FEP jacket; black Features: Twisted pair, shielded Cable Ø: 6.7 mm (0.26 in.) Cross section: 3 × 2 × 0.14 mm<sup>2</sup> Operating temperature: -40...+180 °C (-40...+356 °F)</p>

\*/ Follow the manufacturer's mounting instructions

Controlling design dimensions are in millimeters and measurements in ( ) are in inches

Color of connectors and cable jacket may change. Color codes for the individual wires and technical properties remain unchanged.

**Cables**

**Cable sets**

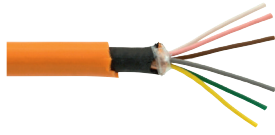

**PUR cable**  
Part no. 530 175

Material: PUR jacket; orange  
Features: Flexible, additional EMC protection  
Cable Ø: 6.5 mm (0.26 in.)  
Cross section: 6 × 0.14 mm<sup>2</sup>  
Bending radius: 10 × D (fixed installation)  
Operating temperature: -30...+90 °C (-22...+194 °F)

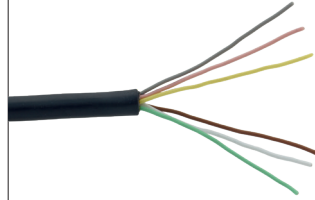

**Silicone cable**  
Part no. 530 176

Material: Silicone jacket; black  
Features: Twisted pair, shielded  
Cable Ø: 6.3 mm (0.25 in.)  
Cross section: 3 × 2 × 0.14 mm<sup>2</sup>  
Bending radius: 7 × D (fixed installation)  
Operating temperature: -50...+150 °C (-58...+302 °F)



**Cable with M12 A-coded female connector (8 pin), straight – pigtail**  
Part no. 370 674

Material: PUR jacket; black  
Feature: Shielded  
Cable length: 5 m (16.4 ft)  
Ingress protection: IP67/IP69K (correctly fitted)  
Operating temperature: -25...+80 °C (-13...+176 °F)



**Cable with M12 A-coded female connector (8 pin), angled – pigtail**  
Part no. 370 676

Cable: Shielded  
Cable length: 5 m (16.4 ft)  
Ingress protection: IP67 (correctly fitted)

**Programming tools**



**TempoLink® kit for Temposonics® R-Series V**  
Part no. TL-1-0-SD70 (for D70)  
Part no. TL-1-0-SD84 (for D84)  
Part no. TL-1-0-AS00 (for cable outlet)

- Connect wirelessly via Wi-Fi enabled device or via USB with the diagnostic tool
- Simple connectivity to the sensor via 24 VDC power line (permissible cable length: 30 m)
- User friendly interface for mobile devices and desktop computers
- See data sheet "TempoLink® smart assistant" (document part no.: [552070](#)) for further information



**TempoGate® smart assistant for Temposonics® R-Series V**  
Part no. TG-C-0-Dxx  
(xx indicates the number of R-Series V sensors that can be connected (even numbers only))

- OPC UA server for diagnostics of the R-Series V
- For installation in the control cabinet
- Connection via LAN and Wi-Fi
- See data sheet "TempoGate® smart assistant" document part no.: [552110](#) for further information

Color of connectors and cable jacket may change. Color codes for the individual wires and technical properties remain unchanged.

## ORDER CODE

1	2	3	4	5	6	7	8	9	10	11	12	13	14	15	16	17	18	19	20	21	22	23	24	25	26	27		
R	H	5													1	S												
a			b		c		d				e		f			g	h	i	j	k	l	m	n	o				

optional

a	Sensor model
R H 5	Rod

b	Design
B	Base unit (only for replacement)
J	Threaded flange M22×1.5-6g (rod Ø 12.7 mm), stroke length: 25...5900 mm (1...232 in.)
M	Threaded flange M18×1.5-6g (standard)
S	Threaded flange ¾"-16 UNF-3A (standard)
T	Threaded flange ¾"-16 UNF-3A (with raised-face)

c	Mechanical options
A	Standard
B	Bushing on rod end (only for design »M«, »S« & »T«)
F	Flexible sensing element (only for design »B«, »M«, »S« & »T«)
M	Thread M4 at rod end (only for design »M«, »S« & »T«)
V	Fluorelastomer seals for the sensor electronics housing

d	Stroke length
X X X X M	0025...7620 mm
Standard stroke length (mm)      Ordering steps	
25... 500 mm	5 mm
500... 750 mm	10 mm
750...1000 mm	25 mm
1000...2500 mm	50 mm
2500...5000 mm	100 mm
5000...7620 mm	250 mm
X X X X U	001.0...300.0 in.
Standard stroke length (in.)      Ordering steps	
1... 20 in.	0.2 in.
20... 30 in.	0.4 in.
30... 40 in.	1.0 in.
40...100 in.	2.0 in.
100...200 in.	4.0 in.
200...300 in.	10.0 in.
Non-standard stroke lengths are available; must be encoded in 5 mm/0.1 in. increments.	

e	Number of magnets
X X	01...02 position(s) (1...2 magnet(s))

f	Connection type
Connector	
D 7 0	M16 male connector (7 pin)
D 8 4	M12 male connector (8 pin)
Angled cable outlet	
B X X	XX m/ft. PUR cable (part no. 530 175) B01...B30 (1...30 m/3...99 ft.) (Note the temperature range of the cable!) See "Frequently ordered accessories" for cable specifications
E X X	XX m/ft. PVC cable (part no. 530 032) E01...E30 (1...30 m/3...99 ft.) See "Frequently ordered accessories" for cable specifications
G X X	XX m/ft. FEP cable (part no. 530 157) G01...G30 (1...30 m/3...99 ft.) See "Frequently ordered accessories" for cable specifications
L X X	XX m/ft. PUR cable (part no. 530 052) L01...L30 (1...30 m/3...99 ft.) (Note the temperature range of the cable!) See "Frequently ordered accessories" for cable specifications
U X X	XX m/ft. Silicone cable (part no. 530 176) U01...U30 (1...30 m/3...99 ft.) See "Frequently ordered accessories" for cable specifications
Straight cable outlet	
H X X	XX m/ft. PUR cable (part no. 530 052) H01...H30 (1...30 m/3...99 ft.) (Note the temperature range of the cable!) See "Frequently ordered accessories" for cable specifications
P X X	XX m/ft. PUR cable (part no. 530 175) P01...P30 (1...30 m/3...99 ft.) (Note the temperature range of the cable!) See "Frequently ordered accessories" for cable specifications
R X X	XX m/ft. PVC cable (part no. 530 032) R01...R30 (1...30 m/3...99 ft.) See "Frequently ordered accessories" for cable specifications
T X X	XX m/ft. FEP cable (part no. 530 112) T01...T30 (1...30 m/3...99 ft.) See "Frequently ordered accessories" for cable specifications
Encode in meters if using metric stroke length. Encode in feet if using US customary stroke length.	

g System	
1	Standard

h Output	
S	SSI

i Function	
1	Position
2	Differential measurement (2 magnets and 1 output)
3	Velocity
4	Position and temperature in the sensor electronics housing; <b>NOTICE</b> In this case, only option 2 “24 bit” can be selected under 1 “Data length”.

j Options	
0	Standard
1	Internal linearization

k Mode	
1	Measuring direction forward, asynchronous mode
2	Measuring direction forward, synchronous mode 1
3	Measuring direction forward, synchronous mode 2
4	Measuring direction forward, synchronous mode 3
5	Measuring direction reverse, asynchronous mode
6	Measuring direction reverse, synchronous mode 1
7	Measuring direction reverse, synchronous mode 2
8	Measuring direction reverse, synchronous mode 3

l Data length*	
1	25 bit
2	24 bit
3	26 bit
A	24 bit + alarm bit + parity bit

m Format	
B	Binary
G	Gray

n Resolution	
1	5 µm
2	10 µm
3	50 µm
4	100 µm
5	20 µm
6	2 µm
7	0.1 µm*
8	1 µm
9	0.5 µm

o Additional options (optional)				
S	0	0	2	FIR filter (2 measurements)
S	0	0	4	FIR filter (4 measurements)
S	0	0	8	FIR filter (8 measurements)
S	0	0	A	No filter, error counter (4 cycles)
S	0	0	C	No filter, error counter (8 cycles)
S	0	0	D	No filter, error counter (10 cycles)
S	0	0	G	FIR filter (8 measurements), error counter (10 cycles)
S	0	0	J	IIR filter (filter grade 4)
S	0	0	K	IIR filter (filter grade 8)
S	0	0	N	IIR filter (filter grade 8), error counter (10 cycles)

#### NOTICE

- Specify the number of magnets for your application and order the magnets separately.
- The number of magnets is limited by the stroke length. The minimum allowed distance between magnets (i.e. front face of one to the front face of the next one) is 75 mm (3 in.).
- Use magnets of the same type for differential measurement.
- If the option for internal linearization in j “Options” is chosen, select a suitable magnet.
- The internal linearization 1 in j “Options” is not available with the flexible sensing element F in c “Mechanical options”.

#### DELIVERY



##### RH5-B:

- Base unit (without flange & rod assembly)
- 3 × socket screws M4×59

##### RH5-J/-M/-S/-T:

- Sensor
- O-ring

Accessories have to be ordered separately.

\* / The stroke length of the sensor influences the choice of resolution and data length. See glossary under “Resolution and data length depending on stroke length”

Manuals, Software & 3D Models available at:  
[www.temposonics.com](http://www.temposonics.com)

## GLOSSARY

### A

#### Alarm

The alarm bit is set by the sensor if the sensor detects more magnets (extra magnet) or less magnets (magnet status error) than configured.

#### Asynchronous mode

In asynchronous mode the position data is continuously updated inside the sensor as quickly as the sensor's measurement cycle will allow, independent of the controller. The controller's loop time will determine when the sensor's most recent data is clocked out over the SSI interface. (→ Synchronous mode)

### D

#### Differential measurement

For differential measurement, the distance between the two position magnets is output as a value.

### E

#### Extrapolation

The native measurement cycle time of a sensor increases with the stroke length. With extrapolation, the sensor is able to report data faster than the native cycle time, independent of the stroke length of the sensor. Without extrapolation, if data is requested faster than the native cycle time, the last measured value is repeated.

### F

#### FIR filter

The FIR filter (Finite Impulse Response) is used to smooth the measured position value before output. To determine the output value, only input values corresponding to the window (filter window size) are used for filter calculation. The output value is calculated from these input values in the form of a moving average value. (→ IIR Filter)

### I

#### IIR filter

The IIR filter (Infinite Impulse Response) is used to smooth the measured position value before output. To determine the output value, the input values corresponding to the filter grade (filter window size) are used for the filter calculation. The previous values are also taken into account when calculating the output value. (→ FIR Filter)

#### Internal linearization

The internal linearization offers an improved linearity for an overall higher accuracy of the position measurement. The internal linearization is set for the sensor during production.

### M

#### Measuring direction

When moving the position magnet, the position and velocity values increase in the measuring direction.

- Forward: Values increasing from sensor electronics housing to rod end/profile end
- Reverse: Values decreasing from sensor electronics housing to rod end/profile end

### P

#### Parity

The parity bit is a check bit that is added to a bit string to detect transmission errors. There are even parity and odd parity. With even parity, the parity bit is set so that the total number of 1-bits in the bit string including the parity bit is even. In case of odd parity, the total number of 1-bits in the bit sequence including the parity bit is odd. Even parity is implemented in the R-Series V SSI.

### R

#### Resolution and data length depending on stroke length

The stroke length of the sensor influences the choice of resolution and data length. The resolution (step size) and data length (number of steps) must be selected so that the stroke length is covered. For example, with a data length of 24 bit and a resolution of 0.5 µm for an RH5 sensor the maximum stroke length of 7620 mm can be represented. You can adjust the resolution and the data length of the R-Series V SSI via the TempoLink® and TempoGate® smart assistants.

### S

#### Synchronous Serial Interface

SSI (Synchronous Serial Interface) is a digital interface where the data is transferred serially. The interface of R-Series V SSI corresponds to SSI industry standard for absolute encoders. Its displacement value is encoded in a 24/25/26 bit binary or gray format and transmitted as a differential signal in SSI standard (RS-485/RS-422).

#### Synchronous mode

In synchronous mode the measurement and output of the sensor is matched to the data request cycle of the controller. The synchronous mode minimizes the time delay between measurement and output. The synchronous mode is required for sophisticated motion control applications. (→ Asynchronous mode)

##### • Synchronous mode 1

Using synchronous mode 1, the sensor determines the controller's loop timing and when data is being requested. The sensor then determines when to start the next measurement cycle so that it will complete just in time to deliver the freshest data possible.

##### • Synchronous mode 2

If new position data is required faster than the sensor's measurement cycle time, synchronous mode 2 provides extrapolated data values, calculated on the fly. A measurement value will be calculated and output to the controller whenever the sensor has not yet completed the next measurement cycle.

##### • Synchronous mode 3

Synchronous mode 3 provides an extrapolation to the high speed update feature of synchronous mode 2. For this mode all measurements values which are output are calculated to fully compensate for the inherent lag time due to the sensor's measurement cycle. (→ Extrapolation)

### T

#### Temperature in the sensor electronics housing

The temperature in the sensor electronics housing is measured in °C. With this option, the transmitted data word has a length of 32 bits, with the highest 8 bits representing the temperature value, followed by 24 bits for the position value. The temperature value is coded in the same format as the position value.

**UNITED STATES**  
**Temposonics, LLC**  
Americas & APAC Region  
3001 Sheldon Drive  
Cary, N.C. 27513  
Phone: +1 919 677-0100  
E-mail: [info.us@temposonics.com](mailto:info.us@temposonics.com)

**GERMANY**  
**Temposonics**  
**GmbH & Co. KG**  
EMEA Region & India  
Auf dem Schüffel 9  
58513 Lüdenscheid  
Phone: +49 2351 9587-0  
E-mail: [info.de@temposonics.com](mailto:info.de@temposonics.com)

**ITALY**  
Branch Office  
Phone: +39 030 988 3819  
E-mail: [info.it@temposonics.com](mailto:info.it@temposonics.com)

**FRANCE**  
Branch Office  
Phone: +33 6 14 060 728  
E-mail: [info.fr@temposonics.com](mailto:info.fr@temposonics.com)

**UK**  
Branch Office  
Phone: +44 79 21 83 05 86  
E-mail: [info.uk@temposonics.com](mailto:info.uk@temposonics.com)

**SCANDINAVIA**  
Branch Office  
Phone: +46 70 29 91 281  
E-mail: [info.sca@temposonics.com](mailto:info.sca@temposonics.com)

**CHINA**  
Branch Office  
Phone: +86 21 3405 7850  
E-mail: [info.cn@temposonics.com](mailto:info.cn@temposonics.com)

**JAPAN**  
Branch Office  
Phone: +81 3 6416 1063  
E-mail: [info.jp@temposonics.com](mailto:info.jp@temposonics.com)

**Document Part Number:**  
552001 Revision E (EN) 12/2024



**temposonics.com**