

Data Sheet

MH-Series MH Threaded Analog

Magnetostrictive Linear Position Sensors

- Stroke length up to 2500 mm
- With M18×1.5 thread
- Sensor rod with Ø 7 mm or Ø 10 mm
- Rugged to withstand off-highway shock and vibration
- M12 connector or cable output

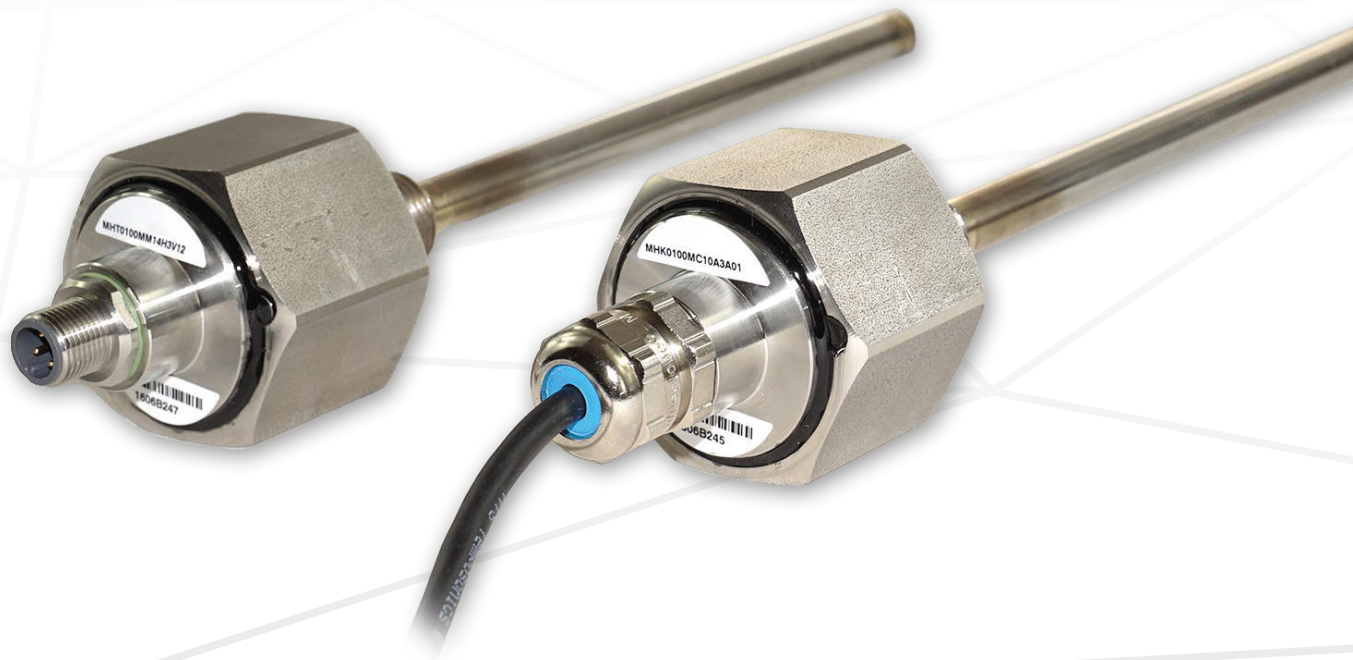

MEASURING TECHNOLOGY

The absolute, linear position sensors provided by Temposonics rely on the company's proprietary magnetostrictive technology, which can determine position with a high level of precision and robustness. Each Temposonics position sensor consists of a ferromagnetic waveguide, a position magnet, a strain pulse converter and supporting electronics. The magnet, connected to the object in motion in the application, generates a magnetic field at its location on the waveguide. A short current pulse is applied to the waveguide. This creates a momentary radial magnetic field and torsional strain on the waveguide. The momentary interaction of the magnetic fields releases a torsional strain pulse that propagates the length of the waveguide. When the ultrasonic wave reaches the end of the waveguide it is converted into an electrical signal. Since the speed of the ultrasonic wave in the waveguide is precisely known, the time required to receive the return signal can be converted into a linear position measurement with both high accuracy and repeatability.

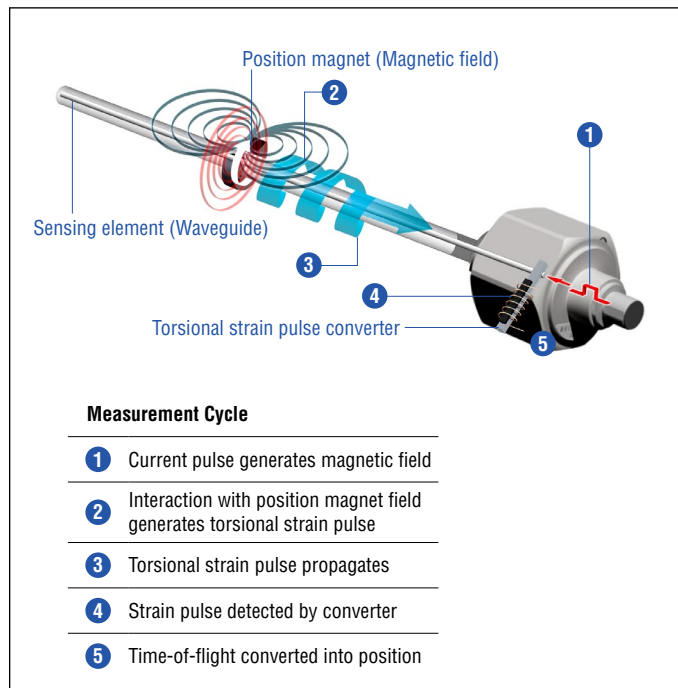

Fig. 1: Time-of-flight based magnetostrictive position sensing principle

MH THREADED SENSOR

The Temposonics® MH-Series sensors are specifically designed for direct stroke measurement in hydraulic cylinders. The MH Threaded sensor extends the rugged design of the Temposonics® MH Series sensors to external threaded installations. An M12 connector system ensures protection to IP69K. The inherent absolute capabilities ensure that the MH Threaded sensor is always ready. With two connections styles, the responsive magnetostrictive linear position sensors can be integrated into most installations.

Temposonics® MH Threaded sensors can be used in applications where access is available from the outside of the cylinder. Example applications include lift and tilt cylinders, hydraulic jacks, and hydraulic steering systems in agricultural and construction machinery.



Fig. 2: Typical application: Agricultural sprayer

TECHNICAL DATA

Output		
Current	4...20 mA	
Voltage	0.25...4.75 VDC; 0.5...4.5 VDC	
Measured value	Position	
Signal characteristic	Analog output restricted by noise and ADC	
Measurement parameters		
Resolution	Typ. 0.1 mm	
Internal sample rate	2 ms	
Linearity	0050...0250 mm $\leq \pm 0.1$ mm 0255...2000 mm ± 0.04 % (F.S.) 2005...2500 mm $\leq \pm 0.8$ mm	
Hysteresis	± 0.1 mm	
Setpoint tolerance	< 1 mm	
Operating conditions		
Mounting position	Any	
Operating temperature	-40...+85 °C	
Storage temperature	-25...+65 °C	
Humidity	EN60068-2-30, 90 % rel. humidity, no condensation	
Ingress protection – M12 connector	IP69K with M12 connector and mating plug	
Ingress protection – Cable output	IP69K	
Shock test	IEC 60068-2-27, 100 g (6 ms) single shock, 50 g (11 ms) at 1000 shocks per axis	
Vibration test	Vibrations: IEC 60068-2-64, 15 g (r.m.s.) \varnothing 7 mm rod (10...2000 Hz) - resonance frequencies excluded 20 g (r.m.s.) \varnothing 10 mm rod (10...2000 Hz) - resonance frequencies excluded	
EMC test	2009/64/EG Road vehicles 2009/19/EG Agricultural and Forest machines ISO 14982 Emissions/Immunity ISO 7637-1/2 Transient Impulses ISO / TR 10605 Electrostatic Discharge (E.S.D.)	
Pressure impulse test according DIN EN ISO 19879	\varnothing 7 mm rod	\varnothing 10 mm rod
Operation pressure (P_N)	300 bar	350 bar
Operation pressure (P_{max})	400 bar	450 bar
Operation pressure (P_{static})	525 bar	625 bar
Design/Material		
Sensor electronics housing	Stainless steel 1.4305 (AISI 303)	
Sensor rod	\varnothing 7 mm: Stainless steel 1.4301 (AISI 304) / \varnothing 10 mm: Stainless steel 1.4306 (AISI 304L)	
Stroke length	50...2500 mm	
Sealing	O-ring 15.4 x 2.1, NBR 90 black	
Electrical connection		
Connection type	M12 connector or cable output	
Operating voltage	+12/24 VDC (8...32 VDC)	
Current consumption	12 VDC: typ. < 100 mA; 24 VDC: typ. < 50 mA	
Load (output VDC)	$R_L \geq 10$ k Ω	
Load (output mA)	12 VDC: $R_L \leq 250$ Ω ; 24 VDC: $R_L \leq 500$ Ω	
Inrush current	12 VDC: max. 2.5 A/2 ms; 24 VDC: max. 4.5 A/2 ms	
Supply voltage ripple	< 1 % _{PP}	
Power drain	< 1 W	
Over voltage protection (VDC-GND)	Up to +36 VDC	
Polarity protection (GND-VDC)	Up to -36 VDC	
Electric strength	500 VDC (DC GND to chassis GND)	

TECHNICAL DRAWING

Form Factor G

Ø 10 mm rod & M8 end plug (male)

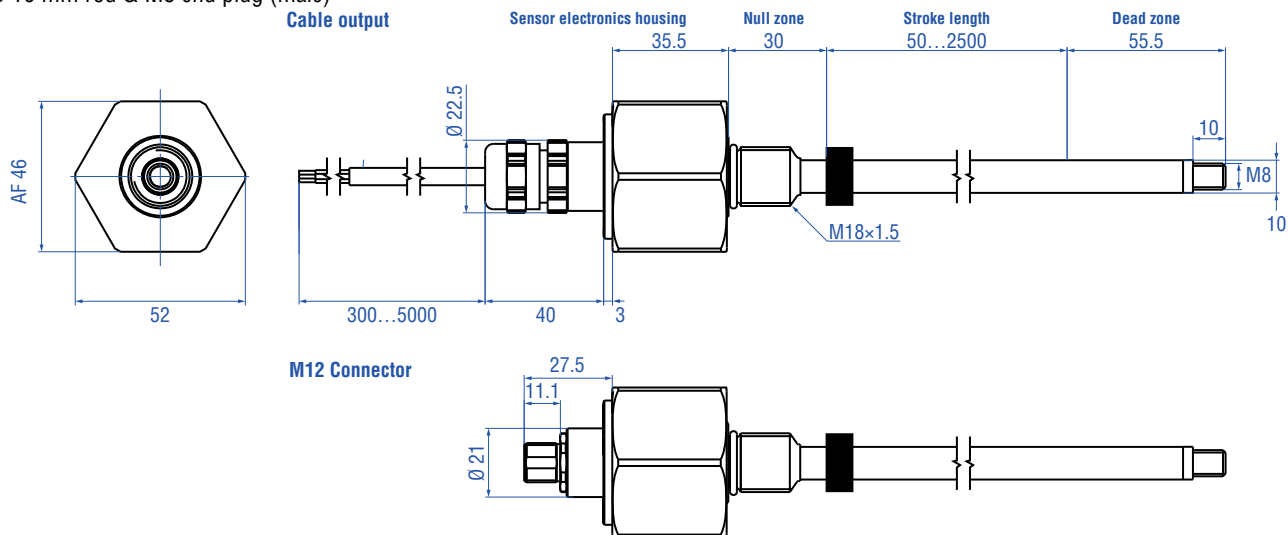

Form Factor K

Ø 10 mm rod & M6 end plug (female)

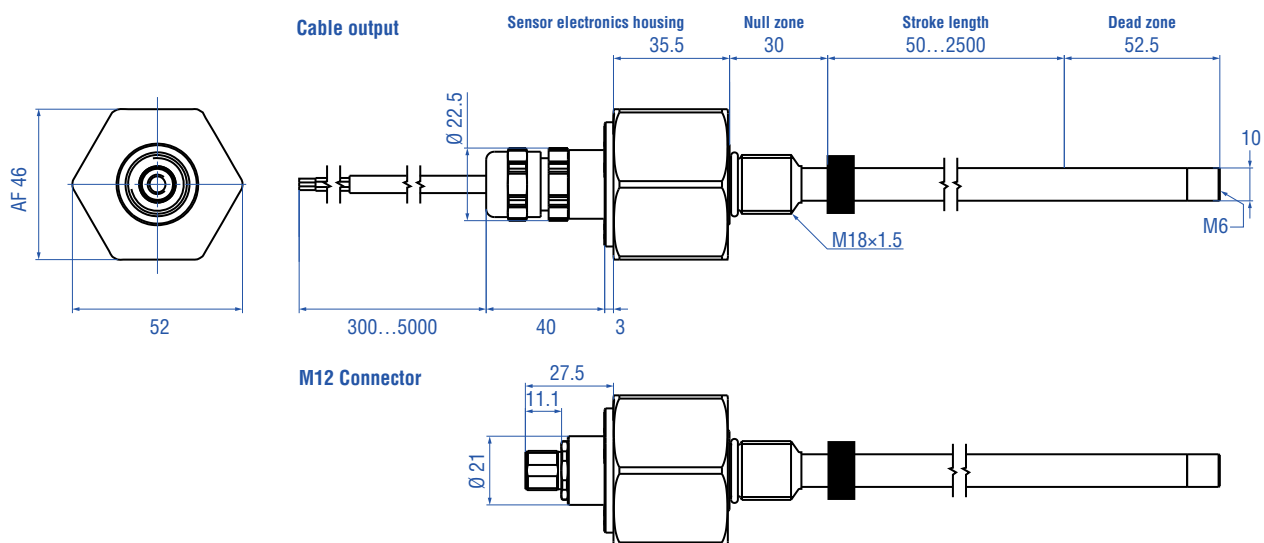

Controlling design dimensions are in millimeters

Unless otherwise stated, apply to the general tolerances according to DIN ISO 2768-m

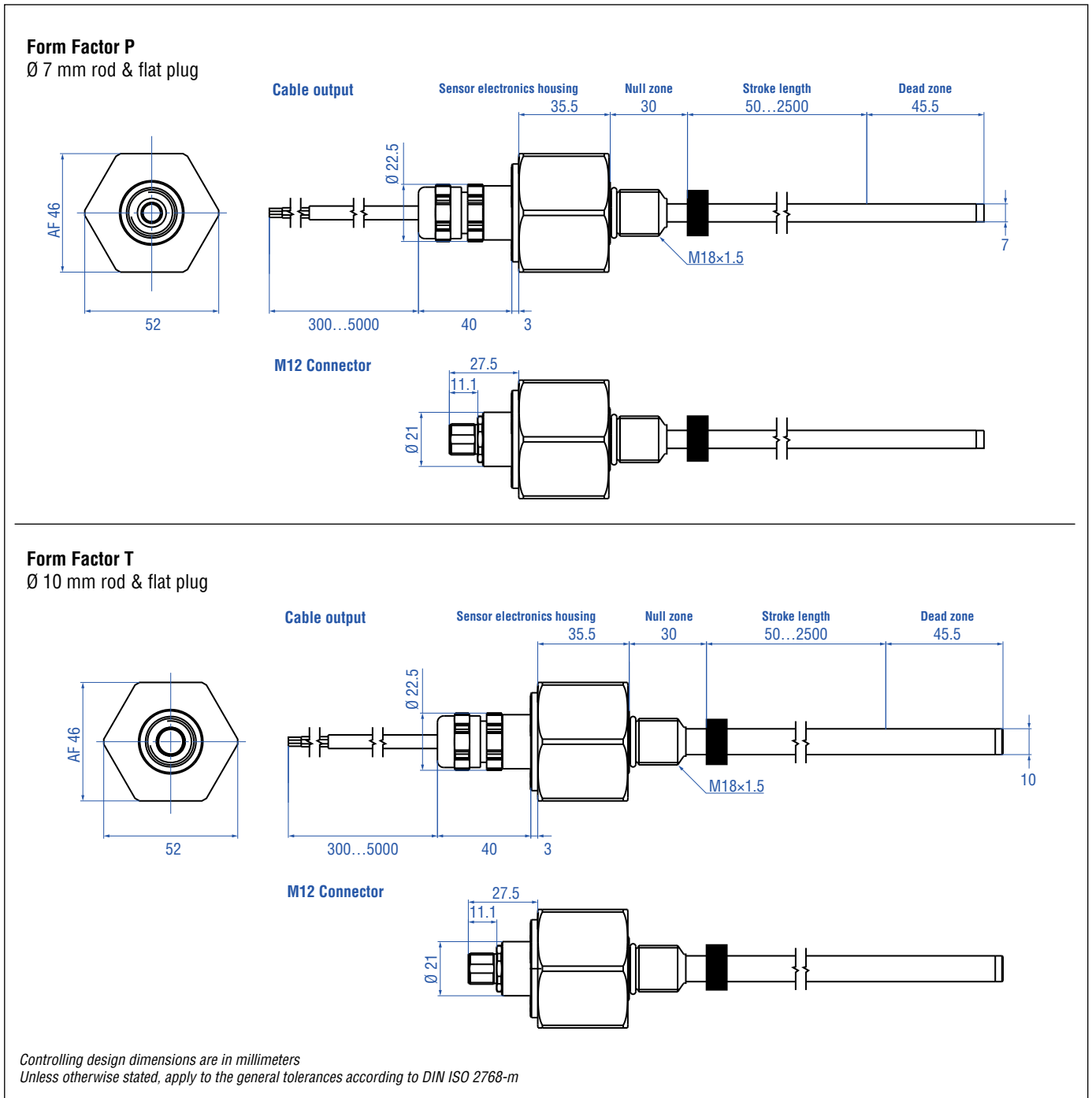

TECHNICAL DRAWING



CONNECTOR WIRING

M12 connector				Cable output		
	Pin	E	G	H	Color	
1	not connected	VDC	VDC		BN	VDC
2	VDC	not connected	SIG		WH	GND
3	GND	GND	GND		GN	SIG
4	SIG	SIG	not connected		-	-

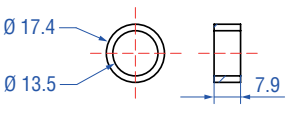
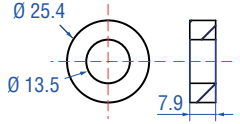
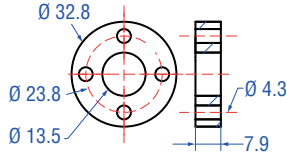
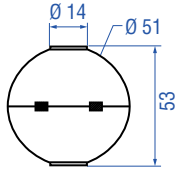
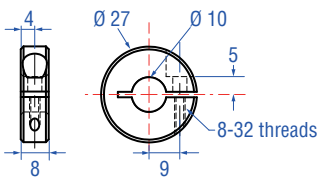
FREQUENTLY ORDERED ACCESSORIES

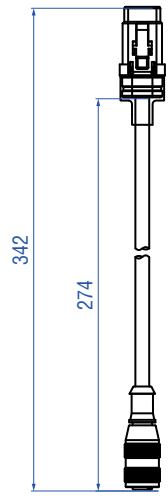
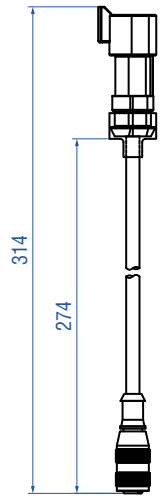
Position magnets		Float	
			
Ring magnet Part no. 401 032	Ring magnet Part no. 400 533	Ring magnet Part no. 201 542-2	Float Part no. 561 612
Material: PA neobind Weight: Ca. 5 g Operating temperature: -40...+100 °C Surface pressure: Max. 20 N/mm ²	Material: PA ferrite Weight: Ca. 10 g Operating temperature: -40...+100 °C Surface pressure: Max. 40 N/mm ²	Material: PA ferrite GF20 Weight: Ca. 14 g Operating temperature: -40...+100 °C Surface pressure: Max. 40 N/mm ² Fastening torque for M4 screws: 1 Nm	Material: Stainless steel AISI 304 Density: 720 kg/m ³ Specific gravity: 0.61 maximum Max. pressure: 40 bar Weight: Ca. 42 g Operation temperature: -40...+125 °C For sensors with Ø 10 mm rod For sensors with up to 2000 mm stroke length
Collar	Test kit	Cord sets and adapter cables	
			
Collar Part no. 560 777	MH test kit (analog) Part no. 280 618	4 pin M12 to DTM06 connector Part no. 254 597	4 pin M12 to DT04 connector Part no. 254 600
Material: Stainless steel 1.4301 (AISI 304) Weight: Ca. 30 g Hex key 7/64" required For sensors with Ø 10 mm rod	Kit includes: <ul style="list-style-type: none"> • 12 VDC battery charger with adapter (EU & UK) • Cable with M12 connector • Cable with pigtailed wires • Carrying case 	M12 connector: Brass/Nickel DT connector: DTM06 3 pin Material: PVC Jacket Cable length: 275 mm Cable Ø: 5 mm Operating temperature: -40...+105 °C	M12 connector: Brass/Nickel DT connector: DT04 3 pin Material: PVC Jacket Cable length: 275 mm Cable Ø: 5 mm Operating temperature: -40...+105 °C

INSTALLATION

Hydraulics sealing

For sealing the flange contact surface, a sealing via an O-ring 15.3 x 2.2 mm in the undercut is necessary. A screw hole based on ISO 6149-1 must be provided.

Screw hole based on ISO 6149-1

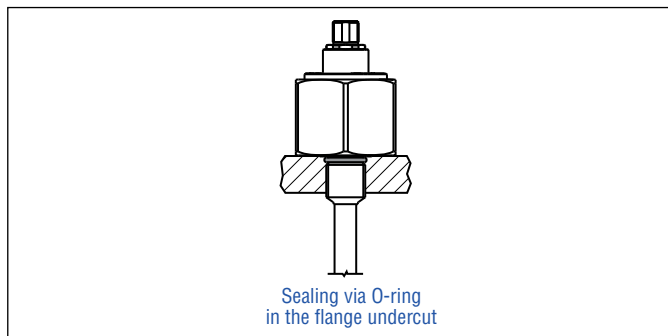
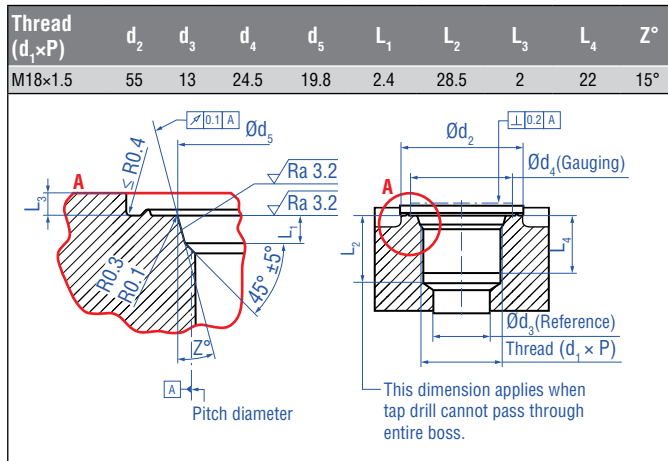

- Note the fastening torque of 50 Nm.
- The flange contact surface must be seated completely on the cylinder mounting surface.
- The cylinder manufacturer determines the pressure-resistant gasket (copper gasket, O-ring, etc.).
- The position magnet should not make contact with the sensor rod.
- The peak pressure should not be exceeded.
- Protect the sensor rod against wear.

For In-Cylinder installation:

- The plunger borehole:
 - Ø 7 mm rod: ≥ Ø 10 mm
 - Ø 10 mm rod: ≥ Ø 13 mm
 depends on the pressure and piston speed.
- The bore depth in piston:
 - Null zone + Stroke length + Dead zone + > 3 mm

Magnet installation for In-Cylinder applications

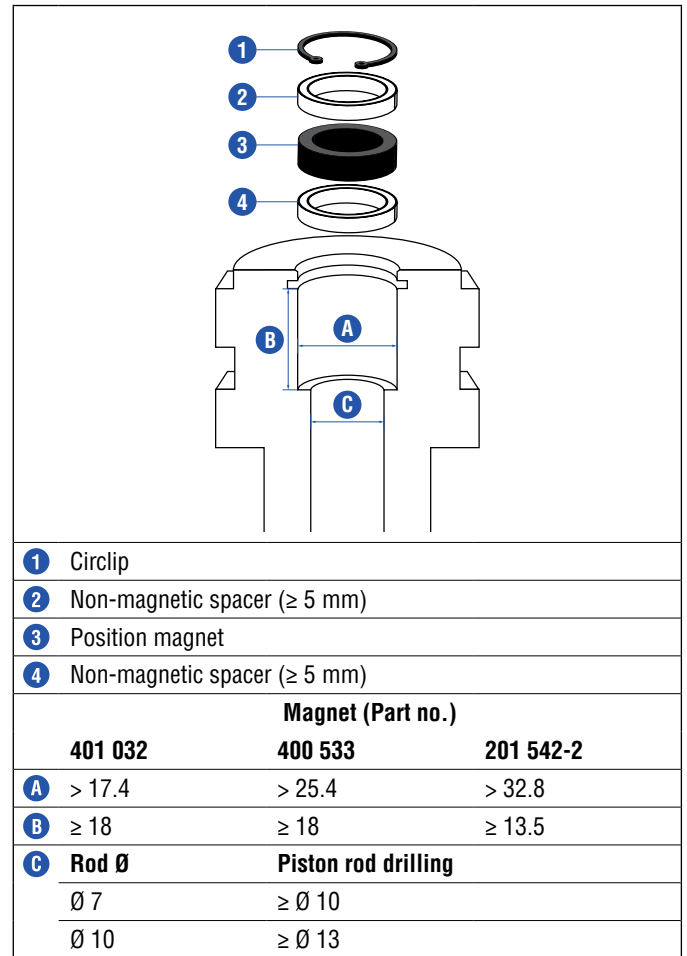

Magnet installation for float applications

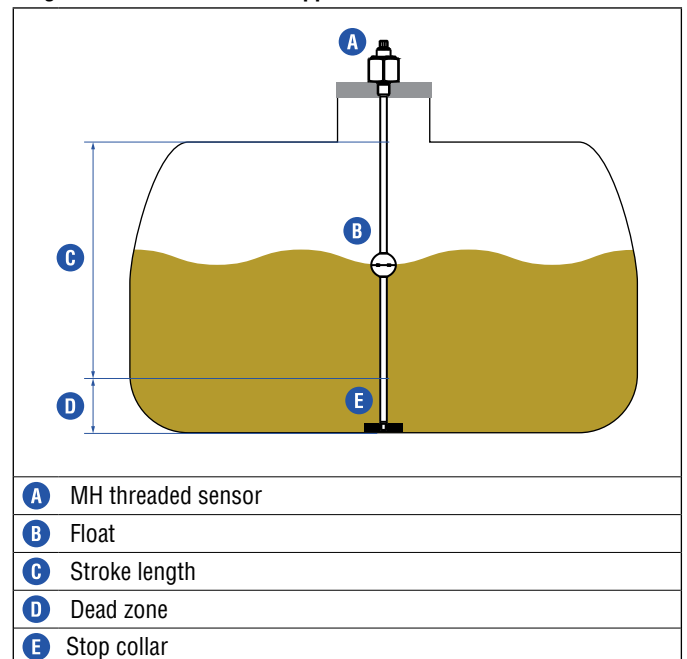

Tempsonics® MH Threaded Analog

Data Sheet

ORDER CODE

1	2	3	4	5	6	7	8	9	10	11	12	13	14	15	16
M	H						M					3			
a		b	c					d				e	f		

a Sensor model

M	H	Rod
---	---	-----

b Form factor

G	Threaded port M18×1.5, rod Ø 10 mm, M8 plug (male)
K	Threaded port M18×1.5, rod Ø 10 mm, M6 plug (female)
P	Threaded port M18×1.5, rod Ø 7 mm, flat plug
T	Threaded port M18×1.5, rod Ø 10 mm, flat plug

c Stroke range (mm)

				0050...2500 mm (in 5 mm steps)
--	--	--	--	--------------------------------

d Electrical wiring

M12 connector (VDC - GND - SIG)

M	0	0	E	4 pin (2-3-4)
M	0	0	G	4 pin (1-3-4)
M	0	0	H	4 pin (1-3-2)

Cable output

C	0	3	A	300 mm pigtailed wire termination
C	0	5	A	500 mm pigtailed wire termination
C	1	0	A	1000 mm pigtailed wire termination
C	2	0	A	2000 mm pigtailed wire termination
C	3	0	A	3000 mm pigtailed wire termination
C	5	0	A	5000 mm pigtailed wire termination

e Supply voltage

3	+12/24 VDC (8...32 VDC)
---	-------------------------

f Output

V	1	1	0.25...4.75 VDC
V	1	2	0.5...4.5 VDC
V	1	3	4.75...0.25 VDC
V	1	4	4.5...0.5 VDC
A	0	1	4...20 mA
A	0	4	20...4 mA

DELIVERY



Position sensor,
O-ring

Accessories have to be ordered
separately.

Operation manuals & software are available at:
www.temposonics.com

UNITED STATES
Temposonics, LLC
Americas & APAC Region
3001 Sheldon Drive
Cary, N.C. 27513
Phone: +1 919 677-0100
E-mail: info.us@temposonics.com

GERMANY
Temposonics
GmbH & Co. KG
EMEA Region & India
Auf dem Schüffel 9
58513 Lüdenscheid
Phone: +49 2351 9587-0
E-mail: info.de@temposonics.com

ITALY
Branch Office
Phone: +39 030 988 3819
E-mail: info.it@temposonics.com

FRANCE
Branch Office
Phone: +33 6 14 060 728
E-mail: info.fr@temposonics.com

UK
Branch Office
Phone: +44 79 21 83 05 86
E-mail: info.uk@temposonics.com

SCANDINAVIA
Branch Office
Phone: + 46 70 29 91 281
E-mail: info.sca@temposonics.com

CHINA
Branch Office
Phone: +86 21 2415 1000 / 2415 1001
E-mail: info.cn@temposonics.com

JAPAN
Branch Office
Phone: +81 3 6416 1063
E-mail: info.jp@temposonics.com

Document Part Number:
551827 Revision A (EN) 01/2017

**UK
CA**

ISO 9001
CERTIFIED



temposonics.com