

Operation Manual

E-Series – ET Analog Magnetostrictive Linear Position Sensors



■ ATEX/UK Ex/IECEX/CEC/NEC/CCC certified



Table of contents

| | |
|--|-----------|
| 1. Introduction | 3 |
| 1.1 Purpose and use of this manual | 3 |
| 1.2 Used symbols and warnings | 3 |
| 2. Safety instructions | 3 |
| 2.1 Intended use | 3 |
| 2.2 Forseeable misuse | 3 |
| 2.3 Installation, commissioning and operation | 4 |
| 2.4 Safety instructions for use in explosion-hazardous areas | 5 |
| 2.5 Warranty | 5 |
| 2.6 Return | 5 |
| 3. Identification | 6 |
| 3.1 Order code Temposonics® ET | 6 |
| 3.2 Nameplate (example) | 7 |
| 3.3 Approvals | 7 |
| 3.4 Scope of delivery | 7 |
| 4. Product description and commissioning | 7 |
| 4.1 Functionality and system design | 7 |
| 4.2 Installation and design of Temposonics® ET (rod style) | 8 |
| 4.3 Installation and design of Temposonics® ET (profile style) | 10 |
| 4.4 Magnet installation | 11 |
| 4.5 Electrical connection | 12 |
| 4.6 Frequently ordered accessories for ET-F/-W/-M/-S | 14 |
| 4.7 Frequently ordered accessories for ET-P | 15 |
| 4.8 Frequently ordered accessories for Analog output | 16 |
| 5. Operation | 17 |
| 5.1 Getting started | 17 |
| 5.2 Programming and configuration | 17 |
| 6. Maintenance and troubleshooting | 24 |
| 6.1 Error conditions, troubleshooting | 24 |
| 6.2 Maintenance | 24 |
| 6.3 Repair | 24 |
| 6.4 List of spare parts | 24 |
| 6.5 Transport and storage | 24 |
| 7. Removal from service/dismantling | 24 |
| 8. Technical data of Temposonics® ET | 25 |
| 9. Appendix | 27 |
| 10. Declaration of conformity | 28 |

1. Introduction

1.1 Purpose and use of this manual

Before starting the operation of Temposonics position sensors, read this documentation thoroughly and follow the safety information. Keep this manual for future reference!

The content of this technical documentation and of its appendix is intended to provide information on mounting, installation and commissioning by qualified automation personnel ¹ or instructed service technicians who are familiar with the project planning and dealing with Temposonics sensors.

1.2 Used symbols and warnings

Warnings are intended for your personal safety and for avoidance of damage to the described product or connected devices. In this documentation, safety information and warnings to avoid danger that might affect the life and health of operating as well as service personnel or cause material damage are highlighted by the preceding pictogram, which is defined below.

| Symbol | Meaning |
|---------------|--|
| NOTICE | This symbol is used to point to situations that may lead to material damage, but not to personal injury. |

2. Safety instructions

2.1 Intended use

This product may be used only for the applications defined under item 1 to item 4 and only in conjunction with the third-party devices and components recommended or approved by Temposonics. As a prerequisite of proper and safe operation, the product requires correct transport, storage, mounting and commissioning and must be operated with utmost care.

1. The sensor systems of all Temposonics® series are intended exclusively for measurement tasks encountered in industrial, commercial and laboratory applications. The sensors are considered as system accessories and must be connected to suitable evaluation electronics, e.g. a PLC, IPC, indicator or other electronic control unit.
2. The sensor's surface temperature class is T4.
3. The ATEX, UK Ex, IECEX, CEC, NEC and CCC certificates have to be taken into account, including any special conditions defined therein, as well as chapter "2.3 Installation, commissioning and operation" on page 4.

^{1/} The term qualified technical personnel characterizes persons who:

- are familiar with the safety concepts of automation technology applicable to the particular project
- are competent in the field of electromagnetic compatibility (EMC)

4. The position sensor may be used in hazardous areas according to Fig. 41. Any use of this product outside of these approved areas will void the warranty and all manufacturer's product responsibilities and liabilities. For non-hazardous areas Temposonics recommends to use the version N (not approved).

| Zone | Explosion group |
|--|---------------------|
| Zone 2 (Gas-Ex, category 3G, EPL Gc) | IIA, IIB and IIC |
| Zone 22 (Dust-Ex, category 3D, EPL Dc) | IIIA, IIIB and IIIC |

| Class | Group |
|---------------------------------|------------|
| Class I (Gas, Division 2) | A, B, C, D |
| Class II/III (Dust, Division 2) | F, G |

2.2 Forseeable misuse

| Forseeable misuse | Consequence |
|---|--|
| Lead compensating currents through the enclosure | The sensor will be damaged |
| Wrong sensor connection | The sensor will not work properly or will be destroyed |
| Operate the sensor out of the operating temperature range | No signal output – The sensor can be damaged |
| Power supply is out of the defined range | Signal output is wrong / no signal output/ the sensor will be damaged |
| Position measurement is influenced by an external magnetic field | Signal output is wrong |
| Cables are damaged | Short circuit – the sensor can be destroyed/sensor does not respond |
| Spacers are missing/ are installed in a wrong order | Error in position measurement |
| Wrong connection of ground/shield | Signal output is disturbed – The electronics can be damaged |
| Use of a magnet that is not certified by Temposonics | Error in position measurement |
| Output 2 is connected to ground with low-impedance, output 1 is connected with high-impedance | The sensor is in programming mode – The sensor delivers faulty position values |

- have received adequate training for commissioning and service operations
- are familiar with the operation of the device and know the information required for correct operation provided in the product documentation

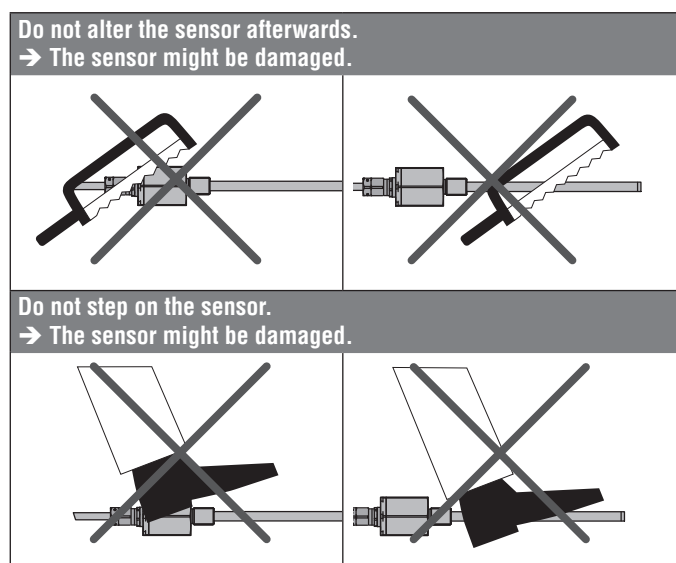

2.3 Installation, commissioning and operation

The position sensors must be used only in technically safe condition. To maintain this condition and to ensure safe operation, installation, connection and service, work may be performed only by qualified technical personnel, according to IEC 60079-14, IEC 60079-17, TRBS 1203, Canadian Electrical Code (CEC), National Electrical Code (NEC), China Compulsory Certification (CCC) and local regulations. If danger of injury to persons or of damage to operating equipment is caused by sensor failure or malfunction, additional safety measures such as plausibility checks, limit switches, EMERGENCY STOP systems, protective devices etc. are required. In the event of trouble, shut down the sensor and protect it against accidental operation.

Safety instructions for commissioning

To maintain the sensor's operability, it is mandatory to follow the instructions given below.

1. Follow the specifications given in the technical data.
2. Ensure that equipment and associated components used in a hazardous environment are selected and installed in compliance with regulations governing the geographical location and facility. Only install equipment that complies with the types of protection relevant to the applicable Zones and Categories.
3. In explosive atmospheres use only such auxiliary components that meet all requirements of the local and national standards.
4. The potential equalisation of the system has to be established according to the regulations of erection applicable in the respective country of use (VDE 0100, part 540; IEC 364-5-54).
5. Sensors from Temposonics are approved only for the intended use in industrial environments (see chapter "2.1 Intended use" on page 3). Contact the manufacturer for advice, if aggressive substances are present in the sensor environment.
6. Measures for lightning protection have to be taken by the user.
7. The user is responsible for the mechanical protection of the sensor.

8. The cable gland of the sensor must be protected against any external impact energy exceeding 4 joule. The maximum thermal load of the cables must be taken into account.
9. The user is responsible for meeting all safety conditions as outlined by:
 - Installation instructions
 - Local prevailing standards and regulations
10. Any parts of the equipment which got stuck (e.g. by frost or corrosion) may not be removed by force if potentially explosive atmosphere is present.
11. The formation of ice on the equipment has to be prevented.
12. It is not allowed to open the sensor.
13. The connecting cable has to be either led out of the hazardous area uncut or wired to outlets which comply with the type of protection required locally.
14. The surface temperatures of equipment parts must be kept clearly below the ignition temperature of the foreseeable air/dust mixtures in order to prevent the ignition of suspended dust.

How to ensure safe commissioning

1. Protect the sensor against mechanical damage during installation and operation.
2. Do not use damaged products and secure them against unintentional commissioning. Mark damaged products as being defective.
3. Prevent electrostatic charges.
4. Do not use the sensor in cathodic systems for corrosion protection. Do not led parasitic currents via the construction.
5. Switch off the supply voltage prior to disconnecting or connecting the equipment.
6. Connect the sensor very carefully and pay attention to the polarity of connections, power supply as well as where appropriate to the shape and duration of control pulses.
7. Use only approved power supplies.
8. Ensure that the specified permissible limit values of the sensor for supply voltage, environmental conditions, etc. are met.
9. Make sure that:
 - the sensor and associated components were installed according to the instructions
 - the sensor enclosure is clean
 - the magnet does not grind on the rod. This could cause damage to the magnet and the sensor rod. If there is contact between the moving magnet including the magnet holder and the sensor rod, make sure that the maximal speed of the moving magnet is less or equal 1 m/s.
10. Ground the sensor via the ground lug. Both the sensor and the moving magnet including magnet holder must be connected to protective ground (PE) to avoid electrostatic discharge (ESD).
11. Before applying power, ensure that nobody's safety is jeopardized by starting machines.
12. Check the function of the sensor regularly and provide documentation of the checks.
(see chapter "6.2 Maintenance" on page 24).

2.4 Safety instructions for use in explosion-hazardous areas

The sensor has been designed for operation inside explosion-hazardous areas. It has been tested and left the factory in a condition in which it is safe to operate. Relevant regulations and European standards as well as Canadian and North American standards have been observed. According to Ex marking (see chapter “2.1 Intended use” on page 3) and the ATEX and UK Ex certificates (attached to this document), the sensor is approved only for operation in defined hazardous areas. All other certificates can be found at: www.temposonics.com.

2.5 Warranty

Temposonics grants a warranty period for the position sensors and supplied accessories relating to material defects and faults that occur despite correct use in accordance with the intended application². The Temposonics obligation is limited to repair or replacement of any defective part of the unit. No warranty can be provided for defects that are due to improper use or above average stress of the product, as well as for wear parts. Under no circumstances will Temposonics accept liability in the event of offense against the warranty rules, no matter if these have been assured or expected, even in case of fault or negligence of the company. Temposonics explicitly excludes any further warranties. Neither the company’s representatives, agents, dealers nor employees are authorized to increase or change the scope of warranty.

2.6 Return

For diagnostic purposes, the sensor can be returned to Temposonics. Any shipment cost is the responsibility of the sender². For a corresponding form, see chapter “9. Appendix” on page 27.

NOTICE

When returning sensors, place protective caps on male and female connectors of the sensor. For pigtail cables, place the cable ends in a static shielding bag for electrostatic discharge (ESD) protection. Fill the outer packaging around the sensor completely to prevent damage during transport.

2/ See also applicable Temposonics terms of sales and delivery on www.temposonics.com

3. Identification

3.1 Order code Temposonics® ET

| | | | | | | | | | | | | | | | | |
|---|---|---|---|---|---|---|---|---|----|----|----|----|----|----|----|----|
| 1 | 2 | 3 | 4 | 5 | 6 | 7 | 8 | 9 | 10 | 11 | 12 | 13 | 14 | 15 | 16 | 17 |
| E | T | | | | | | | | | | 1 | | | | | |
| a | | b | c | | | | | d | | | e | f | g | | | h |

| | | |
|----------|---------------------|-------------|
| a | Sensor model | |
| E | T | Rod/Profile |

| | |
|--|------------------------------|
| b | Design |
| ET rod-style sensor with housing and sensor rod material stainless steel 1.4404 (AISI 316L) | |
| F | Threaded flange ¾"-16 UNF-3A |
| W | Threaded flange M18×1.5-6g |
| ET rod-style sensor with housing material stainless steel 1.4305 (AISI 303) and sensor rod material stainless steel 1.4306 (AISI 304L) | |
| M | Threaded flange M18×1.5-6g |
| S | Threaded flange ¾"-16 UNF-3A |
| ET profile-style sensor with housing material stainless steel 1.4305 (AISI 303) and profile material aluminum | |
| P | Profile |

| | | | | | |
|---|----------------------|-----------------------|---|---|-------------------|
| c | Stroke length | | | | |
| X | X | X | X | M | 0050...3000 mm |
| Standard stroke length (mm) | | Ordering steps | | | |
| 50... 500 mm | | 5 mm | | | |
| 500... 750 mm | | 10 mm | | | |
| 750...1000 mm | | 25 mm | | | |
| 1000...2500 mm | | 50 mm | | | |
| 2500...3000 mm | | 100 mm | | | |
| X | X | X | X | U | 002.0...118.0 in. |
| Standard stroke length (in.) | | Ordering steps | | | |
| 2... 20 in. | | 0.2 in. | | | |
| 20... 30 in. | | 0.5 in. | | | |
| 30... 40 in. | | 1.0 in. | | | |
| 40...100 in. | | 2.0 in. | | | |
| 100...118 in. | | 4.0 in. | | | |
| Non-standard stroke lengths are available; must be encoded in 5 mm / 0.1 in. increments | | | | | |

| | | | |
|----------|------------------------|---|---|
| d | Connection type | | |
| T | X | X | T01...T10 (1...10 m) XX m FEP cable (part no. 530 112) |
| | | | T03...T33 (3...33 ft.) XX ft. FEP cable (part no. 530 112) |
| V | X | X | V01...V10 (1...10 m) XX m silicone cable (part no. 530 113) |
| | | | V03...V33 (3...33 ft.) XX ft. silicone cable (part no. 530 113) |

Encode in meters if using metric stroke length.
Encode in feet if using US customary stroke length.

| | |
|----------|--------------------------|
| e | Operating voltage |
| 1 | +24 VDC (-15/+20 %) |

| | |
|----------|--|
| f | Version (see "Certification of Temposonics® ET (version A and E)" on page 26 for further information) |
| A | ATEX/UK Ex/IECEX/CEC/NEC/CCC |
| E | ATEX/UK Ex/IECEX/CEC/NEC/CCC with ½" NPT adapter |
| N | Not approved |

NOTICE

Version E (section **f**) is only available with design »M« and »S« (section **b**).

| | | | |
|--|---------------|---|----------------------------|
| g | Output | | |
| Voltage | | | |
| 1 output with 1 position magnet | | | |
| Output 1 (position magnet 1) | | | |
| V | 0 | 1 | 0...10 VDC |
| V | 1 | 1 | 10...0 VDC |
| 2 outputs with 1 position magnet | | | |
| Output 1 (position magnet 1) + output 2 (position magnet 1) | | | |
| V | 0 | 3 | 0...10 VDC 10...0 VDC |
| 2 outputs with 2 position magnets | | | |
| Output 1 (position magnet 1) + output 2 (position magnet 2) | | | |
| V | 0 | 2 | 0...10 VDC 0...10 VDC |
| V | 1 | 2 | 10...0 VDC 10...0 VDC |
| Current | | | |
| 1 output with 1 position magnet | | | |
| Output 1 (position magnet 1) | | | |
| A | 0 | 1 | 4...20 mA |
| A | 1 | 1 | 20...4 mA |
| 2 outputs with 1 position magnet | | | |
| Output 1 (position magnet 1) + output 2 (position magnet 1) | | | |
| A | 0 | 3 | 4...20 mA 20...4 mA |
| 2 outputs with 2 position magnets | | | |
| Output 1 (position magnet 1) + output 2 (position magnet 2) | | | |
| A | 0 | 2 | 4...20 mA 4...20 mA |
| A | 1 | 2 | 20...4 mA 20...4 mA |

| | |
|----------|---|
| h | Operating temperature (optional) |
| L | -40...+75 °C (-40...+167 °C) |

3.2 Nameplate (example)



Fig. 1: Label of sensor for use in explosion hazardous areas

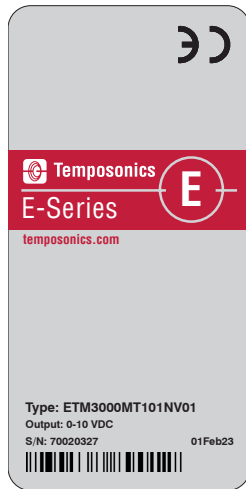

Fig. 2: Label of sensor without certification for use in explosion hazardous areas

3.3 Approvals

See chapter “8. Technical data of Temposonics® ET” on page 25 f.

3.4 Scope of delivery

ET-F/-W/-M/-S (rod sensor):

- Sensor

ET-P (profile sensor):

- Sensor
- 2 mounting clamps up to 1250 mm (50 in.) stroke length + 1 mounting clamp for each 500 mm (20 in.) additional stroke length

4. Product description and commissioning

4.1 Functionality and system design

Product designation

- Position sensor Temposonics® E-Series

Sensor model

- Temposonics® E-Series ET-F/-W/-M/-S (rod sensor)
- Temposonics® E-Series ET-P (profile sensor)

Stroke length

- 50...3000 mm (2...118 in.)

Output signal

- Analog

Application

position sensors are used for measurement and conversion of the length (position) variable in the fields of automated systems and mechanical engineering.

Principle of operation and system construction

The absolute, linear position sensors provided by Temposonics rely on the company's proprietary Temposonics® magnetostrictive technology, which can determine position with a high level of precision and robustness. Each position sensor consists of a ferromagnetic waveguide, a position magnet, a strain pulse converter and supporting electronics. The magnet, connected to the object in motion in the application, generates a magnetic field at its location on the waveguide. A short current pulse is applied to the waveguide. This creates a momentary radial magnetic field and torsional strain on the waveguide. The momentary interaction of the magnetic fields releases a torsional strain pulse that propagates the

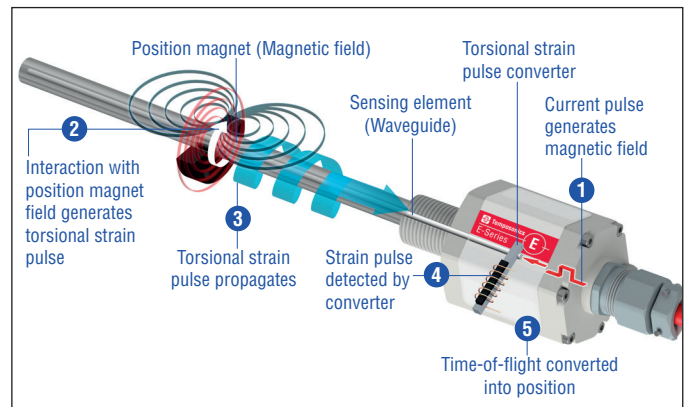

Fig. 3: Time-of-flight based magnetostrictive position sensing principle

length of the waveguide. When the ultrasonic wave reaches the end of the waveguide it is converted into an electrical signal. Since the speed of the ultrasonic wave in the waveguide is precisely known, the time required to receive the return signal can be converted into a linear position measurement with both high accuracy and repeatability.

Modular mechanical and electronic construction

- The sensor profile or rod protects the inner sensor element.
- The sensor electronics housing, a rugged stainless steel construction, contains the complete electronic interface with active signal conditioning.
- The external position magnet is a permanent magnet. Mounted on the mobile machine part, it travels along the sensor profile or rod and triggers the measurement through the sensor profile/rod wall.
- The sensor can be connected directly to a control system. Its electronics generates a strictly position proportional signal output between start and end position.

4.2 Installation and design of Temposonics® ET (rod sensor)

ET-F/-M/-S/-W, example: Version A/N

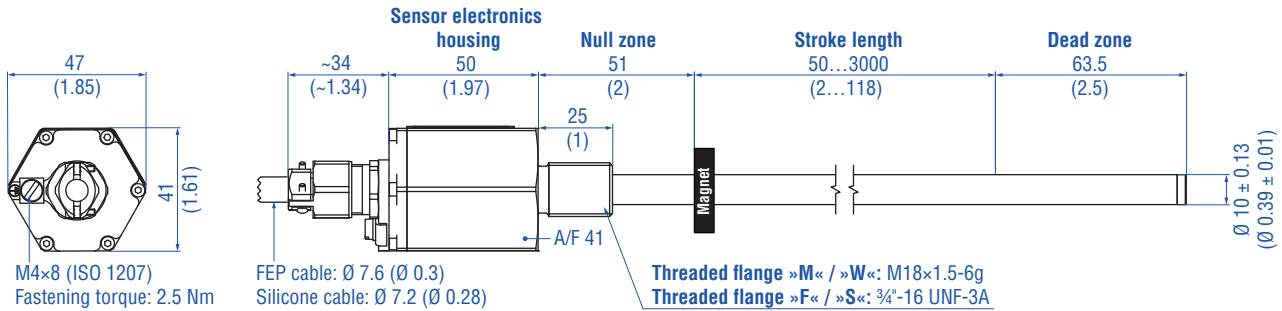

ET-F/-M/-S/-W, example: Version E

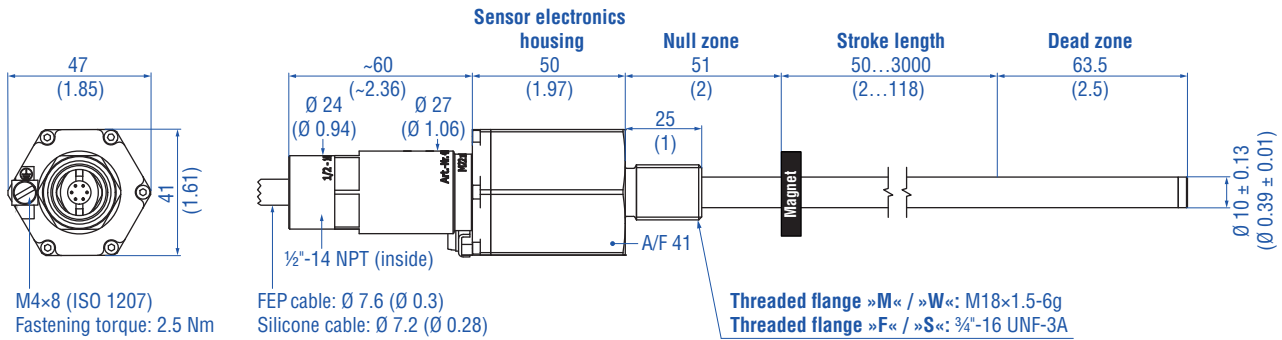

Controlling design dimensions are in millimeters and measurements in () are in inches

Fig. 4: Temposonics® ET (rod sensor) with ring magnet

Installation of ET with threaded flange »F«, »M«, »S« & »W«

Fix the sensor rod via threaded flange M18×1.5-6g or ¾"-16 UNF-3A. Lightly oil the thread before tightening. Lightly oil the thread before tightening.

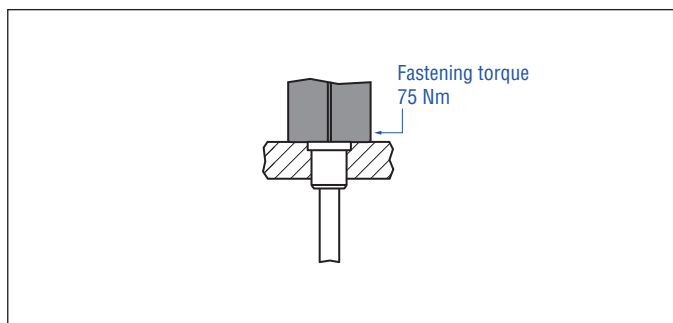

Fig. 5: Mounting example of threaded flange »F«, »M«, »S«, »W«

Installation of a rod-style sensor in a fluid cylinder

The rod-style version has been developed for direct stroke measurement in a fluid cylinder. Mount the sensor via threaded flange or a hex nut.

- Mounted on the face of the piston, the position magnet travels over the rod without touching it and indicates the exact position through the rod wall – independent of the hydraulic fluid.
- The pressure resistant sensor rod is installed into a bore in the piston rod.

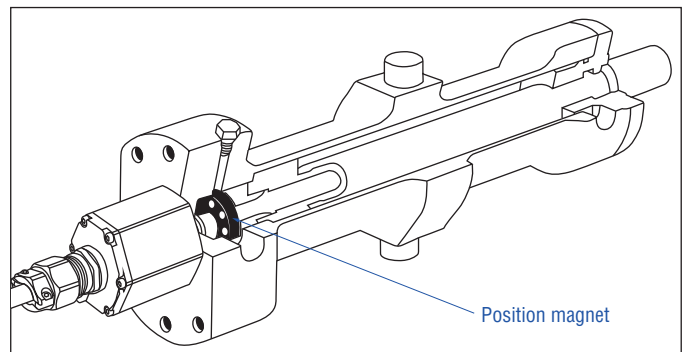

Fig. 6: Sensor in cylinder

Hydraulics sealing

There are two ways to seal the flange contact surface (Fig. 7):

1. A sealing by using an O-ring (e.g. 22.4 × 2.65 mm (0.88 × 0.1 in.), 25.07 × 2.62 mm (0.99 × 0.1 in.)) in a cylinder end cap groove.
2. A sealing by using an O-ring in the undercut.

For threaded flange (3/4"-16 UNF-3A) »F«/»S«:

O-ring 16.4 × 2.2 mm (0.65 × 0.09 in.) (part no. 560 315)

For threaded flange (M18×1.5-6g) »M«/»W«:

O-ring 15.3 × 2.2 mm (0.60 × 0.09 in.) (part no. 401 133)

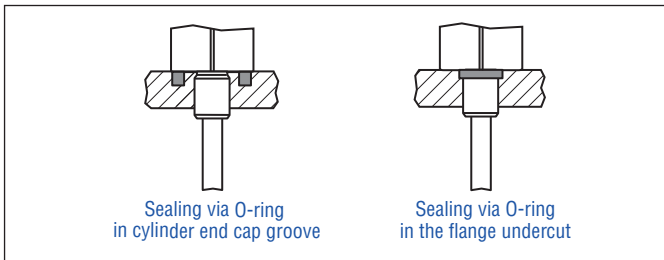

Fig. 7: Possibilities of sealing

- Note the fastening torque of 75 Nm.
- Seat the flange contact surface completely on the cylinder mounting surface.
- The cylinder manufacturer determines the pressure-resistant gasket (copper gasket, O-ring, etc.).
- The position magnet should not grind on the sensor rod.
- The piston rod drilling ($\geq \varnothing 13$ mm ($\geq \varnothing 0.51$ in.)) depends on the pressure and piston speed.
- Adhere to the information relating to operating pressure.
- Protect the sensor rod against wear.

In the case of threaded flange M18×1.5-6g provide a screw hole based on ISO 6149-1 (Fig. 8). See ISO 6149-1 for further information.

| Notice for metric threaded flange | | | | | | | | | |
|-----------------------------------|-------|-----------|-------|-----------|-----------|-------|-------|-------------|---------------|
| Thread ($d_1 \times P$) | d_2 | d_3 | d_4 | d_5 | L_1 | L_2 | L_3 | L_4 | Z° |
| | | | | +0.1 0 | +0.4 0 | | | | $\pm 1^\circ$ |
| ET-F/-M/-S/-W | | | | | | | | | |
| M18×1.5-6g | 55 | ≥ 13 | 24.5 | 19.8 | 2.4 | 28 | 2 | ≥ 25.5 | 15° |

Controlling design dimensions are in millimeters

Fig. 8: Notice for metric threaded flange M18×1.5-6g based on DIN ISO 6149-1

4.3 Installation and design of Temposonics® ET (profile sensor)

ET-P, example: Version A/N

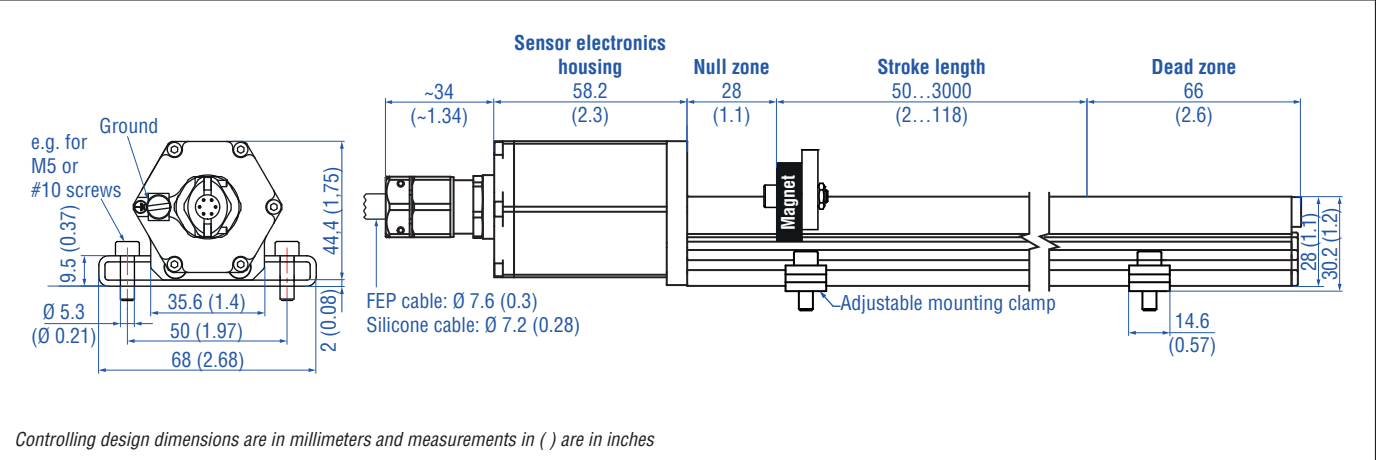

Fig. 9: Temposonics® ET (profile sensor) with U-magnet

Installation of ET-P (profile sensor)

The position sensor can be installed in any position. Normally, the sensor is firmly installed and the position magnet is fastened to the mobile machine part. Thus it can travel along the sensor profile. The sensor is fitted on a flat machine surface using the mounting clamps (Fig. 10). A length-dependent number of these clamps are delivered with the sensor and must be distributed over the profile at regular distances. For fastening we recommend using M5x20 screws (DIN 6912) that should be tightened with a fastening torque of 5 Nm.

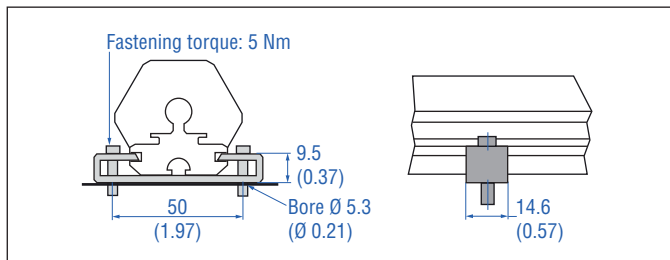

Fig. 10: Mounting clamps (part no. 400 802) with cylinder screw M5x20

Alternative:

If only limited space is available, the profile sensor can be mounted also via the T-rail in the profile bottom using a T-slot nut M5 (part no. 401 602) or a sliding block (Fig. 11).

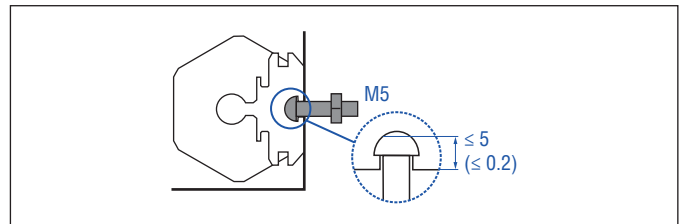

Fig. 11: T-slot nut M5 (part no. 401 602)

NOTICE

Take care to mount the sensor in an axially parallel position to avoid damage to magnet and sensor.

4.4 Magnet installation

Typical use of magnets



| Magnet | Typical sensors | Benefits |
|--|---|--|
|  Ring magnets | Rod model (ET-F/-W/-M/-S) | <ul style="list-style-type: none"> Rotationally symmetrical magnetic field |
|  U-magnets | Profile & rod models (ET-P/-F/-W/-M/-S) | <ul style="list-style-type: none"> Height tolerances can be compensated, because the magnet can be lifted off |
|  Block magnets | Profile & rod models (ET-P/-F/-W/-M/-S) | <ul style="list-style-type: none"> Height tolerances can be compensated, because the magnet can be lifted off |
|  Magnet sliders | Profile models (ET-P) | <ul style="list-style-type: none"> The magnet is guided by the profile The distance between the magnet and the waveguide is strictly defined Easy coupling via the ball joint |

Fig. 12: Typical use of magnets

Mounting ring magnets, U-magnets & block magnets

Install the magnet using non-magnetic material for mounting device, screws, spacers etc.. The magnet must not grind on the sensor rod/profile. Alignment errors are compensated via the air gap.

- Permissible surface pressure: Max. 40 N/mm² (only for ring magnets and U-magnets)
- Fastening torque for M4 screws: 1 Nm; use washers, if necessary
- Minimum distance between position magnet and any magnetic material has to be 15 mm (0.6 in.) (Fig. 15).
- If no other option exists and magnetic material is used, observe the specified dimensions (Fig. 15).

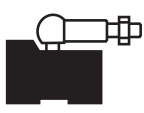
NOTICE

- Mount ring magnets and U-magnets concentrically.
- Mount block magnets centrically over the sensor rod or the sensor profile. The maximum permissible air gap must not be exceeded (Fig. 13/ Fig. 14). Take care to mount the primary sensor axis in parallel to the magnet path in order to avoid damage to the carriage, magnet and sensor rod/profile.

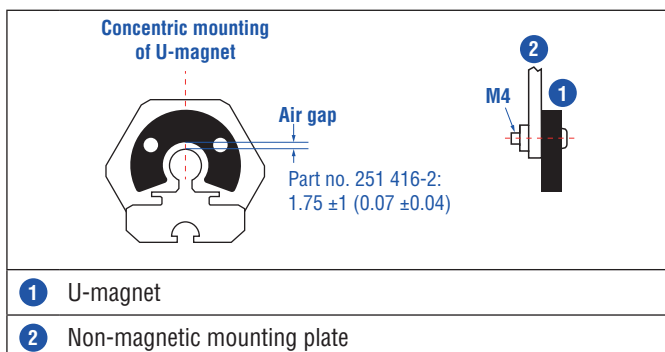

Fig. 13: Mounting of U-magnet (part no. 251 416-2)

Controlling design dimensions are in millimeters and measurements in () are in inches

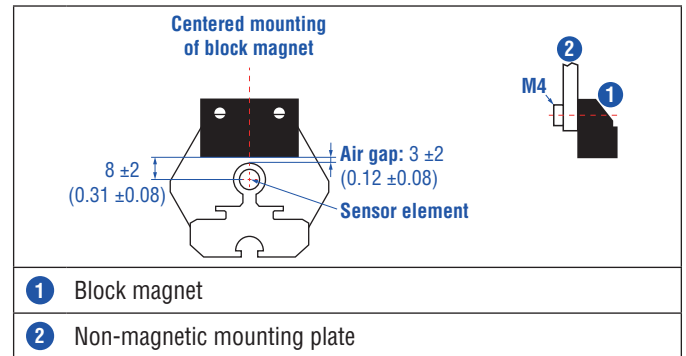

Fig. 14: Mounting of block magnet (part no. 403 448)

Magnet mounting with magnetic material

When using magnetic material the dimensions of Fig. 15 must be observed.

- A.** If the position magnet aligns with the drilled piston rod
- B.** If the position magnet is set further into the drilled piston rod, install another non-magnetic spacer (e.g. part no. 400 633) above the magnet.

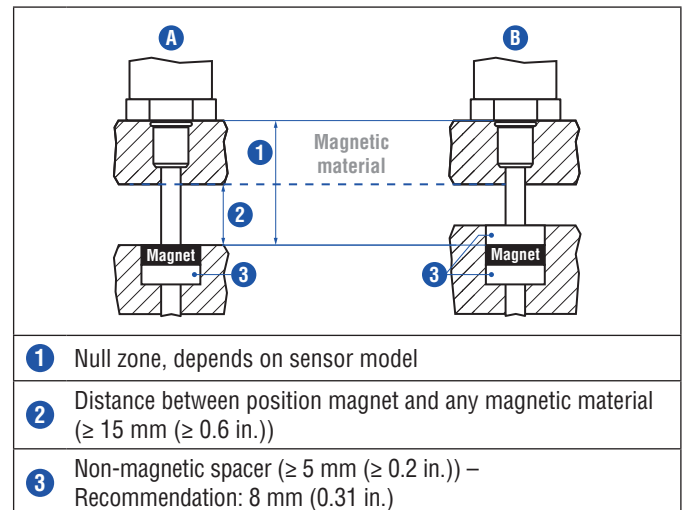

Fig. 15: Installation with magnetic material

Rod sensors with stroke lengths ≥ 1 meter (3.3 ft.)

Support horizontally installed sensors with a stroke length of 1 meter (3.3 ft.) and more mechanically at the rod end. Without the use of a support, rod and position magnet may be damaged. A false measurement result is also possible. Longer rods require evenly distributed mechanical support over the entire length (e.g. part no. 561 481). Use an U-magnet (Fig. 16) for measurement.

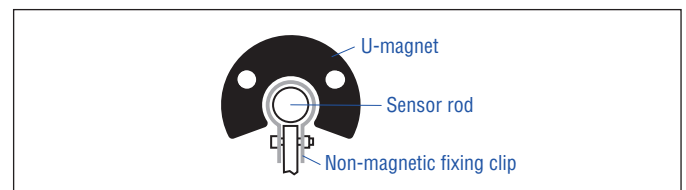

Fig. 16: Example of sensor support (part no. 561 481)

Start and end positions of the position magnets

Consider the start and end positions of the position magnets during the installation. To ensure that the entire stroke length is electrically usable, the position magnet must be mechanically mounted as follows.

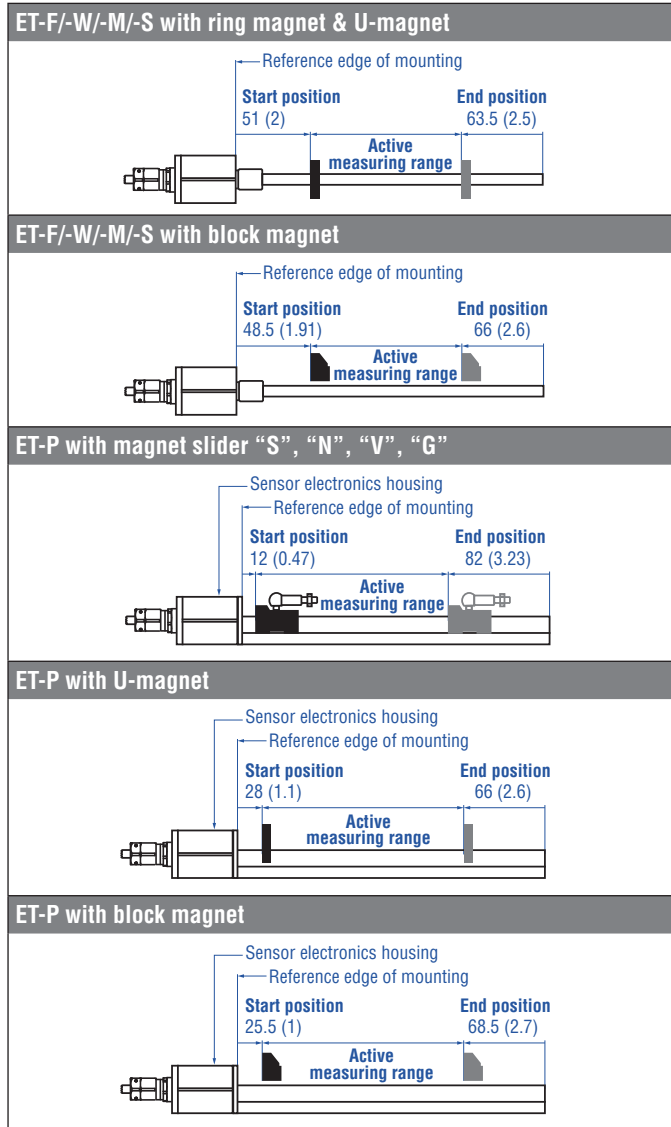

Fig. 17: Start and end positions of magnets

NOTICE
 On all sensors, the areas left and right of the active stroke length are provided for null and dead zone (see "4.2 Styles and installation of Temposonics® ET (rod sensor)" on page 8). These zones should not be used for measurement, however the active stroke length can be exceeded.

Multi-position measurement

The minimum distance between the magnets is 75 mm (3 in.) (used with all types of magnets).

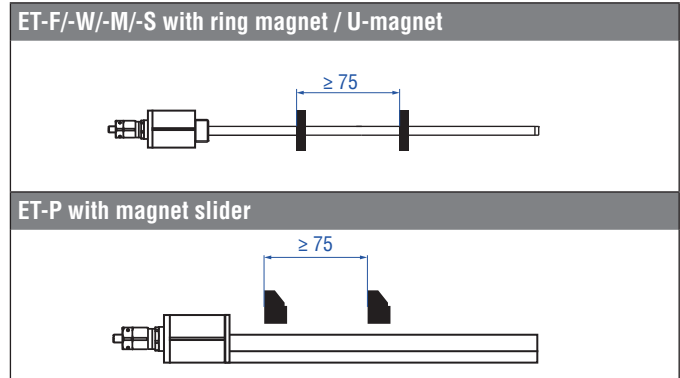

Fig. 18: Examples: Minimum distance for multi-position measurement

NOTICE
 For multi-position measurement, use magnets of the same type. Do not underscore the minimum distance between the magnets of 75 mm (3 in.) for multi-position measurement. Contact Temposonics if you need a magnet distance < 75 mm (3 in.).

4.5 Electrical connection

Placement of installation and cabling have decisive influence on the sensor's electromagnetic compatibility (EMC). Hence correct installation of this active electronic system and the EMC of the entire system must be ensured by using suitable metal connectors, shielded cables and grounding. Overvoltages or faulty connections can damage the sensor electronics despite protection against wrong polarity.

NOTICE

1. Do not mount the sensors in the area of strong magnetic or electric noise fields.
2. Never connect/disconnect the sensor when voltage is applied.

Instruction for connection

- Connect the shield to ground externally via the controller equipment.
- Keep control and signal leads separate from power cables and sufficiently far away from motor cables, frequency inverters, valve lines, relays, etc..
- Use only connectors with metal housing, if you use a connector. Connect the shielding to the connector housing.
- Keep all non-shielded leads as short as possible.
- Keep the earth connection as short as possible with a large cross section. Avoid ground loops.
- With potential differences between machine and electronics earth connections, no compensating currents are allowed to flow across the cable shielding.
Recommendation:
 Install potential compensating leads with large cross section.
- Use only stabilized power supplies in compliance with the specified electrical ratings.

Grounding of rod sensors

Connect the sensor electronics housing to machine ground. Ground sensor type ET version A (with ATEX/UK Ex/IECEX/CEC/NEC/CCC approval) via ground lug as shown in Fig. 19. Ground the sensor type ET version N (not approved) via ground lug as shown in Fig. 19 or via thread. Ground sensor type ET version E (with ATEX/UK Ex/IECEX/CEC/NEC/CCC approval) via ground lug as shown in Fig. 20.

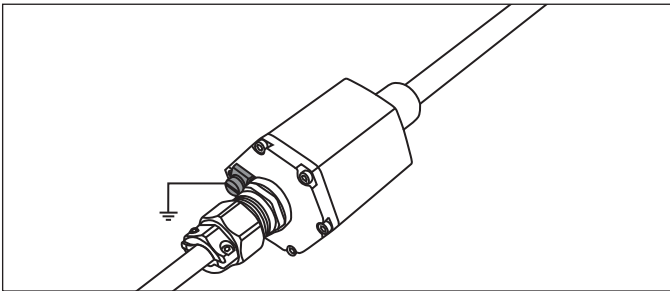

Fig. 19: Grounding via ground lug (version A, N)

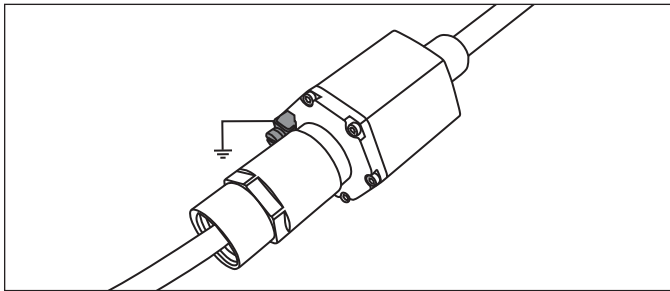

Fig. 20: Grounding via ground lug (version E)

Connector wiring

Connect the sensor directly to the controller, indicator or other evaluating systems as follows:

| TXX/VXX | | | |
|-----------------------|-------|--|---|
| Signal + power supply | | | |
| Cable | Color | Voltage | Current |
| | GY | Output 1: 0...10 VDC or 10...0 VDC | Output 1: 4(0)...20 mA or 20... 4(0) mA |
| | PK | DC Ground for output 1 | DC Ground for output 1 |
| | YE | Output 2: 0...10 VDC or 10...0 VDC | Output 2: 4(0)...20 mA or 20... 4(0) mA |
| | GN | DC Ground for output 2 | DC Ground for output 2 |
| | BN | +24 VDC (-15/+20 %) | +24 VDC (-15/+20 %) |
| | WH | DC Ground (0 V) | DC Ground (0 V) |

Fig. 21: Connector wiring TXX/VXX

4.6 Frequently ordered accessories for ET-F/W/M/S – Additional options available in our [Accessories Catalog](#) 551 444

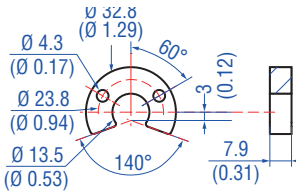
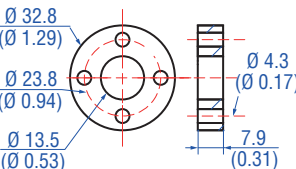
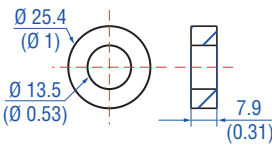
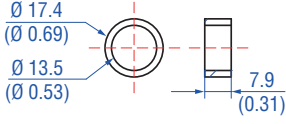
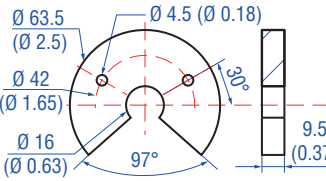
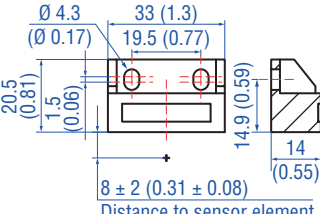
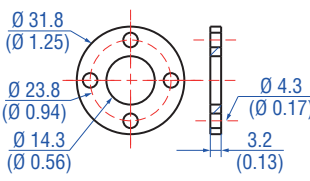
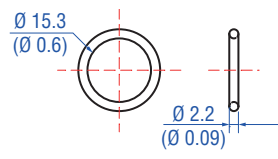
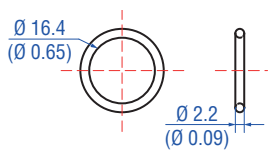
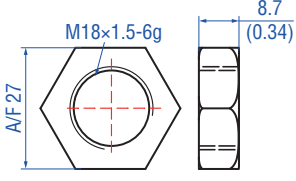
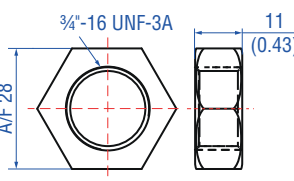
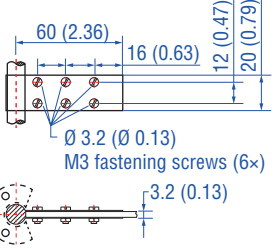
| Position magnets | | | |
|---|---|--|---|
|  |  |  |  |
| <p>U-magnet OD33 Part no. 251 416-2</p> | <p>Ring magnet OD33 Part no. 201 542-2</p> | <p>Ring magnet OD25.4 Part no. 400 533</p> | <p>Ring magnet OD17.4 Part no. 401 032</p> |
| <p>Material: PA ferrite GF20 Weight: Approx. 11 g Surface pressure: Max. 40 N/mm² Fastening torque for M4 screws: 1 Nm Operating temperature: -40...+105 °C (-40...+221 °F)</p> | <p>Material: PA ferrite GF20 Weight: Approx. 14 g Surface pressure: Max. 40 N/mm² Fastening torque for M4 screws: 1 Nm Operating temperature: -40...+105 °C (-40...+221 °F)</p> | <p>Material: PA ferrite Weight: Approx. 10 g Surface pressure: Max. 40 N/mm² Operating temperature: -40...+105 °C (-40...+221 °F)</p> | <p>Material: PA neobond Weight: Approx. 5 g Surface pressure: Max. 20 N/mm² Operating temperature: -40...+105 °C (-40...+221 °F)</p> |
| Position magnets | | Magnet spacer | O-ring |
|  |  |  |  |
| <p>U-magnet OD63.5 Part no. 201 553</p> | <p>Block magnet L Part no. 403 448</p> | <p>Magnet spacer Part no. 400 633</p> | <p>O-ring for threaded flange M18×1.5-6g Part no. 401 133</p> |
| <p>Material: PA 66-GF30, magnets compound-filled Weight: Approx. 26 g Surface pressure: 20 N/mm² Fastening torque for M4 screws: 1 Nm Operating temperature: -40...+75 °C (-40...+167 °F)</p> | <p>Material: Plastic carrier with hard ferrite magnet Weight: Approx. 20 g Fastening torque for M4 screws: 1 Nm Operating temperature: -40...+75 °C (-40...+167 °F)</p> <p>This magnet may influence the sensor performance specifications for some applications.</p> | <p>Material: Aluminum Weight: Approx. 5 g Surface pressure: Max. 20 N/mm² Fastening torque for M4 screws: 1 Nm</p> | <p>Material: Fluoroelastomer Durometer: 75 ± 5 Shore A Operating temperature: -40...+204 °C (-40...+400 °F)</p> |
| O-ring | Mounting accessories | | |
|  |  |  |  |
| <p>O-ring for threaded flange 3/4"-16 UNF-3A Part no. 560 315</p> <p>Material: Fluoroelastomer Durometer: 75 ± 5 Shore A Operating temperature: -40...+204 °C (-40...+400 °F)</p> | <p>Hex jam nut M18×1.5-6g Part no. 500 018</p> <p>Material: Steel, zinc plated</p> | <p>Hex jam nut 3/4"-16 UNF-3A Part no. 500 015</p> <p>Material: Steel, zinc plated</p> | <p>Fixing clip Part no. 561 481</p> <p>Application: Used to secure sensor rods (Ø 10 mm (Ø 0.39 in.)) when using an U-magnet or block magnet Material: Brass, non-magnetic</p> |

Controlling design dimensions are in millimeters and measurements in () are in inches

4.7 Frequently ordered accessories for ET-P – Additional options available in our [Accessories Catalog](#) 551 444

Position magnets

| | | | |
|---|---|---|---|
| | | | |
| <p>Magnet slider S, joint at top Part no. 252 182</p> | <p>Magnet slider V, joint at front Part no. 252 184</p> | <p>Magnet slider N longer ball-joint arm Part no. 252 183</p> | <p>Magnet slider G, backlash free Part no. 253 421</p> |
| <p>Material: GRP, magnet hard ferrite Weight: Approx. 35 g Operating temperature: -40...+85 °C (-40...+185 °F)</p> | <p>Material: GRP, magnet hard ferrite Weight: Approx. 35 g Operating temperature: -40...+85 °C (-40...+185 °F)</p> | <p>Material: GRP, magnet hard ferrite Weight: Approx. 35 g Operating temperature: -40...+85 °C (-40...+185 °F)</p> | <p>Material: GRP, magnet hard ferrite Weight: Approx. 25 g Operating temperature: -40...+85 °C (-40...+185 °F)</p> |

Position magnets

Mounting accessories

| | | | |
|---|---|--|---|
| | | | |
| <p>U-magnet OD33 Part no. 251 416-2</p> | <p>Block magnet L Part no. 403 448</p> | <p>Mounting clamp Part no. 400 802</p> | <p>T-nut Part no. 401 602</p> |
| <p>Material: PA ferrite GF20 Weight: Approx. 11 g Surface pressure: Max. 40 N/mm² Fastening torque for M4 screws: 1 Nm Operating temperature: -40...+105 °C (-40...+221 °F)</p> | <p>Material: Plastic carrier with hard ferrite magnet Weight: Approx. 20 g Fastening torque for M4 screws: 1 Nm Operating temperature: -40...+75 °C (-40...+167 °F)</p> <p>This magnet may influence the sensor performance specifications for some applications.</p> | <p>Material: Stainless steel (AISI 304)</p> | <p>Fastening torque for M5 screw: 4.5 Nm</p> |

4.8 Frequently ordered accessories for Analog output – Additional options available in our [Accessories Catalog](#) 551 444

Cables

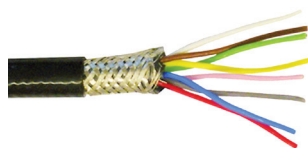

FEP cable
Part no. 530 112

Material: FEP jacket; black
 Features: Twisted pair, shielded, flexible, high thermal resistance, mostly oil & acid resistant
 Cable Ø: 7.6 mm (0.3 in.)
 Cross section: $4 \times 2 \times 0.25 \text{ mm}^2$
 Bending radius: $8 - 10 \times D$ (fixed installation)
 Operating temperature: $-100...+180 \text{ °C}$ ($-148...+356 \text{ °F}$)

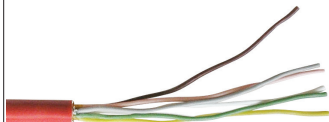

Silicone cable
Part no. 530 113

Material: Silicone jacket; red
 Features: Twisted pair, shielded, highly flexible, halogen free, high thermal resistance
 Cable Ø: 7.2 mm (0.28 in.)
 Cross section: $3 \times 2 \times 0.25 \text{ mm}^2$
 Bending radius: $5 \times D$ (fixed installation)
 Operating temperature: $-50...+180 \text{ °C}$ ($-58...+356 \text{ °F}$)

Programming tools (Not approved for use in hazardous environments)



Hand programmer for analog output
Part no. 253 124

Easy teach-in-setups of stroke length and direction on desired zero / span positions. For sensors with 1 magnet.



Programming kit
Part no. 254 555

Kit includes:
 1 × interface converter box
 1 × power supply
 1 × cable (60 cm) with M12 female connector (5 pin), straight – D-sub female connector (9 pin), straight
 1 × cable (60 cm) with M16 female connector (6 pin), straight – D-sub female connector (9 pin), straight
 1 × cable (60 cm) with 3 × terminal clamp – D-sub female connector (9 pin), straight
 1 × USB cable

Software is available at:
www.temposonics.com



Cabinet programmer for analog output
Part no. 253 408

Features snap-in mounting on standard DIN rail (35 mm). This programmer can be permanently mounted in a control cabinet and includes a program/run switch. For sensors with 1 magnet.

5. Operation

5.1 Getting started

The sensor is factory-set to its order sizes and adjusted, i.e. the required output signal corresponds exactly to the selected stroke length.

Example: Output 4...20 mA = 0...100 % stroke length

NOTICE If necessary, the Analog sensors can be re-adjusted using the service tools described below.

NOTICE

Observe during commissioning

1. Before switching on for the first time, check the connection of the sensor carefully.
2. Position the magnet in the measuring range of the sensor during first commissioning and after replacement of the magnet.
3. Ensure that the sensor control system cannot be displaced in an uncontrolled way when switching on.
4. Ensure that the sensor is ready and in operation mode after switching on.
5. Check the pre-set span start and end values of the measuring range (Fig. 17) and correct them via the customer's control system if necessary, or via the Temposonics service tools. The operation of the service tools is described in detail on the following pages.

5.2 Programming and configuration

Analog interface

The Analog sensor can be directly connected to a controller. Its electronics generates a position signal output proportional to the start and end of the active measuring range.

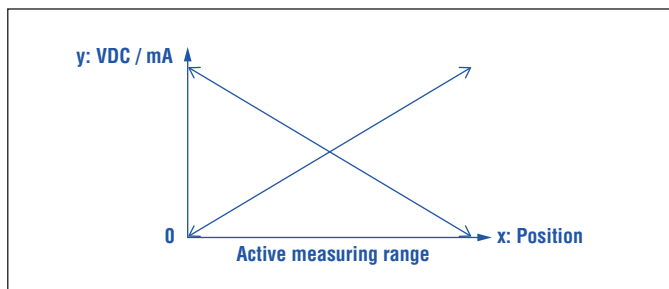

Fig. 22: Analog interface

Temposonics programming tools

Temposonics® position sensors can be adapted to modified measurement tasks very easily via the connecting leads – without opening the sensor. Various Temposonics programming tools from the list of accessories (see page 16) are available for this purpose.

NOTICE The programming tools are not approved for use in a hazardous environment.

5.2.1 Analog hand programmer, part no. 253 124

Connect the hand programmer directly to the sensor. It is possible to change the start and end positions as well as the measuring direction via simple teach in process, see also “5.2.4 Setting examples for programming tools” on page 23. After that, the changed parameters are stored in the sensor. Move the position magnet to the desired start or end position and push the corresponding “0 %” or “100 %” button on the hand programmer. The minimum distance between the new set-points is 25 mm (1 in.). The individual steps are explained in the following section.

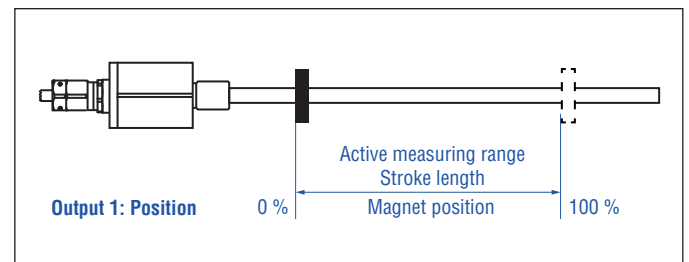

Fig. 23: Active measuring range

Step 1: Connect hand programmer

Step 2: Adjust measuring range

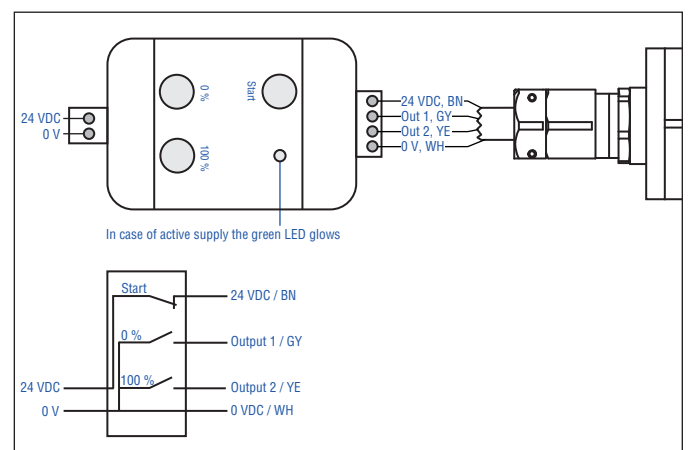

Fig. 24: Connect hand programmer (see connection wiring Fig. 21)

Connect the hand programmer to the power supply and to the sensor according to Fig. 24.

NOTICE
You can only adapt magnet 1 via hand programmer. In order to change the settings of magnet 1 you have to connect both outputs (output 1 and output 2).

3. Set end position (100 % output) (Fig. 26):
 - Set the position magnet on end position
 - Press and release the “100 %” button
4. Back to normal function (operation mode):
 - Press “Start” button
 - Connect the sensor to control unit

- Step 1: Connect hand programmer
- Step 2: Adjust measuring range**

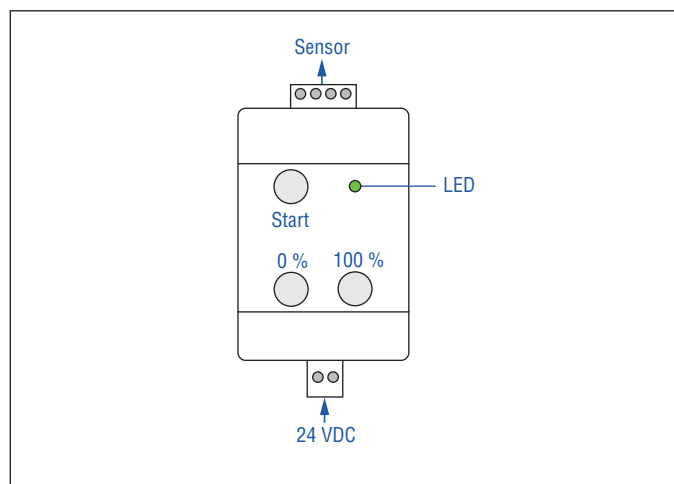

Fig. 25: Adjust measuring range

1. Activate programming mode:
 - Press “Start” button and “100 %” button simultaneously
 - Release “Start” button first, wait 1 second and release “100 %” button
2. Set start position (0 % output) (Fig. 26):
 - Set the position magnet on start position
 - Press and release the “0 %” button

| Output from order code | Output 1 | | Output 2 | |
|------------------------|-----------------------------|-----------------------------|-----------------------------|-----------------------------|
| | Start position (0 % output) | End position (100 % output) | Start position (0 % output) | End position (100 % output) |
| V01 | 0 VDC | 10 VDC | — | — |
| V11 | 10 VDC | 0 VDC | — | — |
| V03 | 0 VDC | 10 VDC | 10 VDC | 0 VDC |
| V02 | 0 VDC | 10 VDC | 0 VDC * | 10 VDC * |
| V12 | 10 VDC | 0 VDC | 10 VDC * | 0 VDC * |
| A01 | 4 mA | 20 mA | — | — |
| A11 | 20 mA | 4 mA | — | — |
| A03 | 4 mA | 20 mA | 20 mA | 4 mA |
| A02 | 4 mA | 20 mA | 4 mA * | 20 mA * |
| A12 | 20 mA | 4 mA | 20 mA * | 4 mA * |

* When using the analog hand programmer only the start and end positions of magnet 1 (output 1) are adjusted. The settings of magnet 2 (output 2) are not affected.

Fig. 26: Determine start and end position

5.2.2 Analog cabinet programmer, part no. 253 408

Install the built-in programming unit firmly in the control cabinet. It is possible to change the start and end positions as well as the measuring direction via simple teach in process, see also “5.2.4 Setting examples for programming tools” on page 23. After that, the changed parameters are stored in the sensor. Move the position magnet to the desired start or end position and push the corresponding “0 %” or “100 %” button on the hand programmer. The minimum distance between the new setpoints is 25 mm (1 in.). The individual steps are explained in the following section.

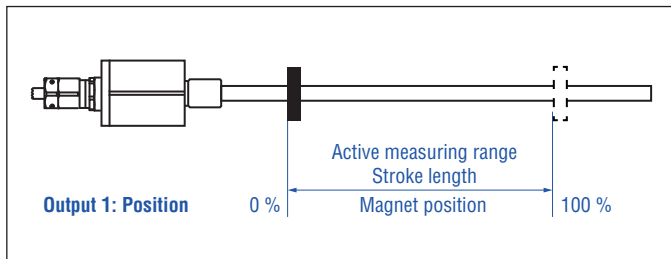

Fig. 27: Active measuring range

- Step 1: Install cabinet programmer
- Step 2: Connect cabinet programmer
- Step 3: Adjust measuring range

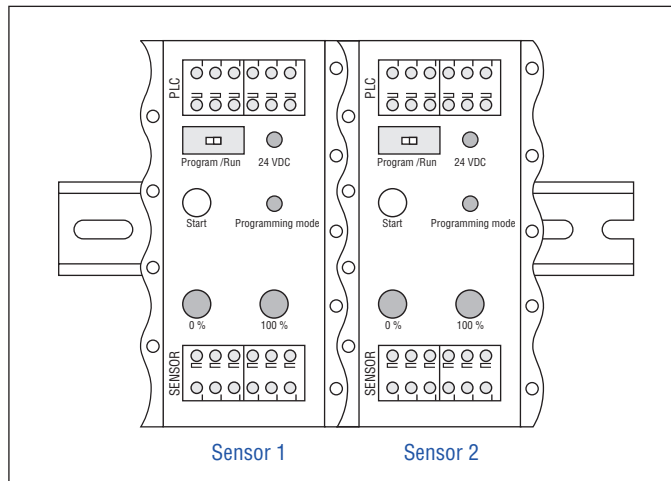

Fig. 28: Dimensions: 10 × 55 × 31 mm (0.39 × 2.17 × 1.22 in.); material: Aluminum, side caps PA 6.6 FR; connection type: Spring terminals, max. 1.5 mm²; ingress protection: IP20

The cabinet programmer is designed for mounting on standard 35 mm (1.38 in.) rails according to DIN EN 60715/50022. Install the cabinet programmer between sensor and controller e.g. in a control cabinet. Using the cabinet programmer the sensor can be easily re-programmed as needed with no additional tools.

- Step 1: Install cabinet programmer
- Step 2: Connect cabinet programmer
- Step 3: Adjust measuring range

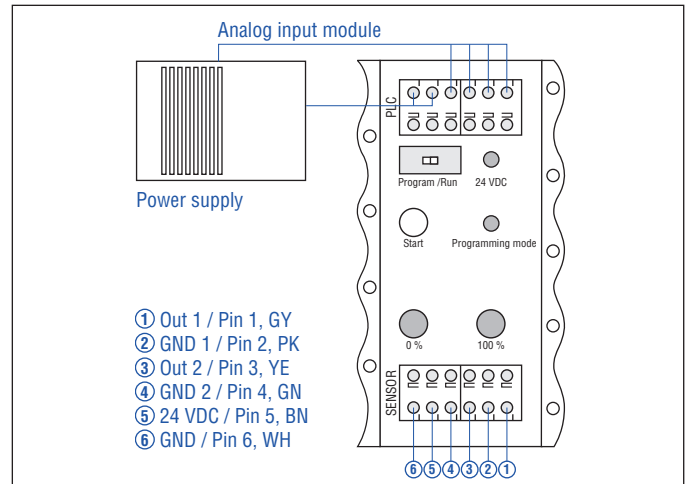

Fig. 29: Connect cabinet programmer (see connector wiring Fig. 21)

Connect the cabinet programmer to the controller, to the power supply and to the sensor according to Fig. 29.

- Step 1: Install cabinet programmer
- Step 2: Connect cabinet programmer
- Step 3: Adjust measuring range

1. Activate programming mode:
 - Slide switch to “Program”
 - Press “Start” button and “100 %” button simultaneously
 - Release “Start” button first, wait 1 second and release “100 %” button
 - Green “Programming mode” LED on cabinet programmer flashes (programming mode reached)

Points 2 – 4 on the next page

2. Set start position (0 % output) (Fig. 30):
- Set the position magnet to start position
 - Press and release the “0 %” button

| Output from order code | Output 1 | | Output 2 | |
|------------------------|-----------------------------|-----------------------------|-----------------------------|-----------------------------|
| | Start position (0 % output) | End position (100 % output) | Start position (0 % output) | End position (100 % output) |
| V01 | 0 VDC | 10 VDC | — | — |
| V11 | 10 VDC | 0 VDC | — | — |
| V03 | 0 VDC | 10 VDC | 10 VDC | 0 VDC |
| V02 | 0 VDC | 10 VDC | 0 VDC * | 10 VDC * |
| V12 | 10 VDC | 0 VDC | 10 VDC * | 0 VDC * |
| A01 | 4 mA | 20 mA | — | — |
| A11 | 20 mA | 4 mA | — | — |
| A03 | 4 mA | 20 mA | 20 mA | 4 mA |
| A02 | 4 mA | 20 mA | 4 mA * | 20 mA * |
| A12 | 20 mA | 4 mA | 20 mA * | 4 mA * |

* When using the analog hand programmer only the start and end positions of magnet 1 (output 1) are adjusted. The settings of magnet 2 (output 2) are not affected.

Fig. 30: Determine start and end position

3. Set end position (100 % output) (Fig. 30):
- Set the position magnet to end position
 - Press and release the “100 %” button
4. Back to normal function (operation mode):
- Press and release the “Start” button
 - LED “Programming mode” stops flashing
 - Slide switch to “Run”
 - Green LED “24 VDC” shows normal function

5.2.3 Programming kit, part no. 254 555

The PC programmer is a hardware converter between sensor and serial PC interface. It can be used for adjusting sensor parameters via computer and the Temposonics programming software, see also “5.2.4 Setting examples for programming tools” on page 23. The software for reading and adjusting the sensors requires a Windows computer with a free USB port. You can adjust the following parameters:

- Start/end position (min. 25 mm (1 in.) between new setpoints)
- Output signal if errors occur (e.g. no position magnet)

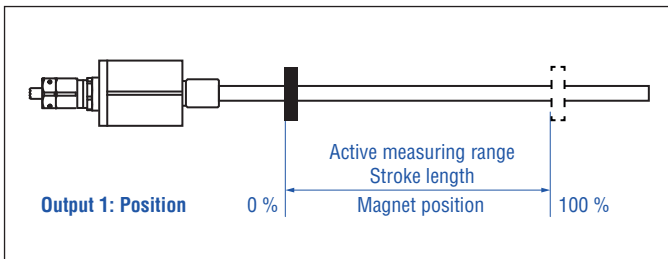

Fig. 31: Active measuring range

Step 1: Connect PC programmer

- Step 2: Install software
 Step 3: Start program

- Connect the PC programmer with the sensor via the corresponding adapter cable
- Connect the PC programmer to a USB port of the computer
- Connect the power supply via connector
The outer contact of the connector is 0 V (ground), the inner contact is 24 VDC

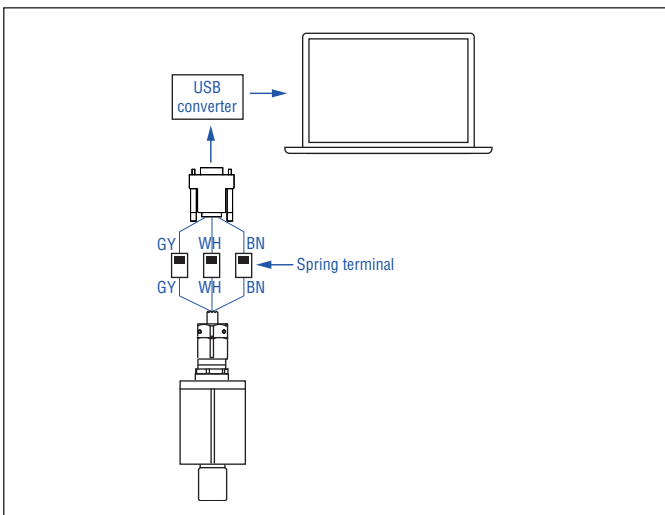

Fig. 32: Connect PC programmer

NOTICE

Never connect/disconnect the sensor when voltage is applied.

- Step 1: Connect PC programmer
 Step 2: Install software
 Step 3: Start program

Download the current software version from www.temposonics.com. Copy the program MTSAnalogConfigurator.exe to your computer and start the program. The program now displays a list of available COMs. A free COM port is selected. The COM port, which was chosen, is displayed in the Device Manager. If a connection fails, it could be a missing driver. In this case, download and install the USB serial converter driver from www.temposonics.com.

- Step 1: Connect PC programmer
 Step 2: Install software
 Step 3: Start program

After starting the program, the user interface of the connected sensor with its adjustable parameters will open (Fig. 33).

Temposonics ET Analog software user interface

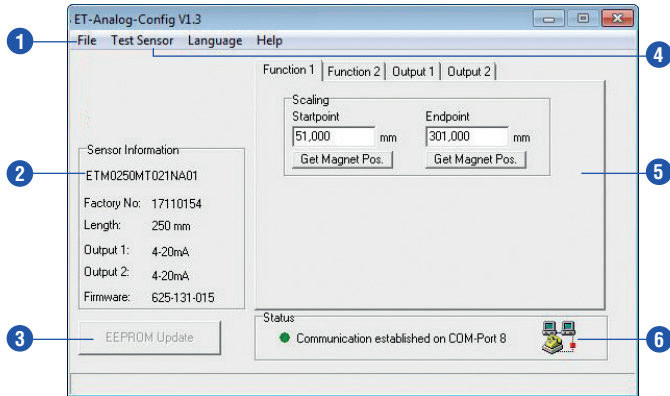

Fig. 33: Temposonics ET-Analog-Config V1.3, Function 1

- 1 In the **File** menu the sensor configuration can be saved on hard disk, printed out or loaded into the sensor³. Moreover, this menu permits returning to the factory setting (Fig. 33).
- 2 **Sensor Information** contains the invariable sensor parameters, which were read in automatically when connecting the sensor. (Fig. 33).
- 3 Any changes which were made are shown with dark background. By clicking on **EEPROM Update** the altered parameters are stored in the sensor permanently. Subsequently, the stored values are displayed again with a white background (Fig. 33).
- 4 Menu **Test Sensor** provides a data display (Fig. 36), which shows the absolute position of the position magnet. Compared with the sensor measuring rate, the serial data transmission between sensor and PC is relatively slow, i.e. not every measured value can be displayed. For this reason, only every 50th measurement value appears in the diagram.
- 5 The control tabs of the main display section permit allocation of functions to the sensor outputs. The measuring range of the functions will be determined in **Scaling** (Fig. 33).
- 6 **Status** indicates that the sensor is connected successfully (Fig. 33).

Dialog field with tabs

- 7 Determine the measuring range with **Startpoint** and **Endpoint** via tab **Function 1** (Fig. 34).
- 8 The current magnet position can be stored via buttons **Get Magnet Pos..**. The measuring direction changes, when the value of the **startpoint** is higher than the value of the **endpoint**. Independent of the measuring direction, the minimum measuring distance is 25 mm (Fig. 34).
- 9 The field **Output Minimum** indicates the current or voltage value which should be output at the startpoint of the selected function. The output value pertaining to the endpoint must be specified in field **Output Maximum** (Fig. 35).

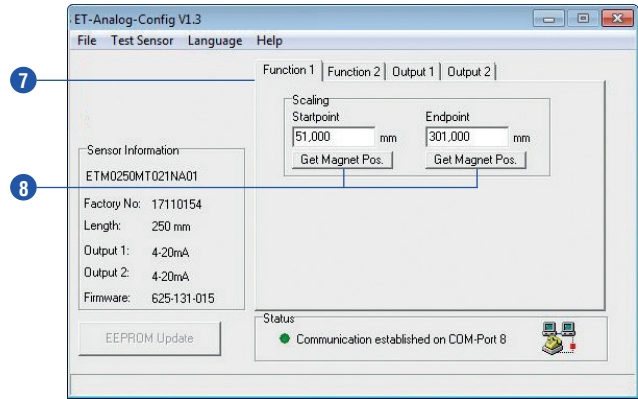

Fig. 34: Dialog field with tabs

- 10 On tabs **Function 2**, **Output 2**, the second analog output can be set (Fig. 35).
- 11 On tab **Output 1** the corresponding analog output signals can be allocated (Fig. 35).
- 12 Unless a position magnet is missing or if it is in the sensor's dead zone, i.e. out of measuring range, **Global Error** is output. The error value can be adjusted within **-0.7...20.3 mA** or **-0.4...10.4 VDC** (Fig. 35).

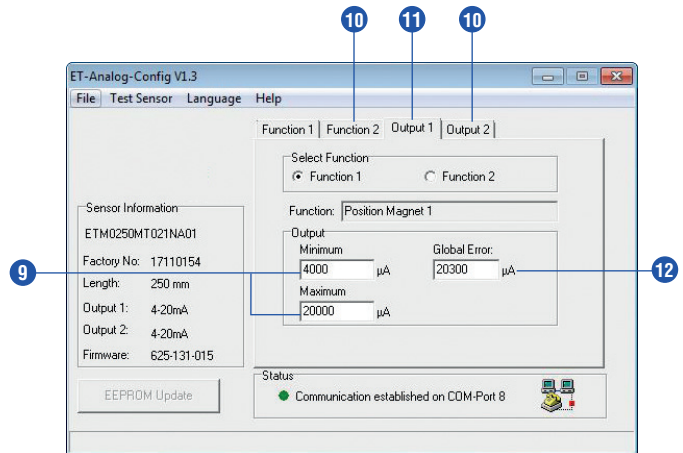

Fig. 35: Example of tab controls

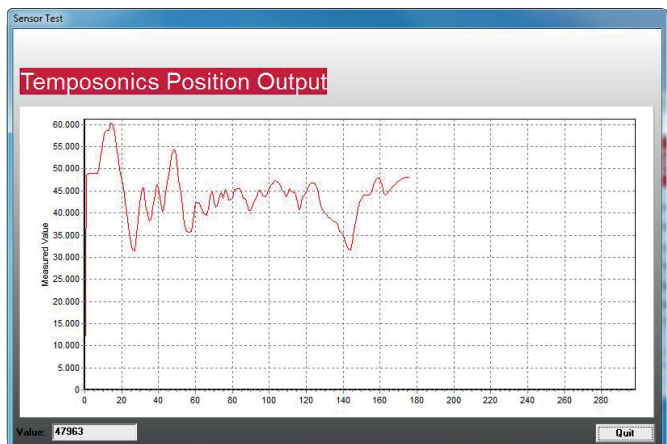

Fig. 36: Data display

3/ Only sensor configurations with the same serial number are permissible

5.2.4 Setting examples for programming tools

The sensor's measuring range can be repositioned within the active measuring range using the tools described above at any time.

NOTICE

Independent of the measuring direction, the location of the setpoints in the factory settings is always: SP1 (set point 1) at sensor electronics housing and SP2 (set point 2) at rod end. (Fig. 37 + Fig. 38).

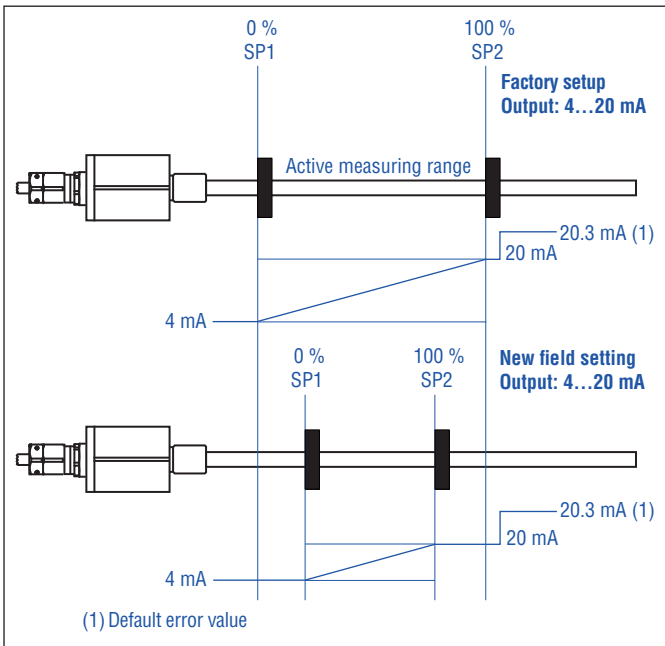

Fig. 37: Adjust start and end position

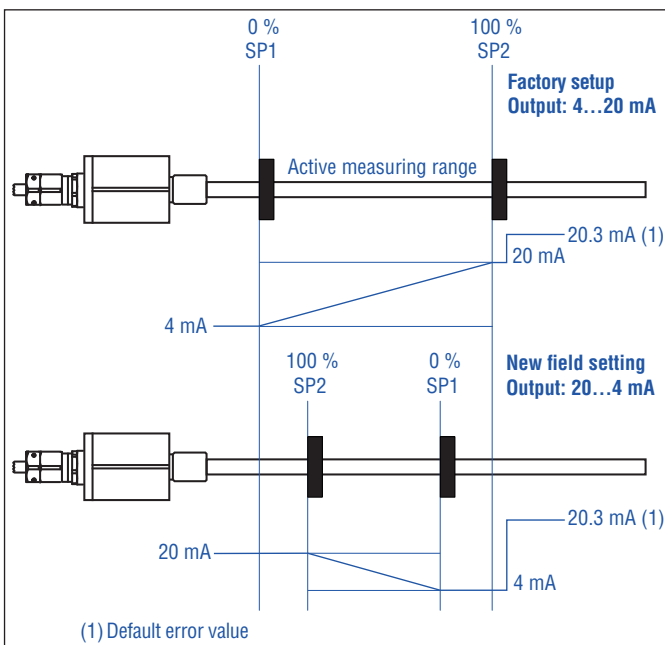

Fig. 38: Start and end position, adjustment/reversal of measuring direction

6. Maintenance and troubleshooting

6.1 Error conditions, troubleshooting

| Error condition | Status |
|-----------------|--|
| Magnet error | Default error value at output: Voltage output: 10.35 V Current output: 20.3 mA Adapted error value at output: -0.7...20.3 mA or -0.4...10.4 VDC (see 12 on page 22) |

Fig. 39: Troubleshooting

6.2 Maintenance

The required inspections need to be performed by qualified personnel according to IEC 60079-17/TRBS 1203. These inspections should include at least a visual inspection of the housing, associated electrical equipment entrance points, retention hardware and equipment grounding. Inside the Ex-atmosphere the equipment has to be cleaned regularly. The user determines the intervals for checking according to the environmental conditions present at the place of operation. After maintenance and repair all protective devices removed for this purpose must be refitted.

In case of equipment faults, remove the equipment. The inner parts cannot be maintained by the customer. In this case send the equipment to the manufacturer for inspection.

NOTICE

It is not allowed to open the sensor.

| Type of inspection | Visual inspection every 3 months | Close inspection every 6 months |
|--|----------------------------------|---------------------------------|
| Visual inspection of the sensor for intactness, removal of dust deposits | ● | |
| Check of entire system | User's responsibility | |

Fig. 40: Schedule of inspection

Maintenance: Defines a combination of any actions carried out to retain an item in, or restore it to, conditions in which it is able to meet the requirements of the relevant specification and perform its required functions.

Inspection: Defines an activity with the purpose to check a product carefully, aiming at a reliable statement on the condition of the product. The inspection is carried out without dismantling, or, if necessary, with partial dismantling, and supplemented by other measures, e.g. measurements.

Visual inspection: Optical inspection of product aims at the recognition of visible defects like missing bolts without using auxiliary equipment and tools.

Close inspection: Defines an inspection which encompasses those aspects covered by a visual inspection and, in addition, identifies those defects, such as loose bolts, which will be apparent only by the use of access equipment, for example steps, where necessary, and tools.

6.3 Repair

Repairs on the sensor may be performed only by Temposonics or an explicitly authorized body.

6.4 List of spare parts

No spare parts are available for this sensor.

6.5 Transport and storage

The conditions of transport and storage of the sensor match the operating conditions mentioned in this document.

7. Removal from service/dismantling

The product contains electronic components and must be disposed of in accordance with the local regulations.

8. Technical data of Temposonics® ET

| Output | | | | | | | | | |
|---------------------------------------|---|---------------|-----------|-----------|-----------|------------|--------|--------|--------|
| Voltage | 0...10 VDC and/or 10...0 VDC (minimum load controller: > 5 kΩ) | | | | | | | | |
| Current | 4(0)...20 mA and/or 20...4(0) mA (minimum/maximum load: 0/500 Ω) | | | | | | | | |
| Measured value | Position | | | | | | | | |
| Measurement parameters | | | | | | | | | |
| Resolution | 16 bit (minimum 1 μm depending on stroke length) ⁴ | | | | | | | | |
| Cycle time | <table border="1" style="display: inline-table; border-collapse: collapse;"> <thead> <tr> <th>Stroke length</th> <th>≤ 1200 mm</th> <th>≤ 2400 mm</th> <th>≤ 3000 mm</th> </tr> </thead> <tbody> <tr> <td>Cycle time</td> <td>0.5 ms</td> <td>1.0 ms</td> <td>2.0 ms</td> </tr> </tbody> </table> | Stroke length | ≤ 1200 mm | ≤ 2400 mm | ≤ 3000 mm | Cycle time | 0.5 ms | 1.0 ms | 2.0 ms |
| Stroke length | ≤ 1200 mm | ≤ 2400 mm | ≤ 3000 mm | | | | | | |
| Cycle time | 0.5 ms | 1.0 ms | 2.0 ms | | | | | | |
| Linearity ⁵ | ≤ ±0.02 % F.S. (minimum ±60 μm) | | | | | | | | |
| Repeatability | ≤ ±0.005 % F.S. (minimum ±20 μm) typical | | | | | | | | |
| Operating conditions | | | | | | | | | |
| Operating temperature | -40...+85 °C (-40...+185 °F) option: -40...+75 °C (-40...+167 °C) | | | | | | | | |
| Humidity | 90 % relative humidity, no condensation | | | | | | | | |
| Ingress protection | With FEP cable (part no. 530 112): IP66 With silicone cable (part no. 530 113): IP68 (2 bar (29 psi) @ 30 min) | | | | | | | | |
| Shock test | 100 g (single shock), IEC standard 60068-2-27 | | | | | | | | |
| Vibration test | Rod: 20 g/10...2000 Hz, IEC standard 60068-2-6 (excluding resonant frequencies) Profile: 15 g/10...2000 Hz, IEC standard 60068-2-6 (excluding resonant frequencies) | | | | | | | | |
| EMC test | Electromagnetic emission according to EN 61000-6-4 Electromagnetic immunity according to EN 61000-6-2 The ET sensors fulfill the requirements of the EMC directives 2014/30/EU, UKSI 2016 No. 1091 and TR CU 020/2011 | | | | | | | | |
| Operating pressure (rod version only) | Up to 350 bar (5076 psi) | | | | | | | | |
| Magnet movement velocity ⁶ | Any | | | | | | | | |
| Design/Material | | | | | | | | | |
| Sensor electronics housing/flange | Stainless steel 1.4305 (AISI 303); option: Stainless steel 1.4404 (AISI 316L) | | | | | | | | |
| Sensor rod | Stainless steel 1.4306 (AISI 304L); option: Stainless steel 1.4404 (AISI 316L) | | | | | | | | |
| Sensor profile | Aluminum | | | | | | | | |
| RoHS compliance | The used materials are compliant with the requirements of EU directive 2011/65/EU and EU regulation 2015/863 as well as UKSI 2012 No. 3032 | | | | | | | | |
| Stroke length | 50...3000 mm (2...118 in.) | | | | | | | | |
| Mechanical mounting | | | | | | | | | |
| Mounting position | Any | | | | | | | | |
| Mounting instruction | Please consult the technical drawings on page 8 and on page 10 | | | | | | | | |
| Electrical connection | | | | | | | | | |
| Connection type | Cable outlet | | | | | | | | |
| Operating voltage | +24 VDC (-15/+20 %) | | | | | | | | |
| Ripple | ≤ 0.28 V _{pp} | | | | | | | | |
| Current consumption | 100 mA typical, dependent on stroke length | | | | | | | | |
| Dielectric strength | 700 VDC (DC ground to machine ground) | | | | | | | | |
| Polarity protection | Up to -30 VDC | | | | | | | | |
| Overvoltage protection | Up to 36 VDC | | | | | | | | |

4/ The internal digital value is transferred via a 16-bit D/A converter into a proportional, analog current or voltage signal

5/ With position magnet # 251 416-2

6/ If there is contact between the moving magnet including the magnet holder and the sensor rod, make sure that the maximal speed of the moving magnet is ≤ 1 m/s (Ex requirement due to ESD [Electro Static Discharge])

| Certification |
|---|
| ⊕ II 3G Ex nC IIC T4 Gc |
| ⊕ II 3D Ex tc IIIC T130 °C Dc |
| ⊕ Class I/II/III Div 2 T4 ABCDFG |
| ⊕ Class I Zone 2 T4 IIC Zone 22 AEx tc T4 IIIC Dc Ex tc IIIC T130 °C Dc IP66/IP68 |
| Ⓢ Ex nC IIC T4 Gc |
| Ⓢ Ex tD A22 IP66/IP68 T130 °C -40 °C ≤ Ta ≤ 85 °C; Type: 4X; IP66/IP68 |

Fig. 41: Certification of Temposonics® ET (version A and E)

9. Appendix

Safety declaration

Dear Customer,

If you return one or several sensors for checking or repair, we need you to sign a safety declaration. The purpose of this declaration is to ensure that the returned items do not contain residues of harmful substances and/or that people handling these items will not be in danger.

Temposonics order number: _____

Sensor type(s): _____

Serial number(s): _____

Sensor length(s): _____

The sensor has been in contact with the following materials:

Do not specify chemical formulas.
 Please include safety data sheets of the substances, if applicable.

In the event of suspected penetration of substances into the sensor, consult Temposonics to determine measures to be taken before shipment.

Short description of malfunction:

Corporate information

Company: _____

Address: _____

Contact partner

Phone: _____

Fax: _____

Email: _____

We hereby certify that the measuring equipment has been cleaned and neutralized.
 Equipment handling is safe. Personnel exposure to health risks during transport and repair is excluded.

Stamp

Signature

Date

Temposonics GmbH & Co.KG Tel. +49 2351/95 87-0
 Auf dem Schüffel 9 Fax. +49 2351/56 49 1
 58513 Lüdenscheid info.de@temposonics.com
 Germany www.temposonics.com

10. Declaration of conformity

EU22.009A

EU Declaration of Conformity

Temposonics

declares as manufacturer in sole responsibility that the position sensor type

Temposonics

ET-x-xxxxx-xxx-1-A-Axx-x
 ET-x-xxxxx-xxx-1-E-Axx-x
 ET-x-xxxxx-xxx-1-A-Vxx-x
 ET-x-xxxxx-xxx-1-E-Vxx-x
 ET-x-xxxxx-xxx-1-A-Sxxxxxx
 ET-x-xxxxx-xxx-1-E-Sxxxxxx

comply with the regulations of the following European Directives:

2014/30/EU Electromagnetic Compatibility

2014/34/EU Equipment and protective systems for use in potentially explosive atmospheres



2011/65/EU Restriction of the use of hazardous substances in electrical and electronic equipment

Applied harmonized standards:

EN IEC 60079-0 :2018
EN IEC 60079-15 :2010
EN 60079-31 :2014
EN 61000-6-2 :2005
EN 61000-6-4 :2007+A1 :2011

Manufacture test report: **605895**

Marking:

 II 3G Ex nC IIC T4 Gc
 II 3D Ex tc IIIC T130°C Dc

EU Konformitätserklärung

Temposonics

erklärt als Hersteller in alleiniger Verantwortung, dass der Positionssensor Typ

Temposonics

ET-x-xxxxx-xxx-1-A-Axx-x
 ET-x-xxxxx-xxx-1-E-Axx-x
 ET-x-xxxxx-xxx-1-A-Vxx-x
 ET-x-xxxxx-xxx-1-E-Vxx-x
 ET-x-xxxxx-xxx-1-A-Sxxxxxx
 ET-x-xxxxx-xxx-1-E-Sxxxxxx

den Vorschriften folgender Europäischen Richtlinien entsprechen:

2014/30/EU Elektromagnetische Verträglichkeit

2014/34/EU Geräte und Schutzsysteme zur Verwendung in explosionsgefährdeten Bereichen



2011/65/EU Beschränkung der Verwendung gefährlicher Stoffe in Elektro- und Elektronikgeräten

Angewandte harmonisierte Normen:

EN IEC 60079-0 :2018
EN IEC 60079-15 :2010
EN 60079-31 :2014
EN 61000-6-2 :2005
EN 61000-6-4 :2007+A1 :2011

Hersteller-Prüfbericht: **605895**

Kennzeichnung:

 II 3G Ex nC IIC T4 Gc
 II 3D Ex tb IIIC T130°C Dc

Déclaration UE de Conformité

Temposonics

déclare en qualité de fabricant sous sa seule responsabilité que les capteurs de position de type

Temposonics

ET-x-xxxxx-xxx-1-A-Axx-x
 ET-x-xxxxx-xxx-1-E-Axx-x
 ET-x-xxxxx-xxx-1-A-Vxx-x
 ET-x-xxxxx-xxx-1-E-Vxx-x
 ET-x-xxxxx-xxx-1-A-Sxxxxxx
 ET-x-xxxxx-xxx-1-E-Sxxxxxx

sont conformes aux prescriptions des directives européennes suivantes:

2014/30/EU Compatibilité électromagnétique

2014/34/EU Appareils et systèmes de protection à être utilisés en atmosphères explosibles



2011/65/EU Limitation de l'utilisation de substances dangereuses dans les équipements électriques et électroniques

Normes harmonisées appliquées:

EN IEC 60079-0 :2018
EN IEC 60079-15 :2010
EN 60079-31 :2014
EN 61000-6-2 :2005
EN 61000-6-4 :2007+A1 :2011

Rapport d'essai du fabricant: **605895**

Marquage:

 II 3G Ex nC IIC T4 Gc
 II 3D Ex tb IIIC T130°C Dc

Luedenscheid, 17 Mar. 2023



Dr.-Ing. Eugen Davidoff
 Approvals Manager

EU Declaration of Conformity
Temposonics

declares as manufacturer in sole responsibility that the position sensor type

Temposonics

ET-x-xxxxx-xxx-1-N-Axx-x
 ET-x-xxxxx-xxx-1-N-Vxx-x
 ET-x-xxxxx-xxx-1-N-Sxxxxxx

comply with the regulations of the following European Directives:

2014/30/EU Electromagnetic Compatibility

2011/65/EU Restriction of the use of hazardous substances in electrical and electronic equipment

Applied harmonized standards:

EN 61000-6-2 :2005
EN 61000-6-4 :2007+A1 :2011

EU Konformitätserklärung
Temposonics

erklärt als Hersteller in alleiniger Verantwortung, dass der Positionssensor Typ

Temposonics

ET-x-xxxxx-xxx-1-N-Axx-x
 ET-x-xxxxx-xxx-1-N-Vxx-x
 ET-x-xxxxx-xxx-1-N-Sxxxxxx

den Vorschriften folgender Europäischen Richtlinien entsprechen:

2014/30/EU Elektromagnetische Verträglichkeit

2011/65/EU Beschränkung der Verwendung gefährlicher Stoffe in Elektro- und Elektronikgeräten

Angewandte harmonisierte Normen:

EN 61000-6-2 :2005
EN 61000-6-4 :2007+A1 :2011

Déclaration UE de Conformité
Temposonics

déclare en qualité de fabricant sous sa seule responsabilité que les capteurs de position de type

Temposonics

ET-x-xxxxx-xxx-1-N-Axx-x
 ET-x-xxxxx-xxx-1-N-Vxx-x
 ET-x-xxxxx-xxx-1-N-Sxxxxxx

sont conformes aux prescriptions des directives européennes suivantes:

2014/30/EU Compatibilité électromagnétique

2011/65/EU Limitation de l'utilisation de substances dangereuses dans les équipements électriques et électroniques

Normes harmonisées appliquées:

EN 61000-6-2 :2005
EN 61000-6-4 :2007+A1 :2011

Luedenscheid, 17 Mar. 2023



Dr.-Ing. Eugen Davidoff
 Approvals Manager

UK Declaration of Conformity

Temposonics

declares as manufacturer in sole responsibility that the position sensor type

Temposonics

ET-x-xxxxx-xxx-1-A-Axx-x
 ET-x-xxxxx-xxx-1-E-Axx-x
 ET-x-xxxxx-xxx-1-A-Vxx-x
 ET-x-xxxxx-xxx-1-E-Vxx-x
 ET-x-xxxxx-xxx-1-A-Sxxxxxx
 ET-x-xxxxx-xxx-1-E-Sxxxxxx

comply with the regulations of the following UK Directives:

UKSI 2016 :1091 Electromagnetic Compatibility

UKSI 2016 :1107 The Equipment and Protective Systems Intended for Use in Potentially Explosive Atmospheres

UKSI 2012 :3032 Restriction of the use of hazardous substances in electrical and electronic equipment (as amended)

Applied harmonized approved standards:

EN IEC 60079-0 :2018
 EN IEC 60079-15 :2010
 EN 60079-31 :2014
 EN 61000-6-2 :2005
 EN 61000-6-4 :2007+A1 :2011

Manufacture test report: **605895**

Marking:

 II 3G Ex nc IIC T4 Gc
 II 3D Ex tc IIIC T130°C Dc

UK Konformitätserklärung

Temposonics

erklärt als Hersteller in alleiniger Verantwortung, dass der Positionssensor Typ

Temposonics

ET-x-xxxxx-xxx-1-A-Axx-x
 ET-x-xxxxx-xxx-1-E-Axx-x
 ET-x-xxxxx-xxx-1-A-Vxx-x
 ET-x-xxxxx-xxx-1-E-Vxx-x
 ET-x-xxxxx-xxx-1-A-Sxxxxxx
 ET-x-xxxxx-xxx-1-E-Sxxxxxx

den Vorschriften folgender UK Richtlinien entsprechen:

UKSI 2016 :1091 Elektromagnetische Verträglichkeit

UKSI 2016 :1107 Geräte und Schutzsysteme für Einsatz in explosionsgefährdeten Bereichen



UKSI 2012 :3032 Einschränkung zur Verwendung von gefährlichen Stoffen in Elektro- und Elektronikgeräten (mit Ergänzungen)

Angewandte harmonisierte zugelassene Normen:

EN IEC 60079-0 :2018
 EN IEC 60079-15 :2010
 EN 60079-31 :2014
 EN 61000-6-2 :2005
 EN 61000-6-4 :2007+A1 :2011

Hersteller-Prüfbericht: **605895**

Kennzeichnung:

 II 3G Ex nc IIC T4 Gc
 II 3D Ex tc IIIC T130°C Dc

Déclaration de Conformité UK

Temposonics

déclare en qualité de fabricant sous sa seule responsabilité que les capteurs de position de type

Temposonics

ET-x-xxxxx-xxx-1-A-Axx-x
 ET-x-xxxxx-xxx-1-E-Axx-x
 ET-x-xxxxx-xxx-1-A-Vxx-x
 ET-x-xxxxx-xxx-1-E-Vxx-x
 ET-x-xxxxx-xxx-1-A-Sxxxxxx
 ET-x-xxxxx-xxx-1-E-Sxxxxxx

sont conformes aux prescriptions des directives UK suivantes:

UKSI 2016 :1091 Compatibilité électromagnétique

UKSI 2016 :1107 Appareils et systèmes de protection à être utilisés en atmosphères explosibles



UKSI 2012 :3032 Restriction de l'utilisation de substances dangereuses dans les équipements électriques et électroniques (avec amendements)

Normes harmonisées approuvées appliquées:

EN IEC 60079-0 :2018
 EN IEC 60079-15 :2010
 EN 60079-31 :2014
 EN 61000-6-2 :2005
 EN 61000-6-4 :2007+A1 :2011

Rapport d'essai du fabricant: **605895**

Marquage:

 II 3G Ex nc IIC T4 Gc
 II 3D Ex tc IIIC T130°C Dc

Luedenscheid, 10 Mar. 2023



Dr.-Ing. Eugen Davidoff
 Approvals Manager

UK Declaration of Conformity

Temposonics

declares as manufacturer in sole responsibility that the position sensor type

Temposonics

ET-x-xxxxx-xxx-1-N-Axx-x
ET-x-xxxxx-xxx-1-N-Vxx-x
ET-x-xxxxx-xxx-1-N-Sxxxxxx

comply with the regulations of the following UK Directives:

UKSI 2016 :1091 Electromagnetic Compatibility

UKSI 2012 :3032 Restriction of the use of hazardous substances in electrical and electronic equipment (as amended)

Applied harmonized approved standards:

EN 61000-6-2 :2005
EN 61000-6-4 :2007+A1 :2011

UK Konformitätserklärung

Temposonics

erklärt als Hersteller in alleiniger Verantwortung, dass der Positionssensor Typ

Temposonics

ET-x-xxxxx-xxx-1-N-Axx-x
ET-x-xxxxx-xxx-1-N-Vxx-x
ET-x-xxxxx-xxx-1-N-Sxxxxxx

den Vorschriften folgender UK Richtlinien entsprechen:

UKSI 2016 :1091 Elektromagnetische Verträglichkeit

UKSI 2012 :3032 Einschränkung zur Verwendung von gefährlichen Stoffen in Elektro- und Elektronikgeräten (mit Ergänzungen)

Angewandte harmonisierte zugelassene Normen:

EN 61000-6-2 :2005
EN 61000-6-4 :2007+A1 :2011

Déclaration de Conformité UK

Temposonics

déclare en qualité de fabricant sous sa seule responsabilité que les capteurs de position de type

Temposonics

ET-x-xxxxx-xxx-1-N-Axx-x
ET-x-xxxxx-xxx-1-N-Vxx-x
ET-x-xxxxx-xxx-1-N-Sxxxxxx

sont conformes aux prescriptions des directives UK suivantes:

UKSI 2016 :1091 Compatibilité électromagnétique

UKSI 2012 :3032 Restriction de l'utilisation de substances dangereuses dans les équipements électriques et électroniques (avec amendements)

Normes harmonisées approuvées appliquées:

EN 61000-6-2 :2005
EN 61000-6-4 :2007+A1 :2011

Luedenscheid, 10 Mar. 2023



Dr.-Ing. Eugen Davidoff
Approvals Manager



Sensor with Ex approval

Document Part Number:
551890 Revision D (EN) 05/2023

UNITED STATES
Temposonics, LLC
Americas & APAC Region
3001 Sheldon Drive
Cary, N.C. 27513
Phone: +1 919 677-0100
E-mail: info.us@temposonics.com

GERMANY
Temposonics
GmbH & Co. KG
EMEA Region & India
Auf dem Schüffel 9
58513 Lüdenscheid
Phone: +49 2351 9587-0
E-mail: info.de@temposonics.com

ITALY
Branch Office
Phone: +39 030 988 3819
E-mail: info.it@temposonics.com

FRANCE
Branch Office
Phone: +33 6 14 060 728
E-mail: info.fr@temposonics.com

UK
Branch Office
Phone: +44 79 21 83 05 86
E-mail: info.uk@temposonics.com

SCANDINAVIA
Branch Office
Phone: +46 70 29 91 281
E-mail: info.sca@temposonics.com

CHINA
Branch Office
Phone: +86 21 3405 7850
E-mail: info.cn@temposonics.com

JAPAN
Branch Office
Phone: +81 3 6416 1063
E-mail: info.jp@temposonics.com



temposonics.com