

Data Sheet

NEW!
Also with flexible
sensing element
for easy replacement

R-Series V RH5 EtherCAT® Magnetostrictive Linear Position Sensors

- Minimum resolution of 0.5 µm with down to 100 µs cycle time
- Position, velocity and acceleration measurements for up to 30 magnets
- Field adjustments and diagnostics using the TempoLink® and TempoGate® smart assistants

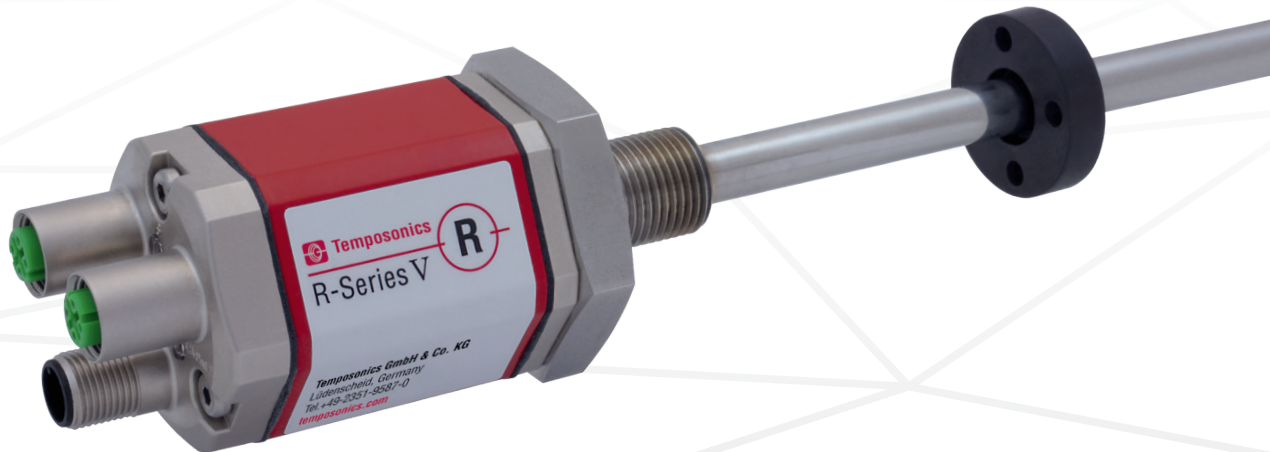

V
THE NEW GENERATION

MEASURING TECHNOLOGY

The absolute, linear position sensors provided by Temposonics rely on the company's proprietary magnetostrictive technology, which can determine position with a high level of precision and robustness. Each Temposonics® position sensor consists of a ferromagnetic waveguide, a position magnet, a strain pulse converter and supporting electronics. The magnet, connected to the object in motion in the application, generates a magnetic field at its location on the waveguide. A short current pulse is applied to the waveguide. This creates a momentary radial magnetic field and torsional strain on the waveguide. The momentary interaction of the magnetic fields releases a torsional strain pulse that propagates the length of the waveguide. When the ultrasonic wave reaches the beginning of the waveguide it is converted into an electrical signal. Since the speed of the ultrasonic wave in the waveguide is precisely known, the time required to receive the return signal can be converted into a linear position measurement with both high accuracy and repeatability.

R-SERIES V RH5 EtherCAT®

The Temposonics® R-Series V brings very powerful sensor performance to meet the many demands of your application. The main advantages of the rod version RH5 with EtherCAT® output are:



High shock and vibration resistance

The R-Series V is the long term solution for harsh environments that have high levels of shock and vibration.



Minimum resolution 0.5 µm

The sensor is characterized by a very stable position signal with a minimum resolution of 0.5 µm.

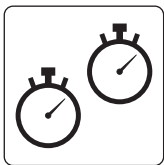

Synchronous measurement

The sensor supports Distributed Clock. The mechanism of distributed clocks enables a synchronized communication with a minimum cycle time as fast as 100 µs.

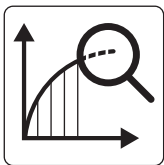

Extrapolation

The sensor supports linear extrapolation. This enables synchronized controller communication at a cycle time of 100 µs for any stroke length of the sensor.

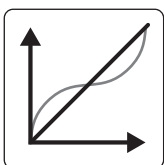

Internal linearization

The sensor is available with internal linearization which offers improved linearity for overall higher accuracy of the position measurement value.

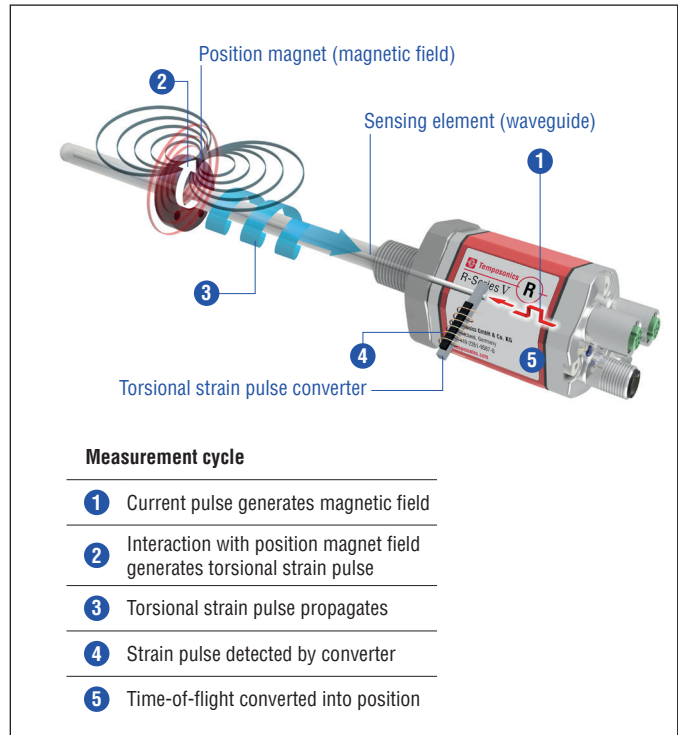

Fig. 1: Time-of-flight based magnetostrictive position sensing principle

In addition the R-Series V EtherCAT® scores with the following features:



30 positions simultaneously

The R-Series V EtherCAT® can detect and report the position, velocity and acceleration of up to 30 magnets simultaneously.



R-Series V EtherCAT®

In addition to the measured position value via the EtherCAT® protocol further data about the current sensor status, such as the total distance travelled, the internal temperature and the total operating hours, can be displayed for diagnostic purposes.

All settings under control with the smart assistants for the R-Series V

The TempoLink® and the TempoGate® smart assistants support you in setup and diagnostics of the R-Series V. For more information of these assistants please see the data sheets:

- TempoLink® smart assistant
(Document part number: [552070](#))
- TempoGate® smart assistant
(Document part number: [552110](#))



RH5 WITH RIGID OR FLEXIBLE SENSING ELEMENT – YOU DECIDE

With the RH5, you can replace the base unit when the sensor is installed in the cylinder without opening the hydraulic circuit. This is possible as the flange with the pressure tube remains in the cylinder. You decide whether the base unit of the RH5 has a rigid or a flexible sensing element:

- RH5 with rigid sensor element: RH5-B/J/M/S/T-A/B/M/V
- RH5 with flexible sensing element: RH5-B/M/S/T-F

The advantages of the rod sensor with flexible sensing element RH5-B/M/S/T-F:

- Only a small amount of space is required when replacing the sensor as the sensing element can be bent
- It can be used as a replacement for an RH5 sensor with a rigid sensing element

Example: RH5-B/J/M/S/T-A/B/M/V (rigid sensing element)

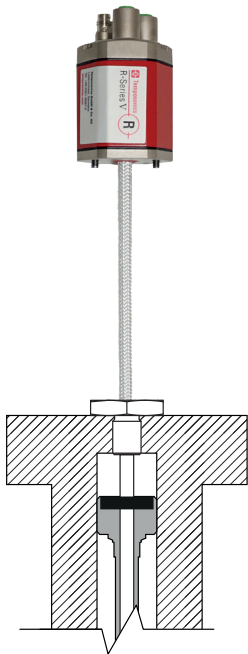

Example: RH5-B/M/S/T-F (flexible sensing element)

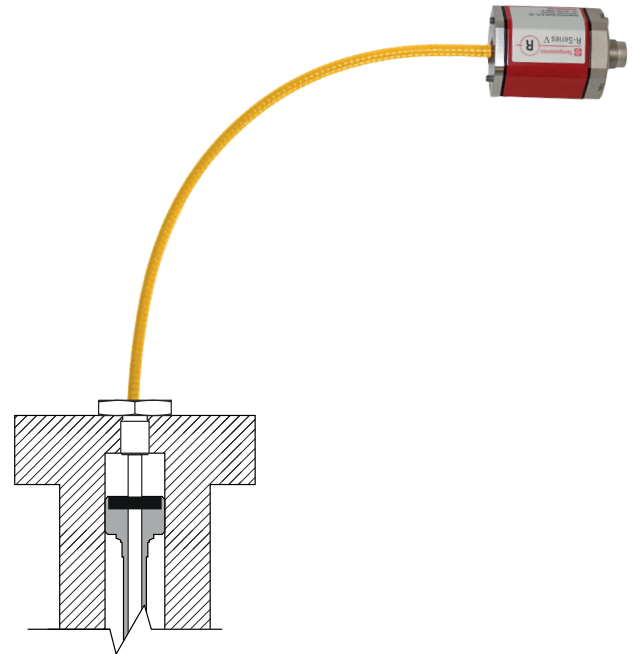

TECHNICAL DATA

Output						
Interface	EtherCAT® Ethernet Control Automation Technology					
Data protocol	EtherCAT® 100 Base-Tx, Fast Ethernet					
Data transmission rate	100 Mbit/s (maximum)					
Measured value	Position, velocity and acceleration/option: Simultaneous multi-position, multi-velocity and multi-acceleration measurements up to 30 magnets					
Measurement parameters						
Resolution: Position	0.5...1000 µm (selectable)					
Native cycle time ¹	Stroke length	≤ 50 mm	≤ 715 mm	≤ 2000 mm	≤ 4675 mm	≤ 7620 mm
	Cycle time	250 µs	500 µs	1000 µs	2000 µs	4000 µs
Extrapolation cycle time	Number of magnets	≤ 10 magnets	11...30 magnets			
	Cycle time	100 µs	250 µs			
Linearity deviation ²	Stroke length	≤ 500 mm	> 500 mm			
	Linearity deviation	≤ ±50 µm	< 0.01 % F.S.			
	Optional internal linearization: Linearity tolerance (applies for the first magnet for multi-position measurement)					
	Stroke length	25...300 mm	300...600 mm	600...1200 mm		
	typical	±15 µm	±20 µm	±25 µm		
	maximum	±25 µm	±30 µm	±50 µm		
Repeatability	< ±0.001 % F.S. (minimum ±2.5 µm)					
Hysteresis	< 4 µm typical					
Temperature coefficient	< 15 ppm/K typical					
Operating conditions						
Operating temperature	-40...+85 °C (-40...+185 °F)					
Humidity	90 % relative humidity, no condensation					
Ingress protection	IP67 (connectors correctly fitted)					
Shock test	150 g/11 ms, IEC standard 60068-2-27					
Vibration test	30 g/10...2000 Hz, IEC 60068-2-6 (excluding resonant frequencies)/					
	RH5-J: 15 g/10...2000 Hz, IEC standard 60068-2-6 (excluding resonant frequencies)					
EMC test	Electromagnetic emission according to EN 61000-6-3					
	Electromagnetic immunity according to EN 61000-6-2					
	The RH5 sensors fulfill the requirements of the EMC directives 2014/30/EU, UKSI 2016 No. 1091 and TR CU 020/2011					
Operating pressure	350 bar (5,076 psi)/700 bar (10,153 psi) peak (at 10 × 1 min) for sensor rod/RH5-J: 800 bar (11,603 psi)					
Magnet movement velocity	Any					
Design/Material						
Sensor electronics housing	Aluminum (painted), zinc die cast					
Sensor flange	Stainless steel 1.4305 (AISI 303)					
Sensor rod	Stainless steel 1.4306/1.4307 (AISI 304L)/RH5-J: Stainless steel 1.4301 (AISI 304)					
RoHS compliance	The used materials are compliant with the requirements of EU directive 2011/65/EU and EU regulation 2015/863 as well as UKSI 2022 No. 622 with amendments					
Stroke length	25...7620 mm (1...300 in.)/RH5-J: 25...5900 mm (1...232 in.)					
Mechanical mounting						
Mounting position	Any					
Mounting instruction	Please consult the technical drawings on page 6 and the operation manual (document number: 552059)					

Technical data "Electrical connection" on [page 5](#)

1/ These values refer to a single position measurement.

2/ With position magnet # 251 416-2

Electrical connection

Connection type	2 × M12 female connectors (5 pin), 1 × M8 male connector (4 pin) or 2 × M12 female connectors (5 pin), 1 × M12 male connector (4 pin)
Operating voltage	12...30 VDC ±20 % (9.6...36 VDC); the RH5 sensors must be power supplied via an external Class 2 power source in accordance with the UL approval
Power consumption	Less than 4 W typical
Dielectric strength	500 VDC (DC ground to machine ground)
Polarity protection	Up to -36 VDC
Overvoltage protection	Up to 36 VDC

TECHNICAL DRAWING

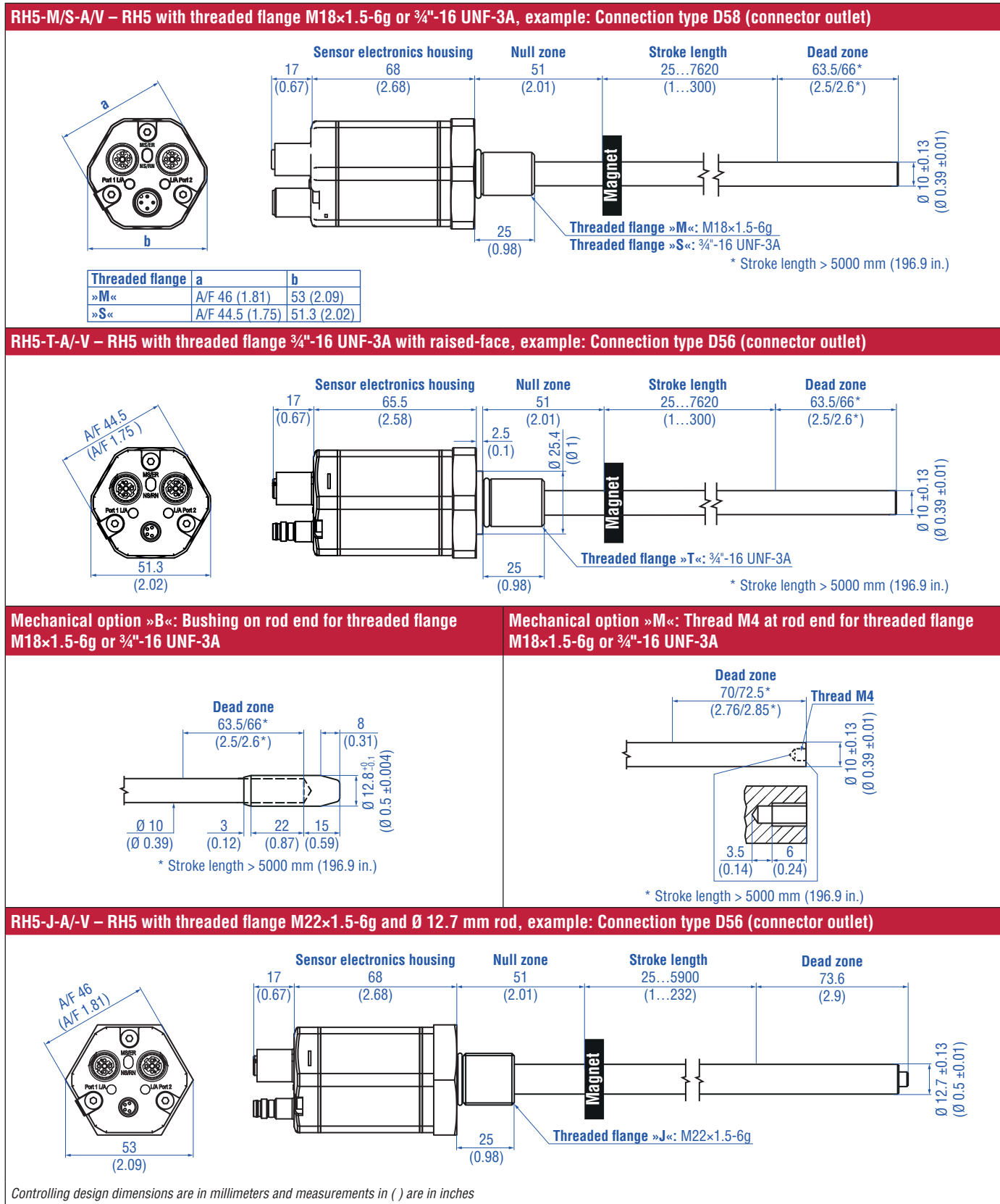

Fig. 2: Temposonics® RH5 with ring magnet

CONNECTOR WIRING



D56		
Port 1 – Signal		
M12 female connector (D-coded)	Pin	Function
 <p>View on sensor</p>	1	Tx (+)
	2	Rx (+)
	3	Tx (-)
	4	Rx (-)
Port 2 – Signal		
M12 female connector (D-coded)	Pin	Function
 <p>View on sensor</p>	1	Tx (+)
	2	Rx (+)
	3	Tx (-)
	4	Rx (-)
Power supply		
M8 male connector	Pin	Function
 <p>View on sensor</p>	1	+12...30 VDC (±20 %)
	2	Not connected
	3	DC Ground (0 V)
	4	Not connected

Fig. 3: Connector wiring D56



D58		
Port 1 – Signal		
M12 female connector (D-coded)	Pin	Function
 <p>View on sensor</p>	1	Tx (+)
	2	Rx (+)
	3	Tx (-)
	4	Rx (-)
Port 2 – Signal		
M12 female connector (D-coded)	Pin	Function
 <p>View on sensor</p>	1	Tx (+)
	2	Rx (+)
	3	Tx (-)
	4	Rx (-)
Power supply		
M12 male connector (A-coded)	Pin	Function
 <p>View on sensor</p>	1	+12...30 VDC (±20 %)
	2	Not connected
	3	DC Ground (0 V)
	4	Not connected

Fig. 4: Connector wiring D58

FREQUENTLY ORDERED ACCESSORIES – Additional options available in our [Accessories Catalog](#) 551444

Position magnets					
<p>U-magnet OD33 Part no. 251 416-2</p> <p>Material: PA ferrite GF20 Weight: Approx. 11 g Surface pressure: Max. 40 N/mm² Fastening torque for M4 screws: 1 Nm Operating temperature: -40...+105 °C (-40...+221 °F) Marked version for sensors with internal linearization: Part no. 254 226</p>	<p>Ring magnet OD33 Part no. 201 542-2</p> <p>Material: PA ferrite GF20 Weight: Approx. 14 g Surface pressure: Max. 40 N/mm² Fastening torque for M4 screws: 1 Nm Operating temperature: -40...+105 °C (-40...+221 °F) Marked version for sensors with internal linearization: Part no. 253 620</p>	<p>Ring magnet OD25.4 Part no. 400 533</p> <p>Material: PA ferrite Weight: Approx. 10 g Surface pressure: Max. 40 N/mm² Operating temperature: -40...+105 °C (-40...+221 °F) Marked version for sensors with internal linearization: Part no. 253 621</p>	<p>Ring magnet Part no. 402 316</p> <p>Material: PA ferrite coated Weight: Approx. 13 g Surface pressure: Max. 20 N/mm² Operating temperature: -40...+100 °C (-40...+212 °F)</p>		
Position magnet		Magnet spacer		O-rings	
<p>Block magnet L Part no. 403 448</p> <p>Material: Plastic carrier with neodymium magnet Weight: Approx. 20 g Fastening torque for M4 screws: 1 Nm Operating temperature: -40...+75 °C (-40...+167 °F)</p> <p>This magnet may influence the sensor performance specifications for some applications.</p>	<p>Magnet spacer Part no. 400 633</p> <p>Material: Aluminum Weight: Approx. 5 g Surface pressure: Max. 20 N/mm² Fastening torque for M4 screws: 1 Nm</p>	<p>O-ring for threaded flange M18×1.5-6g Part no. 401 133</p> <p>Material: Fluoroelastomer Durometer: 75 ±5 Shore A Operating temperature: -40...+204 °C (-40...+400 °F)</p>	<p>O-ring for threaded flange ¾"-16 UNF-3A Part no. 560 315</p> <p>Material: Fluoroelastomer Durometer: 75 ±5 Shore A Operating temperature: -40...+204 °C (-40...+400 °F)</p>		
O-ring		Mounting accessories			
<p>O-ring for threaded flange M22×1.5-6g Part no. 561 337</p> <p>Material: FPM Durometer: 75 Shore A Operating temperature: -20...+200 °C (-6...+392 °F)</p>	<p>Hex jam nut M18×1.5-6g Part no. 500 018</p> <p>Material: Steel, zinc plated</p>	<p>Hex jam nut ¾"-16 UNF-3A Part no. 500 015</p> <p>Material: Steel, zinc plated</p>	<p>Fixing clip Part no. 561 481</p> <p>Application: Used to secure sensor rods (Ø 10 mm (Ø 0.39 in.)) when using an U-magnet or block magnet Material: Brass, non-magnetic</p>		

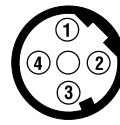
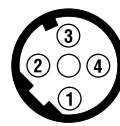
Cable connectors* – Signal

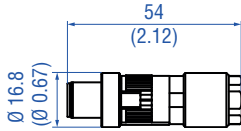

M12 D-coded male connector (4 pin), straight
Part no. 370 523

Material: Zinc nickel-plated
Termination: Insulation-displacement
Cable Ø: 6...7.2 mm (0.2...0.28 in.)
Wire: 24 AWG – 22 AWG
Operating temperature:
–25...+85 °C (–13...+185 °F)
Ingress protection: IP65 / IP67 (correctly fitted)
Fastening torque: 0.6 Nm

Cable connectors* – Power

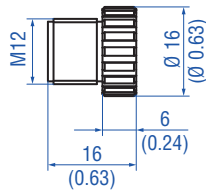

M12 connector end cap
Part no. 370 537

Female connectors M12 should be covered by this protective cap
Material: Brass nickel-plated
Ingress protection: IP67 (correctly fitted)
Fastening torque: 0.39...0.49 Nm

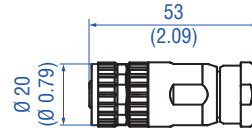

M12 A-coded female connector (4 pin/5 pin), straight
Part no. 370 677

Material: GD-Zn, Ni
Termination: Screw
Contact insert: CuZn
Cable Ø: 4...8 mm (0.16...0.31 in.)
Wire: max. 1.5 mm² (16 AWG)
Operating temperature:
–30...+85 °C (–22...+185 °F)
Ingress protection: IP67 (correctly fitted)
Fastening torque: 0.6 Nm

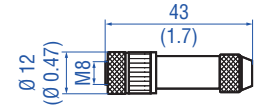

M8 female connector (4 pin), straight
Part no. 370 504

Material: CuZn nickel plated
Termination: Solder
Cable Ø: 3.5...5 mm (0.14...0.28 in.)
Wire: 0.25 mm²
Operating temperature:
–40...+85 °C (–40...+185 °F)
Ingress protection: IP67 (correctly fitted)
Fastening torque: 0.5 Nm

Cables

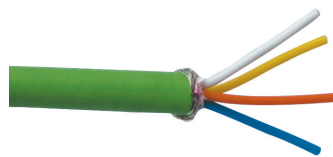

PUR signal cable
Part no. 530 125

Material: PUR jacket; green
Features: Cat 5, highly flexible, halogen free, suitable for drag chains, mostly oil & flame resistant
Cable Ø: 6.5 mm (0.26 in.)
Cross section: 2 × 2 × 0.35 mm² (22 AWG)
Bending radius: 6 × D (fixed installation)
Operating temperature:
–20...+60 °C (–4...+140 °F)

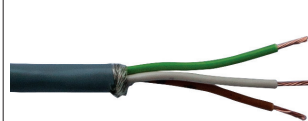

PVC power cable
Part no. 530 108

Material: PVC jacket; gray
Features: Shielded, flexible, mostly flame resistant
Cable Ø: 4.9 mm (0.19 in.)
Cross section: 3 × 0.34 mm²
Bending radius: 5 × D (fixed installation)
Operating temperature:
–30...+80 °C (–22...+176 °F)

Cable sets



Signal cable with M12 D-coded male connector (4 pin), straight – M12 D-coded, male connector (4 pin), straight
Part no. 530 064

Material: PUR jacket; green
Feature: Cat 5e
Cable length: 5 m (16.4 ft)
Cable Ø: 6.5 mm (0.26 in.)
Ingress protection: IP65, IP67, IP68 (correctly fitted)
Operating temperature:
–30...+70 °C (–22...+158 °F)







Signal cable with M12 D-coded male connector (4 pin), straight – RJ45 male connector, straight
Part no. 530 065

Material: PUR jacket; green
Feature: Cat 5e
Cable length: 5 m (16.4 ft)
Cable Ø: 6.5 mm (0.26 in.)
Ingress protection M12 connector: IP67 (correctly fitted)
Ingress protection RJ45 connector: IP20 (correctly fitted)
Operating temperature:
–30...+70 °C (–22...+158 °F)

*/ Follow the manufacturer's mounting instructions
Controlling design dimensions are in millimeters and measurements in () are in inches
Color of connectors and cable jacket may change. Color codes for the individual wires and technical properties remain unchanged.

Temposonics® R-Series V RH5 EtherCAT®

Data Sheet

Cable sets	Programming tools		
			
<p>Power cable with M8 female connector (4 pin), straight – pigtail Part no. 530 066 (5 m (16.4 ft.)) Part no. 530 096 (10 m (32.8 ft.)) Part no. 530 093 (15 m (49.2 ft.))</p>	<p>Power cable with M12 A-coded female connector (5 pin), straight – pigtail Part no. 370 673</p>	<p>TempoLink® kit for Temposonics® R-Series V Part no. TL-1-0-EM08 (D56) Part no. TL-1-0-EM12 (D58)</p>	<p>TempoGate® smart assistant for Temposonics® R-Series V Part no. TG-C-0-Dxx (xx indicates the number of R-Series V sensors that can be connected (even numbers only))</p>
<p>Material: PUR jacket; gray Feature: Shielded Cable Ø: 5 mm (0.2 in.) Operating temperature: -40...+90 °C (-40...+194 °F)</p>	<p>Material: PUR jacket; black Feature: Shielded Cable length: 5 m (16.4 ft) Ingress protection: IP67 (correctly fitted) Operating temperature: -25...+80 °C (-13...+176 °F)</p>	<ul style="list-style-type: none"> • Connect wirelessly via Wi-Fi enabled device or via USB with the diagnostic tool • Simple connectivity to the sensor via 24 VDC power line (permissible cable length: 30 m) • User friendly interface for mobile devices and desktop computers • See data sheet “TempoLink® smart assistant” (document part no.: 552070) for further information 	<ul style="list-style-type: none"> • OPC UA server for diagnostics of the R-Series V • For installation in the control cabinet • Connection via LAN and Wi-Fi • See data sheet “TempoGate® smart assistant” document part no.: 552110 for further information

Color of connectors and cable jacket may change. Colors of the cores and technical properties remain unchanged.

ORDER CODE

1	2	3	4	5	6	7	8	9	10	11	12	13	14	15	16	17	18	19	20
R	H	5										D	5		1	U	1		1
a			b	c	d					e		f			g	h			

a	Sensor model		
R	H	5	Rod

b	Design
B	Base unit (only for replacement)
J	Threaded flange M22×1.5-6g (rod Ø 12.7 mm), stroke length: 25...5900 mm (1...232 in.)
M	Threaded flange M18×1.5-6g (standard)
S	Threaded flange ¾"-16 UNF-3A (standard)
T	Threaded flange ¾"-16 UNF-3A (with raised-face)

c	Mechanical options
A	Standard
B	Bushing on rod end (only for design »M«, »S« & »T«)
F	Flexible sensing element (only for design »B«, »M«, »S« & »T«)
M	Thread M4 at rod end (only for design »M«, »S« & »T«)
V	Fluorelastomer seals for the sensor electronics housing

d	Stroke length				
X	X	X	X	M	0025...7620 mm
Standard stroke length (mm)		Ordering steps			
25... 500 mm		5 mm			
500... 750 mm		10 mm			
750...1000 mm		25 mm			
1000...2500 mm		50 mm			
2500...5000 mm		100 mm			
5000...7620 mm		250 mm			
X	X	X	X	U	001.0...300.0 in.
Standard stroke length (in.)		Ordering steps			
1... 20 in.		0.2 in.			
20... 30 in.		0.4 in.			
30... 40 in.		1.0 in.			
40...100 in.		2.0 in.			
100...200 in.		4.0 in.			
200...300 in.		10.0 in.			
Non-standard stroke lengths are available; must be encoded in 5 mm/0.1 in. increments.					

e	Number of magnets	
X	X	01...30 position(s) (1...30 magnet(s))

f	Connection type		
D	5	6	2 × M12 female connectors (D-coded), 1 × M8 male connector
D	5	8	2 × M12 female connectors (D-coded), 1 × M12 male connector (A-coded)

g	System
1	Standard

h	Output			
U	1	0	1	EtherCAT®, position, velocity and acceleration (1...30 magnet(s))
U	1	1	1	EtherCAT®, position, velocity and acceleration internal linearization (1...30 magnet(s))

NOTICE

- Specify number of magnets for your application and order the magnets separately.
- The number of magnets is limited by the stroke length. The minimum allowed distance between magnets (i.e. front face of one to the front face of the next one) is 75 mm (3 in.).
- Use magnets of the same type for multi-position measurement.
- If the option for internal linearization (U111) in **h** "Output" is chosen, select a suitable magnet.
- The internal linearization (U111) in **h** "Output" is not available with the flexible sensing element **F** in **c** "Mechanical options".

DELIVERY



- RH5-B:**
- Base unit (without flange & rod assembly)
 - 3 × socket screws M4×59

RH5-J/-M/-S/-T:

- Sensor
 - O-ring
- Accessories have to be ordered separately.

Manuals, Software & 3D Models available at:
www.temposonics.com

GLOSSARY

D

Distributed Clock

EtherCAT® uses a logical network of **Distributed Clocks (DC)** to synchronize the time on all local bus devices on the network. The EtherCAT® master usually selects the first Distributed Clock capable slave device as a Reference Clock, and then maintains a precise mapping of frame delays for all other slave devices in order to adjust their time to match the system time.

E

ESI

The properties and functions of an EtherCAT® device are described in an ESI file (**EtherCAT® Slave Information**). The XML-based ESI file contains all relevant data that are important for the implementation of the device in the controller as well as for data exchange during operation. The ESI file of the R-Series V EtherCAT® is available on the homepage www.temposonics.com.

EtherCAT®

EtherCAT® (**Ethernet for Control Automation Technology**) is an Industrial Ethernet interface and is managed by the **EtherCAT® Technology Group (ETG)**. The R-Series V EtherCAT® and its corresponding ESI file are certified by the ETG.

Extrapolation

The native measurement cycle time of a sensor increases with the stroke length. With extrapolation, the sensor is able to report data faster than the native cycle time, independent of the stroke length of the sensor. Without extrapolation, if data is requested faster than the native cycle time, the last measured value is repeated.

I

Internal Linearization

The internal linearization offers an improved linearity for an overall higher accuracy of the position measurement. The internal linearization is set for the sensor during production.

M

Multi-position measurement

During the measurement cycle, the positions of every magnet on the sensor are simultaneously reported. The velocity and acceleration are continuously calculated based on these changing position values as the magnets are moved.

UNITED STATES
Temposonics, LLC
Americas & APAC Region
3001 Sheldon Drive
Cary, N.C. 27513
Phone: +1 919 677-0100
E-mail: info.us@temposonics.com

GERMANY
Temposonics
GmbH & Co. KG
EMEA Region & India
Auf dem Schüffel 9
58513 Lüdenscheid
Phone: +49 2351 9587-0
E-mail: info.de@temposonics.com

ITALY
Branch Office
Phone: +39 030 988 3819
E-mail: info.it@temposonics.com

FRANCE
Branch Office
Phone: +33 6 14 060 728
E-mail: info.fr@temposonics.com

UK
Branch Office
Phone: +44 79 21 83 05 86
E-mail: info.uk@temposonics.com

SCANDINAVIA
Branch Office
Phone: +46 70 29 91 281
E-mail: info.sca@temposonics.com

CHINA
Branch Office
Phone: +86 21 3405 7850
E-mail: info.cn@temposonics.com

JAPAN
Branch Office
Phone: +81 3 6416 1063
E-mail: info.jp@temposonics.com

Document Part Number:
552055 Revision B (EN) 12/2024



EtherCAT
Conformance tested

temposonics.com