

Data Sheet

R-Series V RM5 POWERLINK

Magnetostrictive Linear Position Sensors

- Super shield housing with IP68/IP69 against ingress of dust and water
- Minimum position resolution 0.5 μm
- Position and velocity measurements for up to 30 magnets



V
THE NEW GENERATION

MEASURING TECHNOLOGY

The absolute, linear position sensors provided by Temposonics rely on the company's proprietary magnetostrictive technology, which can determine position with a high level of precision and robustness. Each Temposonics® position sensor consists of a ferromagnetic waveguide, a position magnet, a strain pulse converter and supporting electronics. The magnet, connected to the object in motion in the application, generates a magnetic field at its location on the waveguide. A short current pulse is applied to the waveguide. This creates a momentary radial magnetic field and torsional strain on the waveguide. The momentary interaction of the magnetic fields releases a torsional strain pulse that propagates the length of the waveguide. When the ultrasonic wave reaches the beginning of the waveguide it is converted into an electrical signal. Since the speed of the ultrasonic wave in the waveguide is precisely known, the time required to receive the return signal can be converted into a linear position measurement with both high accuracy and repeatability.

R-SERIES V RM5 POWERLINK

The Temposonics® R-Series V brings very powerful sensor performance to meet the many demands of your application. The RM5 sensor is the version of the RH5 rod sensor in a protective housing (super shield housing). The main advantages of the RM5 are:



Protection against corrosion

The housing made of high-quality stainless steel offers very good corrosion resistance. Thus, you can use the R-Series V also in aggressive environments.

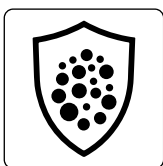

Protection against ingress of dust

The housing protects the internal sensor against penetration of dust. This maintains the sensor's performance even in heavy dust.

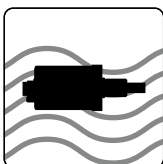

Protection against ingress of water

The housing protects the internal sensor when submerged. This allows you to use the R-Series V even under water.

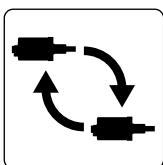

Easy and fast replacement

If necessary, the sensor inside the housing can be replaced easily and fast. This saves time and downtime costs.

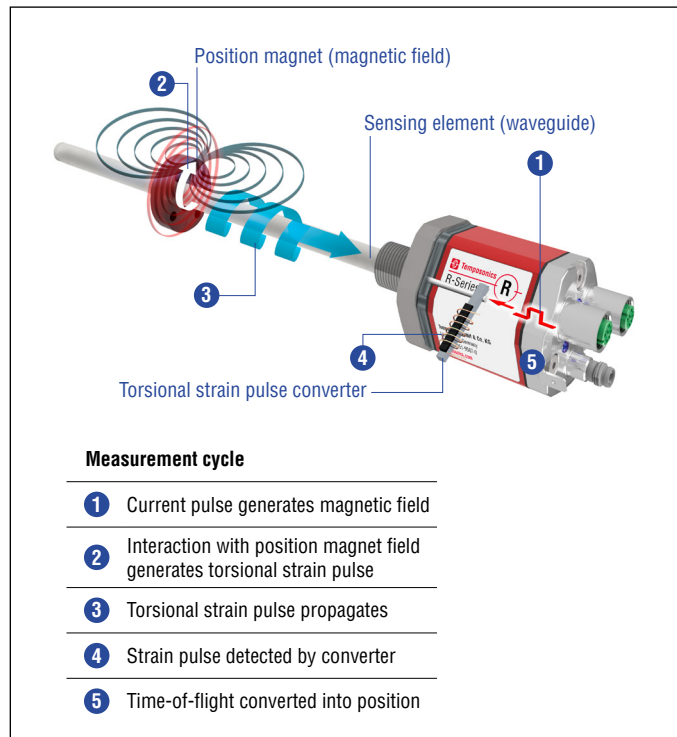
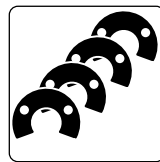

Fig. 1: Time-of-flight based magnetostrictive position sensing principle

In addition the R-Series V POWERLINK scores with the following features:



30 positions simultaneously

The R-Series V POWERLINK can detect and report the position and velocity of up to 30 magnets simultaneously.



R-Series V POWERLINK

In addition to the measured position value via the POWERLINK protocol further data about the current sensor status, such as the total distance travelled, the internal temperature and the total operating hours, can be displayed for diagnostic purposes.

All settings under control with the smart assistants for the R-Series V

The TempoLink® and the TempoGate® smart assistants support you in setup and diagnostics of the R-Series V. For more information of these assistants please see the data sheets:

- TempoLink® smart assistant (Document part number: [552070](#))
- TempoGate® smart assistant (Document part number: [552110](#))



TECHNICAL DATA

| Output | | | | | | |
|----------------------------------|---|-------------|---------------|---------------|-----------|-----------|
| Interface | Ethernet POWERLINK | | | | | |
| Data protocol | POWERLINK V2 | | | | | |
| Measured value | Position, velocity/option: Simultaneous multi-position and multi-velocity measurements up to 30 magnets | | | | | |
| Measurement parameters | | | | | | |
| Resolution: Position | 0.5...100 µm (selectable) | | | | | |
| Cycle time ¹ | Stroke length | ≤ 50 mm | ≤ 715 mm | ≤ 2000 mm | ≤ 4675 mm | ≤ 7615 mm |
| | Cycle time | 250 µs | 500 µs | 1000 µs | 2000 µs | 3200 µs |
| Linearity deviation ² | Stroke length | ≤ 500 mm | > 500 mm | | | |
| | Linearity deviation | ≤ ±50 µm | < 0.01 % F.S. | | | |
| | Optional internal linearization: Linearity tolerance (applies for the first magnet for multi-position measurement) | | | | | |
| | Stroke length | 25...300 mm | 300...600 mm | 600...1200 mm | | |
| | typical | ± 15 µm | ± 20 µm | ± 25 µm | | |
| | maximum | ± 25 µm | ± 30 µm | ± 50 µm | | |
| Repeatability | < ±0.001 % F.S. (minimum ±2.5 µm) typical | | | | | |
| Hysteresis | < 4 µm typical | | | | | |
| Temperature coefficient | < 15 ppm/K typical | | | | | |
| Operating conditions | | | | | | |
| Operating temperature | -40...+85 °C (-40...+185 °F) | | | | | |
| Humidity | 100 % relative humidity, no condensation | | | | | |
| Ingress protection | IP68 (3 m/180 d)/IP69 | | | | | |
| Shock test | 100 g/6 ms, IEC standard 60068-2-27 | | | | | |
| Vibration test | 10 g/10...2000 Hz, IEC 60068-2-6 (excluding resonant frequencies) | | | | | |
| EMC test | Electromagnetic emission according to EN 61000-6-3 | | | | | |
| | Electromagnetic immunity according to EN 61000-6-2 | | | | | |
| | The RM5 sensors fulfill the requirements of the EMC directives 2014/30/EU, UKSI 2016 No. 1091 and TR CU 020/2011 | | | | | |
| Operating pressure | 350 bar (5076 psi)/700 bar (10,153 psi) peak (at 10 × 1 min) for sensor rod | | | | | |
| Magnet movement velocity | Any | | | | | |
| Design/Material | | | | | | |
| Sensor electronics housing | Stainless steel 1.4404 (AISI 316L) | | | | | |
| Sensor flange | Stainless steel 1.4404 (AISI 316L) | | | | | |
| Sensor rod | Stainless steel 1.4404 (AISI 316L) | | | | | |
| RoHS compliance | The used materials are compliant with the requirements of EU Directive 2011/65/EU and EU Regulation 2015/863 as well as UKSI 2022 No. 622 | | | | | |
| Stroke length | 25...7615 mm (1...299.8 in.) | | | | | |
| Mechanical mounting | | | | | | |
| Mounting position | Any | | | | | |
| Mounting instruction | Please consult the technical drawings and the operation manual (document number: 552010) | | | | | |
| Electrical connection | | | | | | |
| Connection type | 2 × cable with M12 female connector (D-coded), 1 × cable | | | | | |
| Operating voltage | +12...30 VDC ±20 % (9.6...36 VDC); The RM5 sensors must be power supplied via an external Class 2 power source in accordance with the UL approval | | | | | |
| Power consumption | Less than 4 W typical | | | | | |
| Dielectric strength | 500 VDC (DC ground to machine ground) | | | | | |
| Polarity protection | Up to -36 VDC | | | | | |
| Overvoltage protection | Up to 36 VDC | | | | | |

1/ Minimum cycle time for multi-position measurements (number of magnets ≥ 2): 400 µs

2/ With position magnet # 251 416-2

TECHNICAL DRAWING

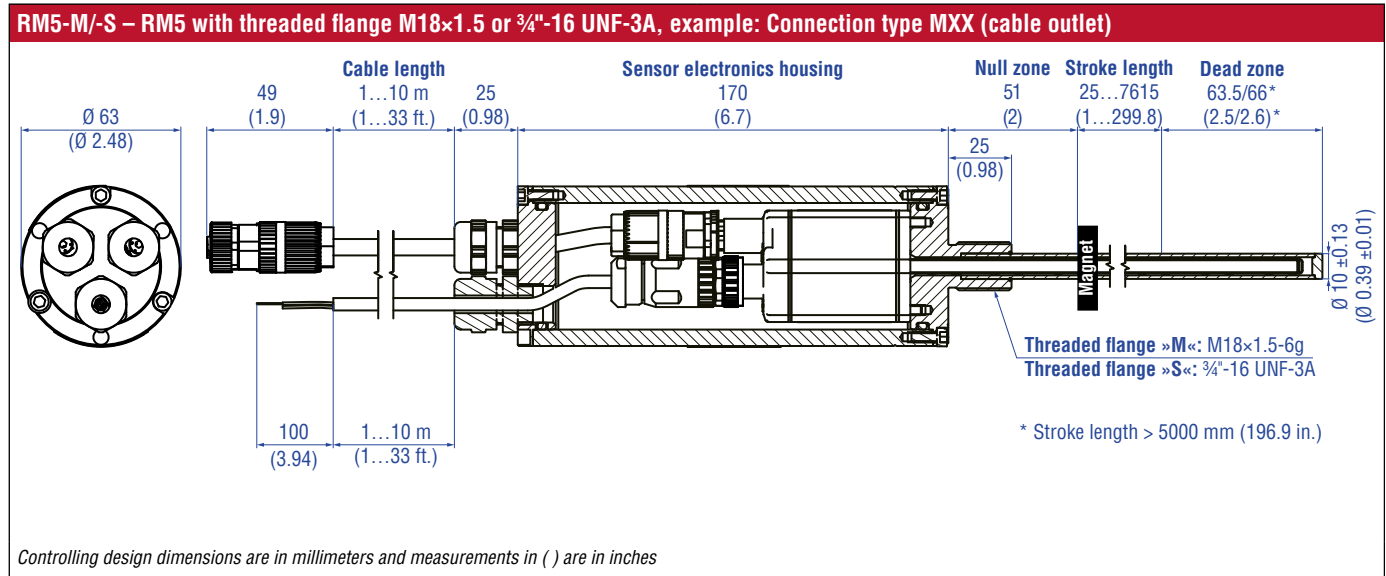

Fig. 2: Temposonics® RM5 with ring magnet

STRUCTURE

The RM5 POWERLINK consists of (Fig. 3)

- 1 Super shield housing
- 2 R-Series V sensor with connector outlet (connection type D58)
- 3 Cable for direct connection to the controller (connection type MXX)

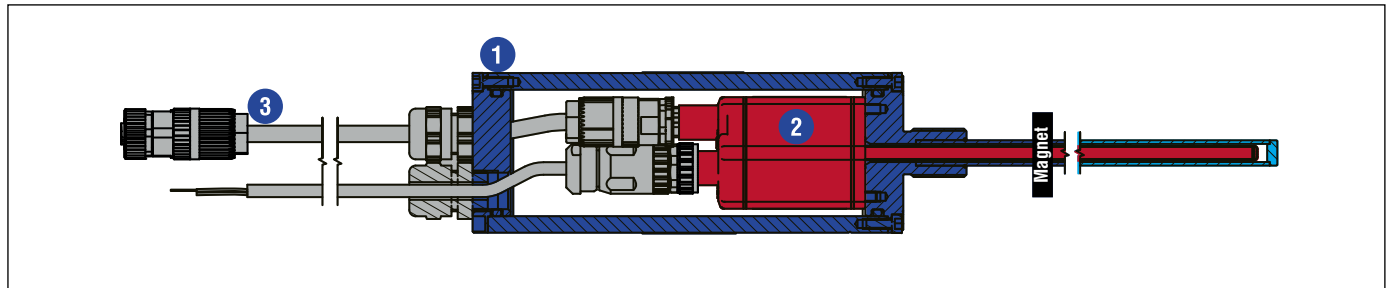

Fig. 3: Structure of RM5 POWERLINK

CONNECTOR WIRING



| MXX | | |
|---|--------------|-----------------------------|
| Port 1 – Signal | | |
| M12 female connector (D-coded) | Pin | Function |
|  <p>View on sensor</p> | 1 | Tx (+) |
| | 2 | Rx (+) |
| | 3 | Tx (-) |
| | 4 | Rx (-) |
| Port 2 – Signal | | |
| M12 female connector (D-coded) | Pin | Function |
|  <p>View on sensor</p> | 1 | Tx (+) |
| | 2 | Rx (+) |
| | 3 | Tx (-) |
| | 4 | Rx (-) |
| Power supply | | |
| Cable | Color | Function |
|  <p>View on sensor</p> | BN | +12...30 VDC ($\pm 20\%$) |
| | WH | Not connected |
| | BU | DC Ground (0 V) |
| | BK | Not connected |

Fig. 4: Connector wiring MXX

FREQUENTLY ORDERED ACCESSORIES – Additional options available in our [Accessories Catalog](#) 551444

| Position magnets | | | |
|---|--|--|--|
| | | | |
| <p>U-magnet OD33 Part no. 251 416-2</p> <p>Material: PA ferrite GF20 Weight: Approx. 11 g Surface pressure: Max. 40 N/mm² Fastening torque for M4 screws: 1 Nm Operating temperature: -40...+105 °C (-40...+221 °F)</p> <p>Marked version for sensors with internal linearization: Part no. 254 226</p> | <p>Ring magnet OD33 Part no. 201 542-2</p> <p>Material: PA ferrite GF20 Weight: Approx. 14 g Surface pressure: Max. 40 N/mm² Fastening torque for M4 screws: 1 Nm Operating temperature: -40...+105 °C (-40...+221 °F)</p> <p>Marked version for sensors with internal linearization: Part no. 253 620</p> | <p>Ring magnet OD25.4 Part no. 400 533</p> <p>Material: PA ferrite Weight: Approx. 10 g Surface pressure: Max. 40 N/mm² Operating temperature: -40...+105 °C (-40...+221 °F)</p> <p>Marked version for sensors with internal linearization: Part no. 253 621</p> | <p>Ring magnet Part no. 402 316</p> <p>Material: PA ferrite coated Weight: Approx. 13 g Surface pressure: Max. 20 N/mm² Operating temperature: -40...+100 °C (-40...+212 °F)</p> |

| Position magnet | Magnet spacer | O-rings | |
|--|--|---|---|
| | | | |
| <p>Block magnet L Part no. 403 448</p> <p>Material: Plastic carrier with neodymium magnet Weight: Approx. 20 g Fastening torque for M4 screws: 1 Nm Operating temperature: -40...+75 °C (-40...+167 °F)</p> <p>This magnet may influence the sensor performance specifications for some applications.</p> | <p>Magnet spacer Part no. 400 633</p> <p>Material: Aluminum Weight: Approx. 5 g Surface pressure: Max. 20 N/mm² Fastening torque for M4 screws: 1 Nm</p> | <p>O-ring for threaded flange M18×1.5-6g Part no. 401 133</p> <p>Material: Fluoroelastomer Durometer: 75 ±5 Shore A Operating temperature: -40...+204 °C (-40...+400 °F)</p> | <p>O-ring for threaded flange ¾"-16 UNF-3A Part no. 560 315</p> <p>Material: Fluoroelastomer Durometer: 75 ±5 Shore A Operating temperature: -40...+204 °C (-40...+400 °F)</p> |

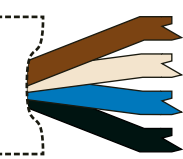
| Mounting accessories | | |
|---|---|---|
| | | |
| <p>Hex jam nut M18×1.5-6g Part no. 500 018</p> <p>Material: Steel, zinc plated</p> | <p>Hex jam nut ¾"-16 UNF-3A Part no. 500 015</p> <p>Material: Steel, zinc plated</p> | <p>Fixing clip Part no. 561 481</p> <p>Application: Used to secure sensor rods (Ø 10 mm (Ø 0.39 in.)) when using an U-magnet or block magnet Material: Brass, non-magnetic</p> |

Cable connectors* – Signal

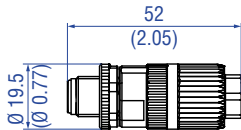

M12 D-coded male connector (4 pin), straight
Part no. 370 523

Material: Zinc nickel-plated
Termination: Insulation-displacement
Cable Ø: 6...7.2 mm (0.2...0.28 in.)
Wire: 24 AWG – 22 AWG
Operating temperature:
–25...+85 °C (–13...+185 °F)
Ingress protection: IP65 / IP67 (correctly fitted)
Fastening torque: 0.6 Nm

Cable connectors* – Power

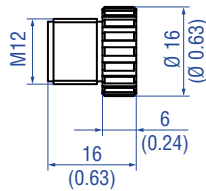

M12 connector end cap
Part no. 370 537

Female connectors M12 should be covered by this protective cap
Material: Brass nickel-plated
Ingress protection: IP67 (correctly fitted)
Fastening torque: 0.39...0.49 Nm

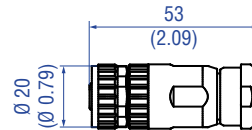

M12 A-coded female connector (4 pin/5 pin), straight
Part no. 370 677

Material: GD-Zn, Ni
Termination: Screw
Contact insert: CuZn
Cable Ø: 4...8 mm (0.16...0.31 in.)
Wire: max. 1.5 mm² (16 AWG)
Operating temperature:
–30...+85 °C (–22...+185 °F)
Ingress protection: IP67 (correctly fitted)
Fastening torque: 0.6 Nm

Cables

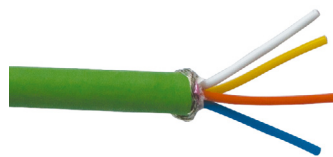

PUR signal cable
Part no. 530 125

Material: PUR jacket; green
Features: Cat 5, highly flexible, halogen free, suitable for drag chains, mostly oil & flame resistant
Cable Ø: 6.5 mm (0.26 in.)
Cross section: 2 × 2 × 0.35 mm² (22 AWG)
Bending radius: 6 × D (fixed installation)
Operating temperature:
–20...+60 °C (–4...+140 °F)



PVC power cable
Part no. 530 108

Material: PVC jacket; gray
Features: Shielded, flexible, mostly flame resistant
Cable Ø: 4.9 mm (0.19 in.)
Cross section: 3 × 0.34 mm²
Bending radius: 5 × D (fixed installation)
Operating temperature:
–30...+80 °C (–22...+176 °F)

Cable sets



Signal cable with M12 D-coded male connector (4 pin), straight – M12 D-coded, male connector (4 pin), straight
Part no. 530 064

Material: PUR jacket; green
Feature: Cat 5e
Cable length: 5 m (16.4 ft)
Cable Ø: 6.5 mm (0.26 in.)
Ingress protection: IP65, IP67, IP68 (correctly fitted)
Operating temperature:
–30...+70 °C (–22...+158 °F)





Signal cable with M12 D-coded male connector (4 pin), straight – RJ45 male connector, straight
Part no. 530 065

Material: PUR jacket; green
Feature: Cat 5e
Cable length: 5 m (16.4 ft)
Cable Ø: 6.5 mm (0.26 in.)
Ingress protection M12 connector: IP67 (correctly fitted)
Ingress protection RJ45 connector: IP20 (correctly fitted)
Operating temperature:
–30...+70 °C (–22...+158 °F)

*/ Follow the manufacturer's mounting instructions
Controlling design dimensions are in millimeters and measurements in () are in inches
Color of connectors and cable jacket may change. Color codes for the individual wires and technical properties remain unchanged.

Temposonics® R-Series V RM5 POWERLINK

Data Sheet

| Cable sets | Programming tools | |
|---|--|---|
|  |  |  |
| <p>Power cable with M12 A-coded female connector (5 pin), straight – pigtail Part no. 370 673</p> | <p>TempoLink® kit for Temposonics® R-Series V Part no. TL-1-0-EM08 (D56) Part no. TL-1-0-EM12 (D58)</p> | <p>TempoGate® smart assistant for Temposonics® R-Series V Part no. TG-C-0-Dxx (xx indicates the number of R-Series V sensors that can be connected (even numbers only))</p> |
| <p>Material: PUR jacket; black Feature: Shielded Cable length: 5 m (16.4 ft) Ingress protection: IP67 (correctly fitted) Operating temperature: -25...+80 °C (-13...+176 °F)</p> | <ul style="list-style-type: none"> • Connect wirelessly via Wi-Fi enabled device or via USB with the diagnostic tool • Simple connectivity to the sensor via 24 VDC power line (permissible cable length: 30 m) • User friendly interface for mobile devices and desktop computers • See data sheet "TempoLink® smart assistant" (document part no.: 552070) for further information | <ul style="list-style-type: none"> • OPC UA server for diagnostics of the R-Series V • For installation in the control cabinet • Connection via LAN and Wi-Fi • See data sheet "TempoGate® smart assistant" document part no.: 552110 for further information |

Color of connectors and cable jacket may change. Color codes for the individual wires and technical properties remain unchanged.

ORDER CODE

| | | | | | | | | | | | | | | | | | | | |
|---|---|---|---|---|---|---|---|---|----|----|----|----|----|----|----|----|----|----|----|
| 1 | 2 | 3 | 4 | 5 | 6 | 7 | 8 | 9 | 10 | 11 | 12 | 13 | 14 | 15 | 16 | 17 | 18 | 19 | 20 |
| R | M | 5 | | A | | | | | | | | | | | 1 | U | 3 | | 1 |
| a | | | b | c | d | | | | | e | f | | | g | h | | | | |

| | |
|----------|----------------------|
| a | Sensor model |
| R M 5 | Super shield housing |

| | |
|----------|---|
| b | Design |
| M | Threaded flange M18×1.5-6g (standard) |
| S | Threaded flange ¾"-16 UNF-3A (standard) |

| | |
|----------|---------------------------|
| c | Mechanical options |
| A | Standard |

| | |
|-----------|----------------------|
| d | Stroke length |
| X X X X M | 0025...7615 mm |

| Standard stroke length (mm) | Ordering steps |
|-----------------------------|----------------|
| 25... 500 mm | 5 mm |
| 500... 750 mm | 10 mm |
| 750...1000 mm | 25 mm |
| 1000...2500 mm | 50 mm |
| 2500...5000 mm | 100 mm |
| 5000...7615 mm | 250 mm |

| | |
|-----------|-------------------|
| X X X X U | 001.0...299.8 in. |
|-----------|-------------------|

| Standard stroke length (in.) | Ordering steps |
|------------------------------|----------------|
| 1... 20 in. | 0.2 in. |
| 20... 30 in. | 0.4 in. |
| 30... 40 in. | 1.0 in. |
| 40...100 in. | 2.0 in. |
| 100...200 in. | 4.0 in. |
| 200...299.8 in. | 10.0 in. |

Non-standard stroke lengths are available; must be encoded in 5 mm/0.1 in. increments.

| | |
|----------|--|
| e | Number of magnets |
| X X | 01...30 position(s) (1...30 magnet(s)) |

| | |
|--|---|
| f | Connection type |
| M X X | 2 × XX m/ft. PUR cable (part no. 530 125) for data lines with M12 female connector (part no. 370 830) and 1 × XX m/ft. PVC cable (part no. 530 108) for power supply M01...M10 (1...10 m/1...33 ft.) See "Frequently ordered accessories" for cable & connector specifications |
| Encode in meters if using metric stroke length Encode in feet if using US customary stroke length | |



| | |
|----------|---------------|
| g | System |
| 1 | Standard |

| | |
|----------|---|
| h | Output |
| U 3 0 1 | POWERLINK, position and velocity (1...30 magnet(s)) |
| U 3 1 1 | POWERLINK, position and velocity, internal linearization (1...30 magnet(s)) |

NOTICE

- Specify the number of magnets for your application and order the magnets separately.
- The number of magnets is limited by the stroke length. The minimum allowed distance between magnets (i.e. front face of one to the front face of the next one) is 75 mm (3 in.).
- Use magnets of the same type for multi-position measurement.
- If the option for internal linearization (U311) in "Output" is chosen, select a suitable magnet.

DELIVERY

-  Sensor
 -  O-ring
- Accessories have to be ordered separately.

Manuals, Software & 3D Models available at:
www.temposonics.com

GLOSSARY

E

Extrapolation

The native measurement cycle time of a sensor increases with the stroke length. With extrapolation, the sensor is able to report data faster than the native cycle time, independent of the stroke length of the sensor. Without extrapolation, if data is requested faster than the native cycle time, the last measured value is repeated.

I

Internal Linearization

The internal linearization offers an improved linearity for an overall higher accuracy of the position measurement. The internal linearization is set for the sensor during production.

M

Multi-position measurement

During the measurement cycle, the positions of every magnet on the sensor are simultaneously reported. The velocity is continuously calculated based on these changing position values as the magnets are moved.

N

Node ID

The addressing of the devices in a POWERLINK network is done via the node ID. Each node ID only exists once in a network. It can have a value between 1 and 240 (while 240 is reserved for the Managing Node). Meaning that a POWERLINK network can comprise up to 240 devices. With the R-Series V POWERLINK, the node ID (delivered with node ID 1) can be set via the TempoLink smart assistant, for example.

P

POWERLINK

POWERLINK is an Industrial Ethernet interface and is managed by the Ethernet POWERLINK Standardization Group (EPSG). The R-Series V POWERLINK and its corresponding XDD file are certified by the EPSG.

S

Synchronization mode

R-Series V POWERLINK supports synchronization mode. The synchronization mode enables clock-synchronous data exchange between sensor and control. The synchronous measurement is an essential requirement for motion-controlled applications

X

XDD file

The properties and functions of a POWERLINK device are described in an XDD file (XML Device Description). The XML-based XDD file contains all relevant data that are important for the implementation of the device in the controller as well as for data exchange during operation. The XDD file of the R-Series V POWERLINK is available on the homepage www.temposonics.com.

UNITED STATES
Temposonics, LLC
Americas & APAC Region
3001 Sheldon Drive
Cary, N.C. 27513
Phone: +1 919 677-0100
E-mail: info.us@temposonics.com

GERMANY
Temposonics
GmbH & Co. KG
EMEA Region & India
Auf dem Schüffel 9
58513 Lüdenscheid
Phone: +49 2351 9587-0
E-mail: info.de@temposonics.com

ITALY
Branch Office
Phone: +39 030 988 3819
E-mail: info.it@temposonics.com

FRANCE
Branch Office
Phone: +33 6 14 060 728
E-mail: info.fr@temposonics.com

UK
Branch Office
Phone: +44 79 21 83 05 86
E-mail: info.uk@temposonics.com

SCANDINAVIA
Branch Office
Phone: +46 70 29 91 281
E-mail: info.sca@temposonics.com

CHINA
Branch Office
Phone: +86 21 3405 7850
E-mail: info.cn@temposonics.com

JAPAN
Branch Office
Phone: +81 3 6416 1063
E-mail: info.jp@temposonics.com

Document Part Number:
552117 Revision A (EN) 10/2024



ETHERNET 
POWERLINK
certified product

temposonics.com