

## Data Sheet

# R-Series V RFV PROFINET

## Magnetostrictive Linear Position Sensors

- Flexible sensor rod
- Stroke length up to 20 m
- Field adjustments and diagnostics using the new TempoLink® smart assistant



**V**  
THE NEW GENERATION

## MEASURING TECHNOLOGY

The absolute, linear position sensors provided by Temposonics rely on the company's proprietary magnetostrictive technology, which can determine position with a high level of precision and robustness. Each Temposonics position sensor consists of a ferromagnetic waveguide, a position magnet, a strain pulse converter and a supporting electronics. The magnet, connected to the object in motion in the application, generates a magnetic field at its location on the waveguide. A short current pulse is applied to the waveguide. This creates a momentary radial magnetic field and torsional strain on the waveguide. The momentary interaction of the magnetic fields releases a torsional strain pulse that propagates the length of the waveguide. When the ultrasonic wave reaches the beginning of the waveguide it is converted into an electrical signal. Since the speed of the ultrasonic wave in the waveguide is precisely known, the time required to receive the return signal can be converted into a linear position measurement with both high accuracy and repeatability.

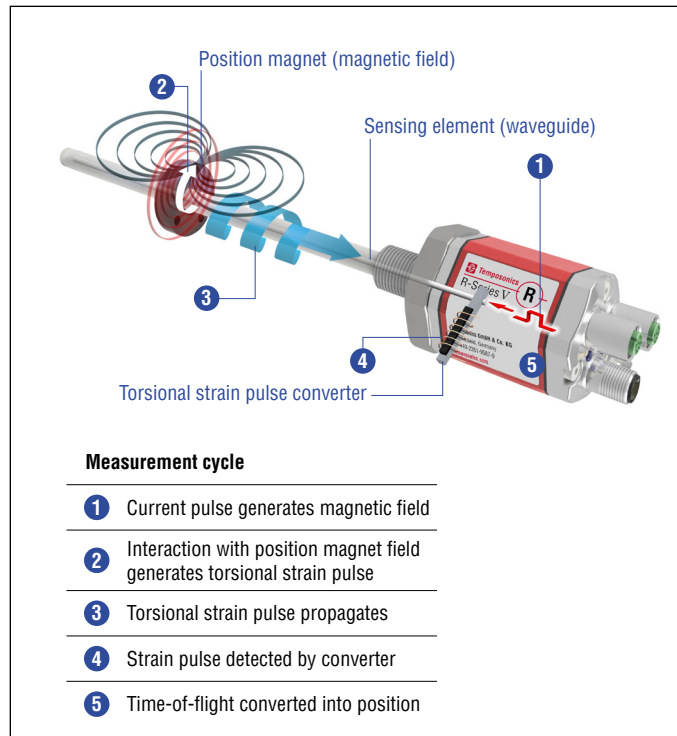
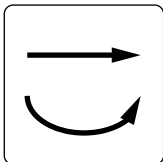

Fig. 1: Time-of-flight based magnetostrictive position sensing principle

## R-SERIES V RFV PROFINET

The Temposonics® R-Series V brings very powerful sensor performance to meet the many demands of your application. The RFV sensor is the R-Series V with flexible rod. The main advantages of the flexible rod are:



**Straight and curved line**  
The flexible measuring rod enables position measurement on straight and also curved line.

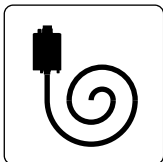

**Compact for transport and storage**  
For transport and storage, the RFV sensor can be coiled up. This saves costs and space.

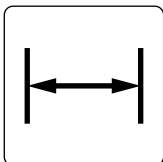

**Installation with little space**  
Due to the bendable rod, the RFV sensor can be installed even if only little space is available.

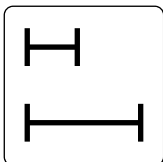

**Large stroke length range**  
The sensor is available with stroke lengths from 150 mm to 20,000 mm and thus can be used in both short and long distance applications.

In addition the R-Series V PROFINET scores with the following features:

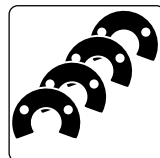

**30 positions simultaneously**  
The R-Series V PROFINET can detect and report the position and velocity of up to 30 magnets simultaneously.

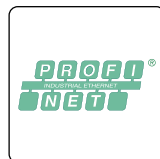

**R-Series V PROFINET**  
In addition to the measured position value via the PROFINET protocol further data about the current sensor status, such as the total distance travelled, the internal temperature and the total operating hours, can be displayed for diagnostic purposes.

**All settings under control with the sensor assistants for the R-Series V**  
The TempoLink® and the TempoGate® smart assistants support you in setup and diagnostics of the R-Series V. For more information of these assistants please see the data sheets:

- TempoLink® smart assistant  
([Document part number: 552070](#))
- TempoGate® smart assistant  
([Document part number: 552110](#))



## TECHNICAL DATA

Output						
Interface	PROFINET RT PROFINET IRT version 2.3					
Data protocol	Linear profile and encoder profile V4.2					
Data transmission rate	100 MBit/s (maximum)					
Measured value	Position, velocity/option: Simultaneous multi-position and multi-velocity measurements up to 30 magnets					
Measurement parameters						
Resolution: Position	0.5...100 µm (selectable)					
Cycle time	Stroke length	≤ 715 mm	≤ 2000 mm	≤ 4675 mm	≤ 10,000 mm	≤ 20,000 mm
	Cycle time	500 µs	1000 µs	2000 µs	4000 µs	8000 µs
Linearity deviation <sup>1</sup>	< ±0.02 % F.S. (minimum ±100 µm)					
Repeatability	< ±0.001 % F.S. (minimum ±2.5 µm) typical					
Hysteresis	< 4 µm typical					
Temperature coefficient	< 15 ppm/K typical					
Operating conditions						
Operating temperature	-40...+85 °C (-40...+185 °F)					
Humidity	90 % relative humidity, no condensation					
Ingress protection	IP30 (IP65 rating only for professional mounted guide pipe and if mating connectors are correctly fitted)					
Shock test	100 g/6 ms, IEC standard 60068-2-27					
Vibration test	5 g/10...2000 Hz, IEC standard 60068-2-6 (excluding resonant frequencies)					
EMC test	Electromagnetic emission according to EN 61000-6-3					
	Electromagnetic immunity according to EN 61000-6-2 The RFV sensors fulfill the requirements of the EMC directives 2014/30/EU, UKSI 2016 No. 1091 and TR CU 020/2011 under the condition of an EMC compliant installation <sup>2</sup>					
Magnet movement velocity	Any					
Design/Material						
Sensor electronics housing	Aluminum (painted), zinc die cast					
Sensor flange	Stainless steel 1.4305 (AISI 303)					
Sensor rod	Stainless steel conduct with PTFE coating					
RoHS compliance	The used materials are compliant with the requirements of EU Directive 2011/65/EU and EU Regulation 2015/863 as well as UKSI 2022 No. 622					
Stroke length	150...20,000 mm (6...787 in.)					
Mechanical mounting						
Mounting position	Any					
Mounting instruction	Please consult the technical drawings on <a href="#">page 4</a> and the operation manual (document number: <a href="#">551973</a> )					
Electrical connection						
Connection type	2 × M12 female connectors (5 pin), 1 × M12 male connector (4 pin) or 2 × M12 female connectors (5 pin), 1 × M8 male connector (4 pin)					
Operating voltage	+12...30 VDC ±20 % (9.6...36 VDC)					
Power consumption	Less than 4 W typical					
Dielectric strength	500 VDC (DC ground to machine ground)					
Polarity protection	Up to -36 VDC					
Overvoltage protection	Up to 36 VDC					

1/ With position magnet # 251 416-2

2/ The flexible sensor element must be mounted in an appropriately shielded environment

## TECHNICAL DRAWING

### RFV-B – RFV base unit, example: Connection type D56 (connector outlet)

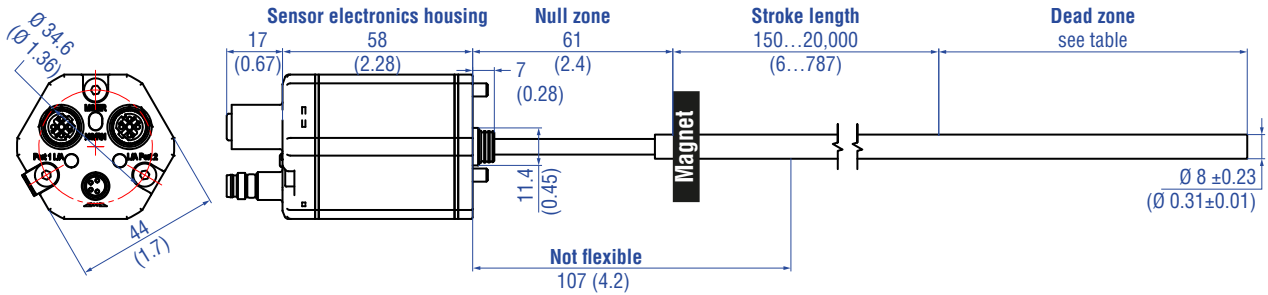

Stroke length	Tolerance of total length	Dead zone
Up to 7620 mm (300.00 in.)	+8 mm (0.31 in.)/-5 mm (0.20 in.)	94 mm (3.70 in.)
Up to 10,000 mm (393.70 in.)	+15 mm (0.59 in.)/-15 mm (0.59 in.)	100 mm (3.94 in.)
Up to 15,000 mm (590.55 in.)	+15 mm (0.59 in.)/-30 mm (1.18 in.)	120 mm (4.72 in.)
Up to 20,000 mm (787.00 in.)	+15 mm (0.59 in.)/-45 mm (1.77 in.)	140 mm (5.51 in.)

Note: Tolerance of total length has no influence on the stroke length.

### RFV-M/S – RFV with threaded flange M18×1.5-6g or 3/4"-16 UNF-3A, example: Connection type D58 (connector outlet)

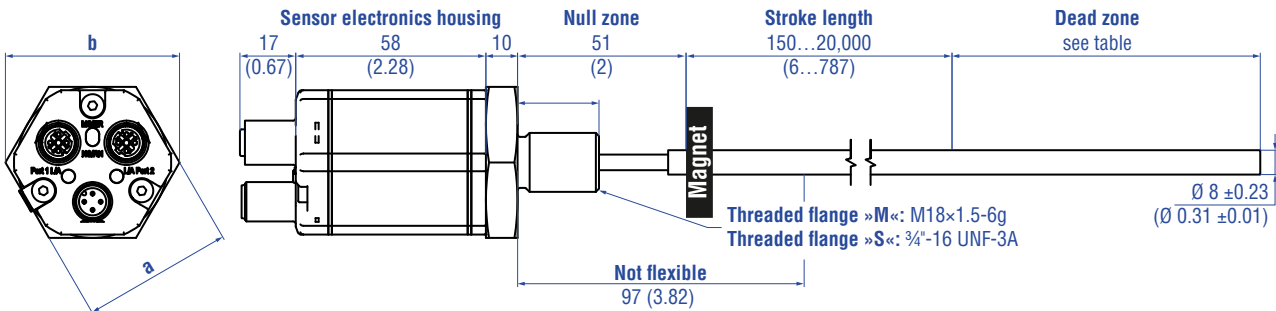

Threaded flange	a	b
»M«	A/F 46 (1.81)	53 (2.09)
»S«	A/F 44.5 (1.75)	51.3 (2.02)

Stroke length	Tolerance of total length	Dead zone
Up to 7620 mm (300.00 in.)	+8 mm (0.31 in.)/-5 mm (0.20 in.)	94 mm (3.70 in.)
Up to 10,000 mm (393.70 in.)	+15 mm (0.59 in.)/-15 mm (0.59 in.)	100 mm (3.94 in.)
Up to 15,000 mm (590.55 in.)	+15 mm (0.59 in.)/-30 mm (1.18 in.)	120 mm (4.72 in.)
Up to 20,000 mm (787.00 in.)	+15 mm (0.59 in.)/-45 mm (1.77 in.)	140 mm (5.51 in.)

Note: Tolerance of total length has no influence on the stroke length.

Controlling design dimensions are in millimeters and measurements in ( ) are in inches

Fig. 2: Temposonics® RFV with ring magnet

**CONNECTOR WIRING**



D58		
<b>Port 1 – Signal</b>		
<b>M12 female connector (D-coded)</b>	<b>Pin</b>	<b>Function</b>
 <p>View on sensor</p>	1	Tx (+)
	2	Rx (+)
	3	Tx (-)
	4	Rx (-)
<b>Port 2 – Signal</b>		
<b>M12 female connector (D-coded)</b>	<b>Pin</b>	<b>Function</b>
 <p>View on sensor</p>	1	Tx (+)
	2	Rx (+)
	3	Tx (-)
	4	Rx (-)
<b>Power supply</b>		
<b>M12 male connector (A-coded)</b>	<b>Pin</b>	<b>Function</b>
 <p>View on sensor</p>	1	+12...30 VDC (±20 %)
	2	Not connected
	3	DC Ground (0 V)
	4	Not connected

Fig. 3: Connector wiring D58



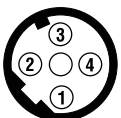

D56		
<b>Port 1 – Signal</b>		
<b>M12 female connector (D-coded)</b>	<b>Pin</b>	<b>Function</b>
 <p>View on sensor</p>	1	Tx (+)
	2	Rx (+)
	3	Tx (-)
	4	Rx (-)
<b>Port 2 – Signal</b>		
<b>M12 female connector (D-coded)</b>	<b>Pin</b>	<b>Function</b>
 <p>View on sensor</p>	1	Tx (+)
	2	Rx (+)
	3	Tx (-)
	4	Rx (-)
<b>Power supply</b>		
<b>M8 male connector</b>	<b>Pin</b>	<b>Function</b>
 <p>View on sensor</p>	1	+12...30 VDC (±20 %)
	2	Not connected
	3	DC Ground (0 V)
	4	Not connected

Fig. 4: Connector wiring D56

**FREQUENTLY ORDERED ACCESSORIES** – Additional options available in our [Accessories Catalog](#) 551444

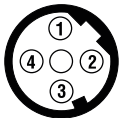
Position magnets			
			
<p><b>U-magnet OD33</b> Part no. 251 416-2</p>	<p><b>Ring magnet OD60</b> Part no. MT0162</p>	<p><b>Ring magnet</b> Part no. 402 316</p>	<p><b>U-magnet OD63.5</b> Part no. 201 553</p>
<p>Material: PA ferrite GF20 Weight: Approx. 11 g Surface pressure: Max. 40 N/mm<sup>2</sup> Fastening torque for M4 screws: 1 Nm Operating temperature: -40...+105 °C (-40...+221 °F)</p>	<p>Material: AlCuMgPb, magnets compound-filled Weight: Approx. 90 g Surface pressure: Max. 20 N/mm<sup>2</sup> Fastening torque for M4 screws: 1 Nm Operating temperature: -40...+75 °C (-40...+167 °F)</p>	<p>Material: PA ferrite coated Weight: Approx. 13 g Surface pressure: Max. 20 N/mm<sup>2</sup> Operating temperature: -40...+100 °C (-40...+212 °F)</p>	<p>Material: PA 66-GF30, magnets compound-filled Weight: Approx. 26 g Surface pressure: 20 N/mm<sup>2</sup> Fastening torque for M4 screws: 1 Nm Operating temperature: -40...+75 °C (-40...+167 °F)</p>
O-rings		Mounting accessories	
			
<p><b>O-ring for threaded flange M18x1.5-6g</b> Part no. 401 133</p>	<p><b>O-ring for threaded flange 3/4"-16 UNF-3A</b> Part no. 560 315</p>	<p><b>Hex jam nut M18x1.5-6g</b> Part no. 500 018</p>	<p><b>Hex jam nut 3/4"-16 UNF-3A</b> Part no. 500 015</p>
<p>Material: Fluoroelastomer Durometer: 75 ± 5 Shore A Operating temperature: -40...+204 °C (-40...+400 °F)</p>	<p>Material: Fluoroelastomer Durometer: 75 ± 5 Shore A Operating temperature: -40...+204 °C (-40...+400 °F)</p>	<p>Material: Steel, zinc plated</p>	<p>Material: Steel, zinc plated</p>
Mounting accessories			
			
<p><b>Threaded flange M18x1.5-6g</b> Part no. 404 874</p>	<p><b>Threaded flange 3/4"-16 UNF-3A</b> Part no. 404 875</p>		
<p>Material: Stainless steel 1.4305 (AISI 303)</p>	<p>Material: Stainless steel 1.4305 (AISI 303)</p>		

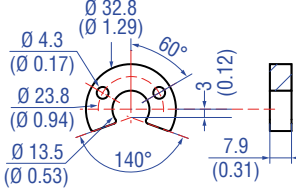
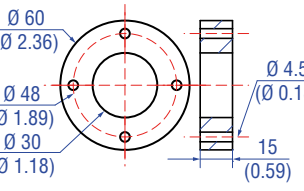
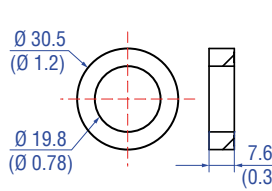
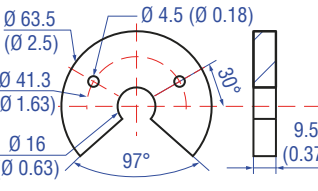
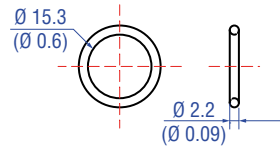
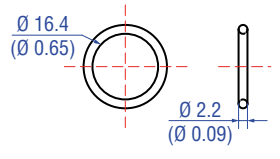
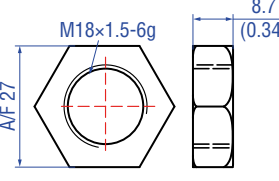
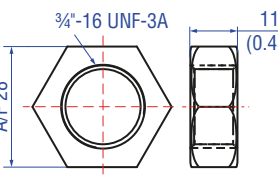
Controlling design dimensions are in millimeters and measurements in ( ) are in inches

**Mounting accessories**



**Pressure rod with threaded flange with flat-face (M18x1.5-6g) and O-ring**  
**HD [length mm: XXXX] M**  
**HD [length in.: XXX.X] U**

Pressure rod Ø: 12.7 mm (0.5 in.)  
 Length: 100...7500 mm (4...295 in.)  
 Operating pressure: 350 bar (5076 psi)  
 Material flange:  
 Stainless steel 1.4305 (AISI 303)  
 Material rod:  
 Stainless steel 1.4301 (AISI 304)



**Pressure rod with threaded flange with flat-face (3/4"-16 UNF-3A) and O-ring**  
**HL [length mm: XXXX] M**  
**HL [length in.: XXX.X] U**

Pressure rod Ø: 12.7 mm (0.5 in.)  
 Length: 100...7500 mm (4...295 in.)  
 Operating pressure: 350 bar (5076 psi)  
 Material flange:  
 Stainless steel 1.4305 (AISI 303)  
 Material rod:  
 Stainless steel 1.4301 (AISI 304)





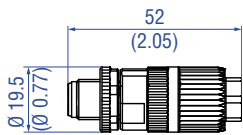
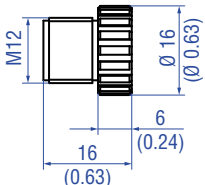
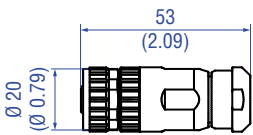
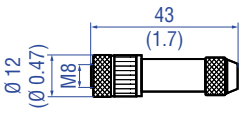

**Profile with flange**  
**HFP [length mm: XXXXX] M**  
**HFP [length in.: XXXX.X] U**

Length: Max. 20 000 mm (max. 787 in.)  
 Ingress protection: IP30  
 Material: Aluminum

**Cable connectors\* – Signal** **Cable connectors\* – Power**

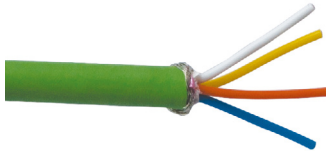
			
<p><b>M12 D-coded male connector (4 pin), straight</b> Part no. 370 523</p>	<p><b>M12 connector end cap</b> Part no. 370 537</p>	<p><b>M12 A-coded female connector (4 pin/5 pin), straight</b> Part no. 370 677</p>	<p><b>M8 female connector (4 pin), straight</b> Part no. 370 504</p>
<p>Material: Zinc nickel-plated Termination: Insulation-displacement Cable Ø: 5.5...7.2 mm (0.2...0.28 in.) Wire: 24 AWG – 22 AWG Operating temperature: –25...+85 °C (–13...+185 °F) Ingress protection: IP65 / IP67 (correctly fitted) Fastening torque: 0.6 Nm</p>	<p>Female connectors M12 should be covered by this protective cap Material: Brass nickel-plated Ingress protection: IP67 (correctly fitted) Fastening torque: 0.39...0.49 Nm</p>	<p>Material: GD-Zn, Ni Termination: Screw Contact insert: CuZn Cable Ø: 4...8 mm (0.16...0.31 in.) Wire: 1.5 mm<sup>2</sup> Operating temperature: –30...+85 °C (–22...+185 °F) Ingress protection: IP67 (correctly fitted) Fastening torque: 0.6 Nm</p>	<p>Material: CuZn nickel plated Termination: Solder Cable Ø: 3.5...5 mm (0.14...0.28 in.) Wire: 0.25 mm<sup>2</sup> Operating temperature: –40...+85 °C (–40...+185 °F) Ingress protection: IP67 (correctly fitted) Fastening torque: 0.5 Nm</p>

**Cables** **Cable sets**





			
<p><b>PUR signal cable</b> Part no. 530 125</p>	<p><b>PVC power cable</b> Part no. 530 108</p>	<p><b>Signal cable with M12 D-coded male connector (4 pin), straight – M12 D-coded, male connector (4 pin), straight</b> Part no. 530 064</p>	<p><b>Signal cable with M12 D-coded male connector (4 pin), straight – RJ45 male connector, straight</b> Part no. 530 065</p>
<p>Material: PUR jacket; green Features: Cat 5, highly flexible, halogen free, suitable for drag chains, mostly oil &amp; flame resistant Cable Ø: 6.5 mm (0.26 in.) Cross section: 2 × 2 × 0.35 mm<sup>2</sup> (22 AWG) Bending radius: 5 × D (fixed installation) Operating temperature: –20...+60 °C (–4...+140 °F)</p>	<p>Material: PVC jacket; gray Features: Shielded, flexible, mostly flame resistant Cable Ø: 4.9 mm (0.19 in.) Cross section: 3 × 0.34 mm<sup>2</sup> Bending radius: 5 × D (fixed installation) Operating temperature: –30...+80 °C (–22...+176 °F)</p>	<p>Material: PUR jacket; green Features: Cat 5e Cable length: 5 m (16.4 ft) Cable Ø: 6.5 mm (0.26 in.) Ingress protection: IP65, IP67, IP68 (correctly fitted) Operating temperature: –30...+70 °C (–22...+158 °F)</p>	<p>Material: PUR jacket; green Features: Cat 5e Cable length: 5 m (16.4 ft) Cable Ø: 6.5 mm (0.26 in.) Ingress protection M12 connector: IP67 (correctly fitted) Ingress protection RJ45 connector: IP20 (correctly fitted) Operating temperature: –30...+70 °C (–22...+158 °F)</p>

\*/ Follow the manufacturer's mounting instructions  
Controlling design dimensions are in millimeters and measurements in ( ) are in inches  
Color of connectors and cable jacket may change. Colors of the cores and technical properties remain unchanged.



Cable sets

Programming tools

			
<p><b>Power cable with M8 female connector (4 pin), straight – pigtail</b>  <b>Part no. 530 066 (5 m (16.4 ft.))</b>  <b>Part no. 530 096 (10 m (32.8 ft.))</b>  <b>Part no. 530 093 (15 m (49.2 ft.))</b></p>	<p><b>Power cable with M12 A-coded female connector (5 pin), straight – pigtail</b>  <b>Part no. 370 673</b></p>	<p><b>TempoLink® kit for Temposonics® R-Series V</b>  <b>Part no. TL-1-0-EM08 (D56)</b>  <b>Part no. TL-1-0-EM12 (D58)</b></p>	<p><b>TempoGate® smart assistant for Temposonics® R-Series V</b>  <b>Part no. TG-C-0-Dxx</b>          (xx indicates the number of R-Series V sensors that can be connected (even numbers only))</p>
<p>Material: PUR jacket; gray          Features: Shielded          Cable Ø: 5 mm (0.2 in.)          Operating temperature:          -40...+90 °C (-40...+194 °F)</p>	<p>Material: PUR jacket; black          Features: Shielded          Cable length: 5 m (16.4 ft.)          Ingress protection: IP67 (correctly fitted)          Operating temperature:          -25...+80 °C (-13...+176 °F)</p>	<ul style="list-style-type: none"> <li>• Connect wirelessly via Wi-Fi enabled device or via USB with the diagnostic tool</li> <li>• Simple connectivity to the sensor via 24 VDC power line (permissible cable length: 30 m)</li> <li>• User friendly interface for mobile devices and desktop computers</li> <li>• See data sheet “TempoLink® smart assistant” (document part no.: <a href="#">552070</a>) for further information</li> </ul>	<ul style="list-style-type: none"> <li>• OPC UA server for diagnostics of the R-Series V</li> <li>• For installation in the control cabinet</li> <li>• Connection via LAN and Wi-Fi</li> <li>• See data sheet “TempoGate® smart assistant” document part no.: <a href="#">552110</a> for further information</li> </ul>

Color of connectors and cable jacket may change. Colors of the cores and technical properties remain unchanged.

## ORDER CODE

1	2	3	4	5	6	7	8	9	10	11	12	13	14	15	16	17	18	19	20
R	F	V										D	5		1	U	4	0	
a			b	d						e	f			g	h				

<b>a</b>	<b>Sensor model</b>
R F V	Flexible rod

<b>b</b>	<b>Design</b>
B	Base unit
M	Threaded flange M18×1.5-6g (standard)
S	Threaded flange ¾"-16 UNF-3A (standard)

Section **c** is intentionally omitted.

<b>d</b>	<b>Stroke length</b>
X X X X X M	00150...20000 mm

Stroke length (mm)	Ordering steps
150... 1000 mm	50 mm
1000... 5000 mm	100 mm
5000...10000 mm	250 mm
10000...15000 mm	500 mm
15000...20000 mm	1000 mm

X X X X X U	0006.0...0787.0 in.
-------------	---------------------

Stroke length (in.)	Ordering steps
6... 40 in.	2 in.
40...197 in.	4 in.
197...394 in.	10 in.
394...591 in.	20 in.
591...787 in.	40 in.

Non standard stroke lengths are available; must be encoded in 5 mm/0.1 in. increments

<b>e</b>	<b>Number of magnets</b>
X X	01...30 position(s) (1...30 magnet(s))

<b>f</b>	<b>Connection type</b>
D 5 8	2×M12 female connectors (D-coded), 1×M12 male connector (A-coded)
D 5 6	2×M12 female connectors (D-coded), 1×M8 male connector

<b>g</b>	<b>System</b>
1	Standard

<b>h</b>	<b>Output</b>
U 4 0 2	PROFINET RT & IRT, position and velocity, linear profile (1...30 magnet(s))
U 4 0 1	PROFINET RT & IRT, position and velocity, encoder profile (1 magnet)

### NOTICE

- Select the linear profile (U402) in **h** "Output" for multi-position measurement.
- Specify number of magnets for your application and order the magnets separately.
- The number of magnets is limited by the stroke length. The minimum allowed distance between magnets (i.e. front face of one to the front face of the next one) is 75 mm (3 in.).
- Use magnets of the same type for multi-position measurement.

## DELIVERY



### RFV-B:

- Base unit (without flange & rod assembly)
- 3 × socket screws M4×59

### RFV-M/-S:

- Sensor
- O-ring

Accessories have to be ordered separately.

Manuals, Software & 3D Models available at:  
[www.temposonics.com](http://www.temposonics.com)

## GLOSSARY

### E

#### Encoder Profile

The encoder profile corresponds to the specification of the encoder profile V4.2 (PNO no. 3.162). With this profile, the position and the velocity of one magnet can be measured and transferred simultaneously. (→ Linear Profile)

#### Extrapolation

The native measurement cycle time of a sensor increases with the stroke length. With extrapolation, the sensor is able to report data faster than the native cycle time, independent of the stroke length of the sensor. Without extrapolation, if data is requested faster than the native cycle time, the last measured value is repeated.

### G

#### GSDML

The properties and functions of a PROFINET IO field device are described in a GSDML file (**G**eneral **S**tation **D**escription). The XML-based GSDML file contains all relevant data that are important for the implementation of the device in the controller as well as for data exchange during operation. The GSDML file of the R-Series V PROFINET is available on the homepage [www.temposonics.com](http://www.temposonics.com).

### I

#### IRT Filter

With PROFINET IRT (**I**sochronous **R**eal **T**ime) a clock-synchronous data transmission takes place. The application, the data transmission as well as the device cycle are synchronous. IRT enables a clock-synchronous data exchange with a minimum cycle time of 250 µs in the network. The R-Series V PROFINET supports PROFINET RT and IRT. (→ RT)

### L

#### Linear Profile

The linear profile was developed by Temposonics and is tailored to the characteristics of magnetostrictive position sensors. With this profile, the positions and velocities of up to 30 magnets can be reported and transferred simultaneously. (→ Encoder Profile)

### M

#### Multi-position measurement

During the measurement cycle, the positions of every magnet on the sensor are simultaneously reported. The velocity is continuously calculated based on these changing position values as the magnets are moved.

### P

#### PROFINET

PROFINET (**P**rocess **F**ield **N**etwork) is an Industrial Ethernet interface and is managed by the **PROFIBUS Nutzerorganisation e.V.** (PNO). The R-Series V PROFINET and its corresponding GSDML file are certified by the PNO.

### R

#### RT

With PROFINET RT (**R**eal **T**ime) the data exchange is without clock synchronization. In this case, the application, the data transmission and the field devices operate according to their own processing cycle. The R-Series V PROFINET supports PROFINET RT and IRT. (→ IRT)

**UNITED STATES**  
**Temposonics, LLC**  
Americas & APAC Region  
3001 Sheldon Drive  
Cary, N.C. 27513  
Phone: +1 919 677-0100  
E-mail: [info.us@temposonics.com](mailto:info.us@temposonics.com)

---

**GERMANY**  
**Temposonics**  
**GmbH & Co. KG**  
EMEA Region & India  
Auf dem Schüffel 9  
58513 Lüdenscheid  
Phone: +49 2351 9587-0  
E-mail: [info.de@temposonics.com](mailto:info.de@temposonics.com)

---

**ITALY**  
Branch Office  
Phone: +39 030 988 3819  
E-mail: [info.it@temposonics.com](mailto:info.it@temposonics.com)

---

**FRANCE**  
Branch Office  
Phone: +33 6 14 060 728  
E-mail: [info.fr@temposonics.com](mailto:info.fr@temposonics.com)

---

**UK**  
Branch Office  
Phone: +44 79 21 83 05 86  
E-mail: [info.uk@temposonics.com](mailto:info.uk@temposonics.com)

---

**SCANDINAVIA**  
Branch Office  
Phone: +46 70 29 91 281  
E-mail: [info.sca@temposonics.com](mailto:info.sca@temposonics.com)

---

**CHINA**  
Branch Office  
Phone: +86 21 2415 1000 / 2415 1001  
E-mail: [info.cn@temposonics.com](mailto:info.cn@temposonics.com)

---

**JAPAN**  
Branch Office  
Phone: +81 3 6416 1063  
E-mail: [info.jp@temposonics.com](mailto:info.jp@temposonics.com)

**Document Part Number:**  
552126 Revision A (EN) 11/2022



**[temposonics.com](http://temposonics.com)**