

Temposonics®

Absolute, Non-Contact Position Sensors



ATEX Approved Sensors
Temposonics® R- and G-Series

Instruction manual



Sensor with Ex approval

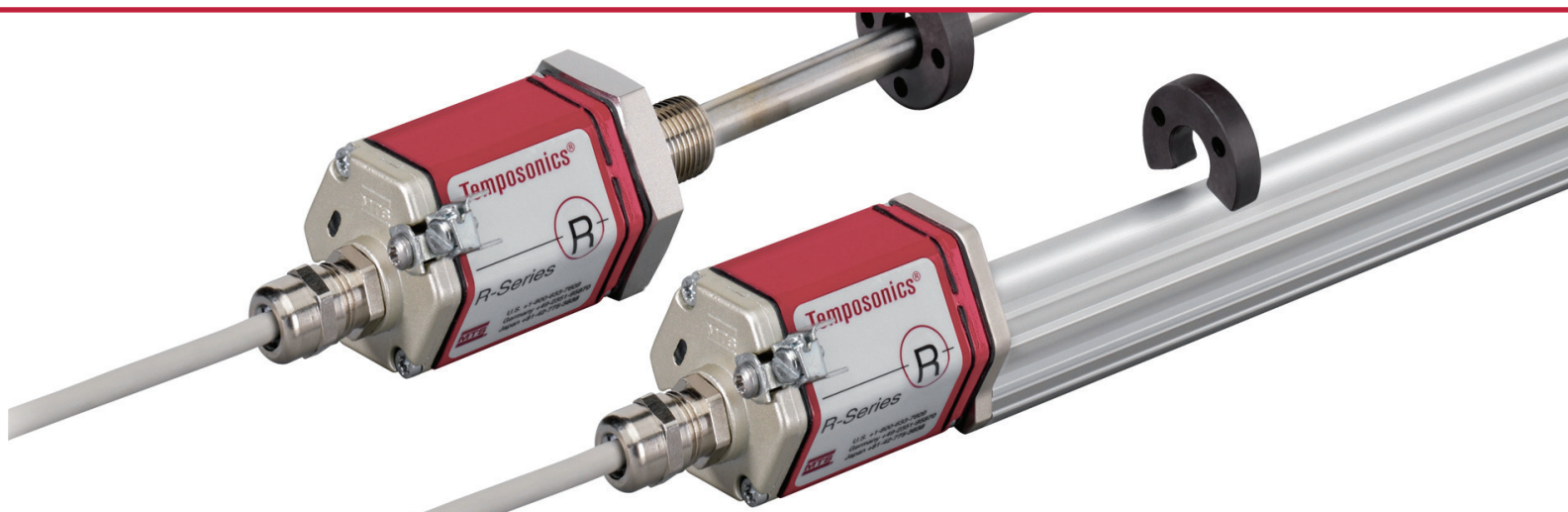

Content

1 General

2 Safety Instructions

2.1 Installation Instructions

3 Product Description

3.1 Operating Principle and System Design

3.2 Profile Models Temposonics® RP / GP

3.3 Rod Models Temposonics® RH / GH

3.4 Basic Sensor

4 Installation

5 Technical Information

5.1 Temposonics® R-Series

5.2 Temposonics® G-Series

6 Sensor Model Article coding

7 Installation details

1. General



This sign identifies an important information



This sign indicates that, the personnel damage such as death or bodily injury, or considerable damage to property are susceptible to occur, unless appropriate precautions are taken.



Information related to the explosion and its protective measures.

The content of this technical documentation is intended to provide quick information for mounting, installation and commissioning by specialized automation personnel ¹⁾ or trained service technicians who are familiar with Temposonics® sensor projecting and handling.

Please, read this documentation carefully before Temposonics® sensor commissioning, follow the mentioned safety instructions.

Warranty ²⁾

In case of material deficiencies and faults which occur despite operation in compliance with the regulations, the warranty assumed by MTS for Temposonics® position sensors is 12 months starting with the reception of the product. The MTS liability is limited to repair or replacement of every defective part of the instrument. No warranty can be assumed for deficiencies due to improper handling or above average overload of the product, and for wear parts. MTS cannot be held responsible for consequences or side effects in case of infliction against the warranty conditions ²⁾, independent of whether promised or expected, not even in case of manufacturer error or negligence.

In this respect, MTS explicitly precludes any further warranty. Neither MTS representatives, agents and dealers nor employees are authorized to increase or change the warranty conditions.

¹⁾ Specialized personnel means persons who

- are familiar with the automation safety concepts related to projecting
- are familiar with EMC questions and standards
- have undergone training for commissioning and servicing
- are familiarized with the operation of the instrument and know the information for correct operation provided in the product documentation.
- have a qualification similar to “authorized person” according to TRBS 1203

²⁾ See also MTS sales and delivery conditions www.mtssensor.de

2. Safety Instructions

Please, read this documentation carefully before sensor operation and follow the safety instructions!

Specified normal operating conditions

This product may be used only for the applications provided by the technical description and only in conjunction with third-party units and components recommended or approved by MTS. Prerequisites of correct and safe product operations are proper transport, storage, mounting, commissioning and careful operation.

1. The position measurement systems of all Temposonics® series are intended exclusively for measurement in industrial, trade and laboratory applications. The position sensors are considered as system accessories and must be connected to a suitable unit for electronic evaluation as e.g. included in a PLC, IPC, indicator or other electronic control facility.
2. The position sensors must be used only in safe condition. In order to maintain this condition and to ensure safe operation, installation, connection and service may be done only by specialized and qualified personnel.

Information related to danger



Information related to danger is intended for your personal safety and for the safety against damage of the described product or instruments connected to it. Safety hints and warnings for prevention of damage to the life and health of users or repair and maintenance personnel, or for prevention of damage to property are highlighted in these instructions by the pictogram defined above.

2.1 Installation Instructions

Functional trouble:

If failure or disfunction of the sensor imply a risk of injury to persons or damage of production facilities, additional safety measures such as plausibility checks, limit switches, EMERGENCY OFF systems, protective devices etc. must be taken. In case of trouble, the sensor must be taken out of operation and protected against accidental operation.

Repairs:

Any sensor repairs may be done only by MTS or by an organization explicitly authorized by MTS.

Installation and Repair:

In order to maintain the operability of the product, it is indispensable to follow the rules given below:

1. Protect the sensors against mechanical stress during installation and operation.
- 1a. The probe of the basis sensor has to be attached to the housing that meets all requirements of the standards EN 60079-0, EN 60079-7, EN 60079-31 with regards to thermal conditioning as well as shock- and IP-testing.
- 1b. The basic sensor has to be attached to the potential equalization bonding over a dedicated connection. It is to be treated in accordance with the erection regulations in the user country. The potential equalization connection is loosely attached to the partly assembled device. This connection must be established by mounting of the device in accordance with the aforementioned regulations.
2. Do not open or disassemble the sensors. **DO NOT OPEN WHEN AN EXPLOSIVE ATMOSPHERE IS PRESENT AND DO NOT OPEN WHEN ENERGIZED!**
3. Connect the sensors very carefully related to polarity, supply voltage and form as well as duration of control pulses.
4. Use only appropriate power supplies.
5. Compliance with the permissible sensor limit values for e.g. operating voltage, environmental conditions etc. as specified in the product documentation is indispensable.
6. Check the position sensor function regularly including documentation.
7. Before switching on the system, make sure that danger for persons due to starting machinery is precluded.
8. Connectors must not be detached in the presence of explosive atmosphere. A warning label is mandatory (e.g. "Caution! Only disconnect in safe areas!")
9. Connectors have to be secured against accidental unfastening, for example with low strength thread locker. A torque von 0,5..1,5 Nm on an equivalent M10 thread has to be achieved.
10. Connectors must not be energized when disconnected.
11. Unused connectors have to be closed with appropriate caps.

3. Product Description

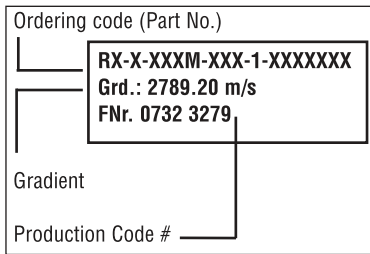

Fig: 1 Sensor Example

Product Types

Position sensors Temposonics® R- and G-Series.

Sensor models:

- Temposonics® - RP / GP (Profile housing)
- Temposonics® - RH / GH (Rod housing)
- Measuring range: RP/GP/GH: 50...1650 mm / RH: 50...6000 mm*
- Output Signal: Selectable R-Series: Analog / SSI / CANbus
G-Series: Analog / Start-Stop

ATEX Identification according 3.2, 3.3 and 3.4

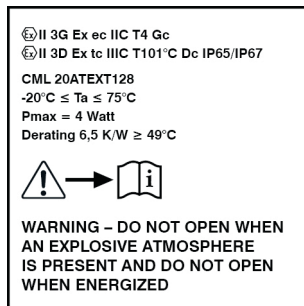

Industrial Field of Application:

Temposonics® position sensors are used for displacement measurement and conversion in mechanical and plant engineering applications.

3.1 Operating Principle and System Design

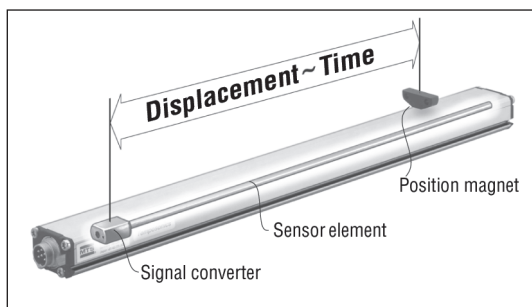

Fig.: 2

Magnetostrictive ultrasonic speed measurement = position measurement

Temposonics® are absolute position sensors for measuring linear movements. The sensor associates various magneto-mechanical effects in a magnetostrictive measurement principle, which uses the defined propagation speed of an ultrasonic wave – a torsional pulse in the sensor element – for displacement measurement. This contactless principle features a permanent magnet without separate power supply, which marks the position point through the sensor housing wall. The torsion pulse speed measurement can be converted directly into high-accuracy standard market output signals, strictly proportional to the measured displacement. The non-contact sensors eliminate the wear, noise and erroneous signal problems and guarantee the best durability without any recalibration. Their absolute nature provides instant recognition of machine position after power loss recovery.

Modular Form Factor:

The extremely robust sensor, ideal for continuous operation under harshest industrial conditions is completely modular in mechanics and electronics design.

- A rod-shaped sensor housing protects the sensing element in which gives rise to the measurement signal.
- The sensor head accommodates the complete modular electronic interface with active signal conditioning. Double encapsulation ensures high operating safety and optimum EMC protection.
- The position transmitter, a permanent magnet - fixed at the mobile machine part - drives contactlessly over the sensor's stroke and starts measuring through the housing wall.

*for stroke lengths >1650 mm use only magnet #254 012 or magnet #253 928

3.2 Profile Models Temposonics®-RP / GP

Measurement is non-contact via two versions of permanent magnets:

- A sliding magnet running in profile housing rails. Connection with the mobile machine part is via a ball jointed arm to taking up axial forces.
- A floating magnet, mounted directly on the moving machine part, travels over the profile at a low distance. An air-gap allows the correction of small misalignments at installation.

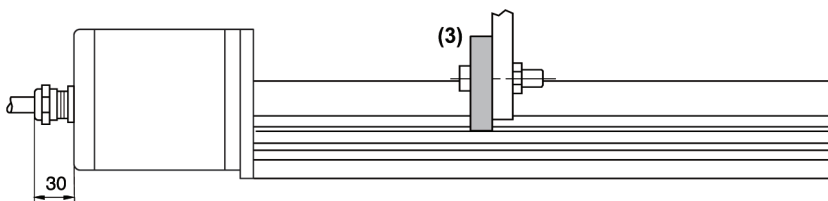
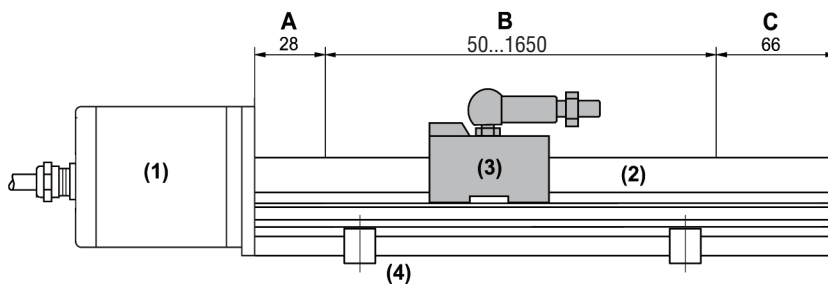
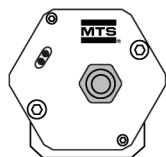
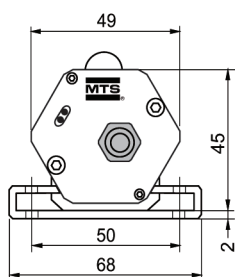

- 1 Sensor head with electronics
- 2 Sensor housing with built-in sensing element
- 3 Position magnet
- 4 Mounting clamp

- A Mounting zone
- B Measuring range / Order length (depends on sensor type)
- C Inactive zone

i See in the corresponding data sheets for output dependent minimum variations of the sensors head dimension.

Selection of Profile Position Magnets

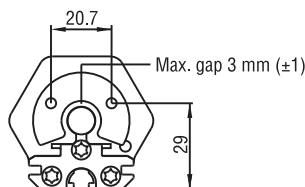
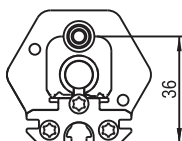
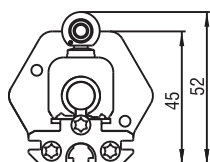

Magnet slider S
Part No. 252 182

Magnet slider V
Part No. 252 184

U-Magnet M OD33
Part No. 251 416-2

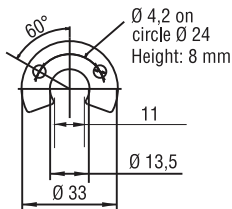
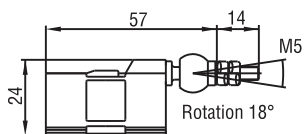
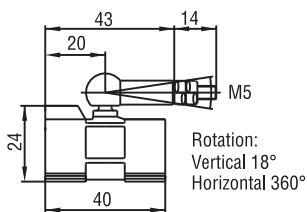

GFK, Magnet Hardferrite
Ball joint CuZn39Pb3 nickel plated
Weigh ca. 30 g
Operating temperature:
-40 ... +75°C

GFK, Magnet Hardferrite
Ball joint CuZn39Pb3 nickel plated
Weigh ca. 30 g
Operating temperature:
-40 ... +75°C

PA-Ferrit-GF20
Weigh ca. 11g
Operating temperature: -40 ... +100°C
Surface pressure max. 40 N/mm²
Fastening torque for M4 screws max. 1 Nm

3.3 Rod Models Temposonics® -RH / GH

The sensor with a pressure-resistant stainless steel flange and sensing rod is suitable for use in hydraulic cylinders and externally in all applications where space is a problem.

Position measurement is via ring or U-magnets travelling along the sensing rod without any mechanical contact.

Advantages...

The completely operable sensor cartridge can be replaced for servicing easily without opening the fluid circuit. Measurement is non-contact via two versions of permanent magnets.

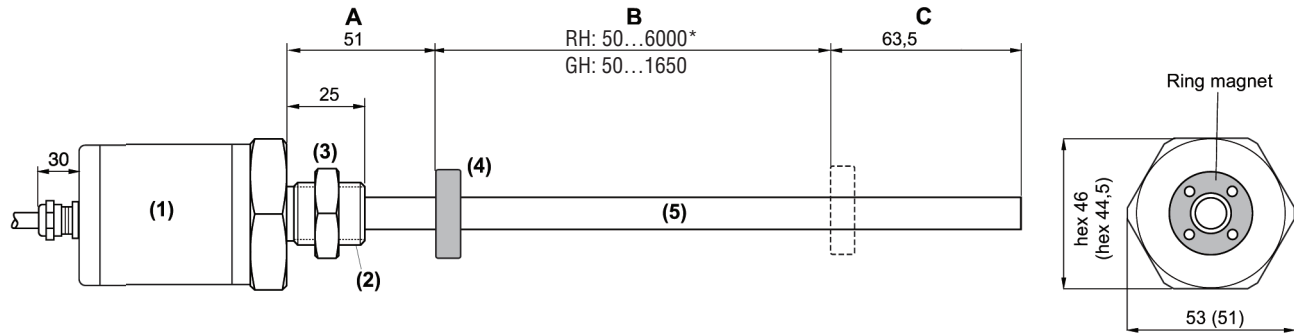

- 1 Sensor head with electronics
- 2 Threaded flange, M18 x 1,5 or 3/4" - 16 UNF-3A
- 3 Hex nut 18 x 1,5 (hex 27)
- 4 Position magnet
- 5 Sensor rod with built-in sensing element, Ø 10

i See in the corresponding data sheets for output dependent minimum variations of the sensors head dimension.

- A Mounting zone
- B Measuring range / Order length (depends on sensor type)
- C Inactive zone

*for stroke lengths >1650 mm use only magnet #254 012 or magnet #253 928

Selection of Rod Position Magnets

| Position magnets | | |
|--|---|--|
| | | |
| U-magnet OD33 Part no. 251 416-2 Material: PA ferrite GF20 Weight: Approx. 11 g Surface pressure: Max. 40 N/mm ² Fastening torque for M4 screws: 1 Nm Operating temperature: -40...+105 °C (-40...+221 °F) | Ring magnet OD33 Part no. 201 542-2 Material: PA ferrite GF20 Weight: Approx. 14 g Surface pressure: Max. 40 N/mm ² Fastening torque for M4 screws: 1 Nm Operating temperature: -40...+105 °C (-40...+221 °F) | Ring magnet OD25.4 Part no. 400 533 Material: PA ferrite Weight: Approx. 10 g Surface pressure: Max. 40 N/mm ² Operating temperature: -40...+105 °C (-40...+221 °F) |
| Position magnet | | |
| | | |
| System magnet Part no. 253 928 Material: Composite POM Weight: Approx. 14 g Surface pressure: Max. 20 N/mm ² Operating temperature: -40...+75 °C (-40...+167 °F) | Ring magnet OD20 Part no. 254 012 Material: Composite neobonded Weight: Approx. 8.5 g Surface pressure: Max. 20 N/mm ² Operating temperature: -40...+75 °C (-40...+167 °F) | |

3.4 Basic Sensor

R-Series: Type RH-B... resp. Type RH-G...
G-Series: Type GH-B... resp. Type GH-G...

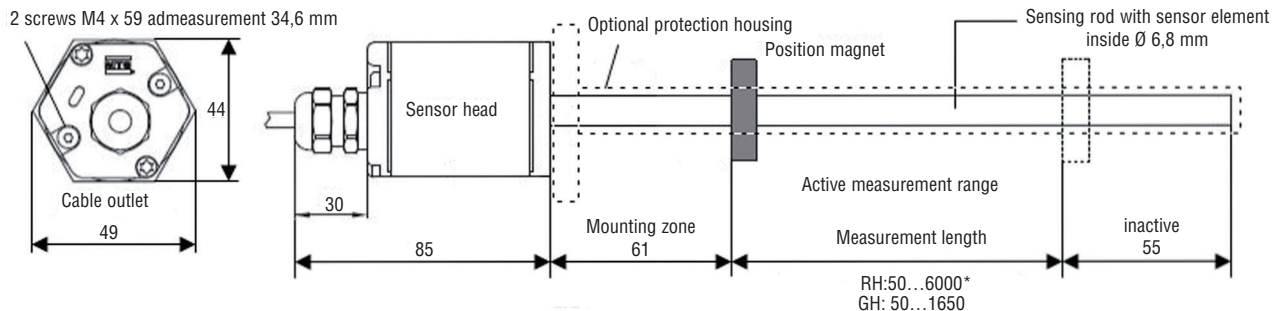

The probe of the above basic sensor has to be attached to a housing, which meets the requirements of standards EN 60079-0, EN 60079-7 and EN 60079-31 in terms of thermal conditioning, shock- and IP-testing.

The installation of the basic sensor into the housing has to be done by trained personnel only. The screws have to be secured with thread locker e.g. Loctite 243 (Fig. 1), the fastening torque is 1,3 Nm. The gasket between the sensor head and the housing has to have the correct position and has to seal up the chink safely.

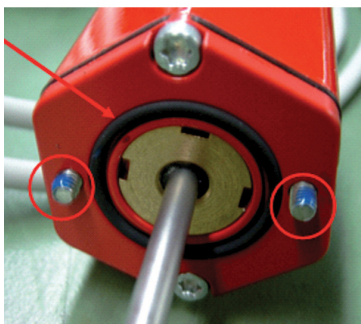

Fig. 1: Secure screws with thread locker, check the correct position of the gasket

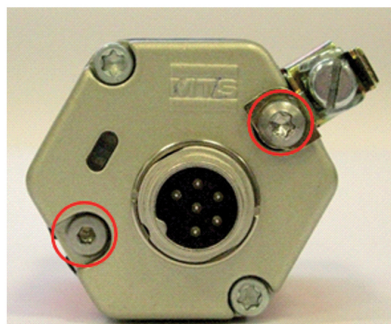
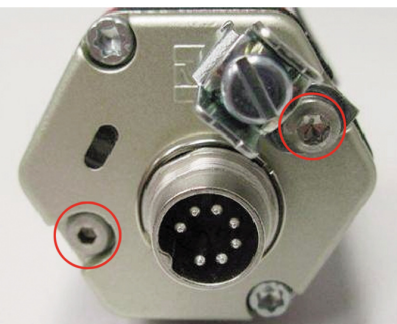



Fig. 2: Fasten screws with 1,3 Nm



The basic sensor has to be grounded over the dedicated connection (see Fig. 2). This connection has to be done in according to the local law and regulations. The ground connection is attached to the sensor. By mounting the sensor the fastening (Fig. 2) and protection must follow the rules (see chapter 7, installation details).

R-Series Analog

| D60 | | | |
|---|--------|-----|-----------------------|
| Signal + power supply | | | |
| M16 male connector | Output | Pin | Function |
|  <p>View on sensor</p> | 1 | 1 | Position (magnet 1) |
| | | 2 | Signal Ground |
| | 2* | 3 | Position (magnet 2) |
| | | 4 | Signal Ground |
| | | 5 | +24 VDC (-15 / +20 %) |
| | | 6 | DC Ground (0 V) |

* order dependent

R-Series CANbus

| D60 | | |
|--|-----|-----------------------|
| Signal + power supply | | |
| M16 male connector | Pin | Function |
|  <p>View on sensor</p> | 1 | CAN_L |
| | 2 | CAN_H |
| | 3 | Not connected |
| | 4 | Not connected |
| | 5 | +24 VDC (-15 / +20 %) |
| | 6 | DC Ground (0 V) |

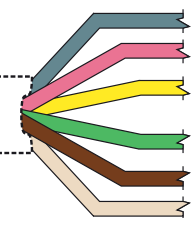
| H.XX / R.XX / T.XX | | | |
|--|--------|-------|--|
| Signal + power supply | | | |
| Cable | Output | Color | Function |
|  | 1 | GY | Position (magnet 1) |
| | | PK | Signal Ground |
| | 2* | YE | Position (magnet 2) or reverse position (magnet 1) or speed or velocity (magnet 1) |
| | | GN | Signal Ground |
| | | BN | +24 VDC (-15 / +20 %) |
| | | WH | DC Ground (0 V) |

* order dependent

For cable type TXX, the extra red and blue wires are not used.

| D62 | | |
|---|-----|-----------------------|
| Signal + power supply | | |
| M16 male connector | Pin | Function |
|  <p>View on sensor</p> | 1 | CAN_L |
| | 2 | CAN_H |
| | 3 | Not connected |
| | 4 | Not connected |
| | 5 | +24 VDC (-15 / +20 %) |
| | 6 | DC Ground (0 V) |

| M16 male connector | Pin | Function |
|--|-----|-----------------------|
|  <p>View on sensor</p> | 1 | CAN_L |
| | 2 | CAN_H |
| | 3 | Not connected |
| | 4 | Not connected |
| | 5 | +24 VDC (-15 / +20 %) |
| | 6 | DC Ground (0 V) |

R-Series CANbus

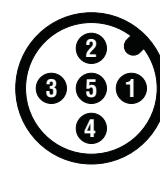
| D31 & D51 | | |
|---|-----|-----------------------|
| Signal + power supply | | |
| M12 male connector (A-coded) | Pin | Function |
|  <p>View on sensor</p> | 1 | Shield |
| | 2 | +24 VDC (-15 / +20 %) |
| | 3 | DC Ground (0 V) |
| | 4 | CAN_H |
| | 5 | CAN_L |

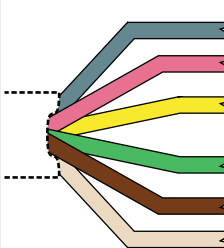
| P.XX | | |
|--|-------|-----------------------|
| Signal + power supply | | |
| Cable | Color | Function |
|  | GY | CAN_L |
| | PK | CAN_H |
| | YE | Not connected |
| | GN | Not connected |
| | BN | +24 VDC (-15 / +20 %) |
| | WH | DC Ground (0 V) |

R-Series SSI

| D70 | | |
|---|-----|-----------------------|
| Signal + power supply | | |
| M16 male connector | Pin | Function |
|  <p>View on sensor</p> | 1 | Data (-) |
| | 2 | Data (+) |
| | 3 | Clock (+) |
| | 4 | Clock (-) |
| | 5 | +24 VDC (-15 / +20 %) |
| | 6 | DC Ground (0 V) |
| | 7 | Not connected |

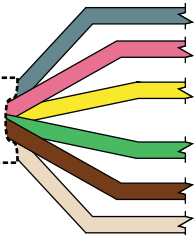
| PXX | | |
|--|-------|-----------------------|
| Signal + power supply | | |
| Cable | Color | Function |
|  | GY | Data (-) |
| | PK | Data (+) |
| | YE | Clock (+) |
| | GN | Clock (-) |
| | BN | +24 VDC (-15 / +20 %) |
| | WH | DC Ground (0 V) |

G-Series Analog

| D60 | | |
|--|-----|-----------------------|
| M16 connector | Pin | Function |
|  <p>View on sensor</p> | 1 | Position |
| | 2 | DC Ground |
| | 3 | USB programmer |
| | 4 | USB programmer |
| | 5 | +24 VDC (-15 / +20 %) |
| | 6 | DC Ground (0 V) |

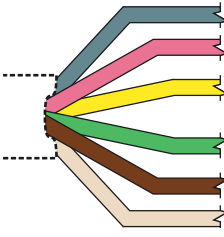
| HXX / RXX / TXX | | |
|--|-------|-----------------------|
| Cable | Color | Function |
|  | GY | Position |
| | PK | DC Ground |
| | YE | USB programmer |
| | GN | USB programmer |
| | BN | +24 VDC (-15 / +20 %) |
| | WH | DC Ground (0 V) |

For cable type TXX, the extra red and blue wires are not used.

G-Series Start/Stop

| D60 | | |
|--|-----|-----------------------|
| M16 connector | Pin | Function |
|  <p>View on sensor</p> | 1 | Stop (-) |
| | 2 | Stop (+) |
| | 3 | Start (+) |
| | 4 | Start (-) |
| | 5 | +24 VDC (-15 / +20 %) |
| | 6 | DC Ground (0 V) |

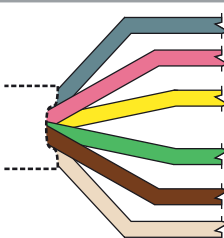
| HXX / RXX / TXX | | |
|--|-------|-----------------------|
| Cable | Color | Function |
|  | GY | Stop (-) |
| | PK | Stop (+) |
| | YE | Start (+) |
| | GN | Start (-) |
| | BN | +24 VDC (-15 / +20 %) |
| | WH | DC Ground (0 V) |

For cable type TXX, the extra red and blue wires are not used.

4. Installation

Measuring Range

All the technical data of each Temposonics® sensor are checked and recorded at the final quality inspection. At the same time the active electrical stroke (see data sheet) is adjusted.



With all sensors described in the manual, the areas left and right of the stroke length are inactive (mounting area, damping) and should not be used for measurements. Nevertheless, the stroke length can be overtravelled.

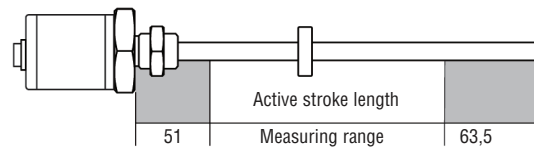
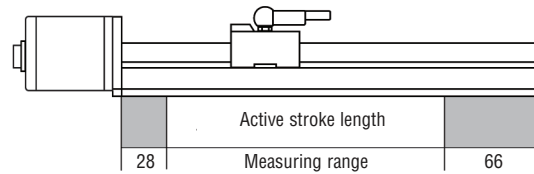

Fig. 3
Temposonics® Profile models with magnet slider S and V

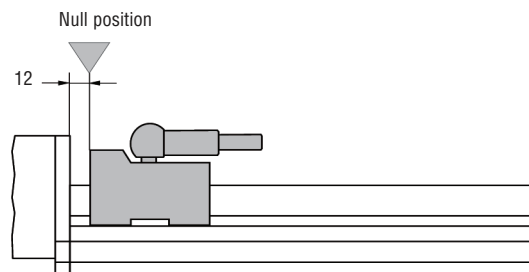

Fig. 4
Temposonics® Profile models with U-Magnet OD33 (corresponding magnet M)

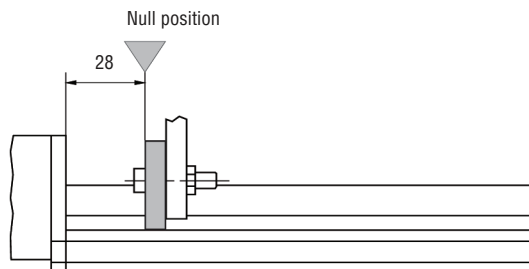
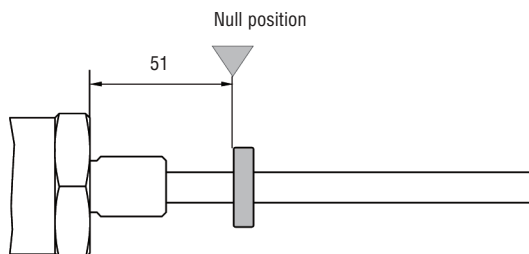

Fig. 5
Temposonics® Rod models with ring magnet



Connectors (if applicable)

It has to be assured that the connectors can not easily or accidentally be disconnected with the sensor energized. This is achieved by securing the connector in a mechanical way, e.g. with a low strength thread locker. If any vibration during the operation may cause parts of the plugs to loosen, then the plugs have to be provided with a light firm varnish used for securing screws. An extraction force of 0.5 .. 1.5 Nm has to be achieved at an equivalent M10 thread.

Use a low strength thread locker in a sparing way, otherwise the opening torque will become too high.

Additional warning hints on labels are mandatory according to the ATEX regulations (e.g. "Caution! Only disconnect in safe areas!").

Unused connectors must be closed with appropriate caps.

On sensors with the identification number RX-X-XXXXM-D3X-1-X-XXXXXXX the connector must be protected from being hit by external forces.

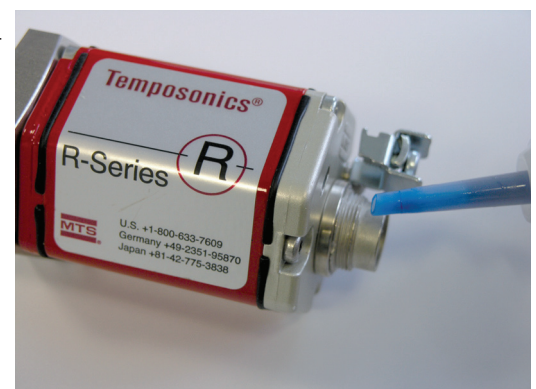

5.1 Technical Information: R-Series

| Input | | | | | | | | | | | | | | | |
|---|--|------------------|-----------|-----------|-----------|-------------------|---------|-----------|---------|-----------|-----------|-----------|-----------|--------|-------|
| Measurement quantity | Analog: position, speed CANbus: position, speed SSI: position, position difference between 2 magnets, velocity | | | | | | | | | | | | | | |
| Measurement length | Profile version: 50...1650 mm Rod version: 50...6000 mm* | | | | | | | | | | | | | | |
| Output | | | | | | | | | | | | | | | |
| <u>Analog Version</u> | | | | | | | | | | | | | | | |
| Voltage | 0...10 / 10...0 / -10...+10 / +10...-10 V DC (min. load controller > 5 KΩ) | | | | | | | | | | | | | | |
| Current | 4(0)...20 mA / 20...4(0) mA (min / max. load : 0/500 Ω) | | | | | | | | | | | | | | |
| <u>CANbus Version</u> | | | | | | | | | | | | | | | |
| CANopen CIA Standard DS 301 V3.0 / encoder profile DS 406 V3.1, CANbasic CAN 2.0A | | | | | | | | | | | | | | | |
| Baudrate, kBit/s | <table border="1"> <tr> <td>1000</td> <td>800</td> <td>500</td> <td>250</td> <td>125</td> <td>50</td> <td>20</td> </tr> <tr> <td>< 25</td> <td>< 50</td> <td>< 100</td> <td>< 250</td> <td>< 500</td> <td>< 1000</td> <td>< 250</td> </tr> </table> | 1000 | 800 | 500 | 250 | 125 | 50 | 20 | < 25 | < 50 | < 100 | < 250 | < 500 | < 1000 | < 250 |
| 1000 | 800 | 500 | 250 | 125 | 50 | 20 | | | | | | | | | |
| < 25 | < 50 | < 100 | < 250 | < 500 | < 1000 | < 250 | | | | | | | | | |
| <u>SSI Version</u> | | | | | | | | | | | | | | | |
| Data format | Binary or Gray, Optional Parity and Error bit | | | | | | | | | | | | | | |
| Data length | 8...32 Bits | | | | | | | | | | | | | | |
| Update Time | <table border="1"> <tr> <td>Measuring length</td> <td>300</td> <td>750</td> <td>1000</td> </tr> <tr> <td>Measurements / ms</td> <td>3,7</td> <td>3,0</td> <td>2,3 KHz</td> </tr> </table> | Measuring length | 300 | 750 | 1000 | Measurements / ms | 3,7 | 3,0 | 2,3 KHz | | | | | | |
| Measuring length | 300 | 750 | 1000 | | | | | | | | | | | | |
| Measurements / ms | 3,7 | 3,0 | 2,3 KHz | | | | | | | | | | | | |
| Data speed | <table border="1"> <tr> <td>Length</td> <td>< 3</td> <td>< 50</td> <td>< 100</td> <td>< 200</td> <td>< 400 m</td> </tr> <tr> <td>Baud rate</td> <td>1,0 MBd</td> <td>< 400 KBd</td> <td>< 300 KBd</td> <td>< 200 KBd</td> <td>< 100 KBd</td> </tr> </table> | Length | < 3 | < 50 | < 100 | < 200 | < 400 m | Baud rate | 1,0 MBd | < 400 KBd | < 300 KBd | < 200 KBd | < 100 KBd | | |
| Length | < 3 | < 50 | < 100 | < 200 | < 400 m | | | | | | | | | | |
| Baud rate | 1,0 MBd | < 400 KBd | < 300 KBd | < 200 KBd | < 100 KBd | | | | | | | | | | |
| Accuracy | | | | | | | | | | | | | | | |
| <u>Position Measurement</u> | | | | | | | | | | | | | | | |
| Resolution | depends on the output | | | | | | | | | | | | | | |
| Linearity** | < ± 0.01 % of full scale (Minimum ± 50 μm) | | | | | | | | | | | | | | |
| Repeatability | < ± 0.001 % of full scale (Minimum ± 2,5 μm) | | | | | | | | | | | | | | |
| Speed Measurement | | | | | | | | | | | | | | | |
| Magnet speed | < 1m/s | | | | | | | | | | | | | | |
| Operating temperature | - 20°C...+ 75°C, Pmax= 4 Watt, derating 6,5 K/W ≥ 49°C | | | | | | | | | | | | | | |
| Dew point, humidity | 90% rel. humidity, no condensation | | | | | | | | | | | | | | |
| Protection | Profile: IP 65, rod: IP67 | | | | | | | | | | | | | | |
| Shock test | 100 g single hit, IEC-Standard 68-2-27 | | | | | | | | | | | | | | |
| Vibration | 15 g /10 - 2000 Hz IEC-Standard 68-2-6 (excluding resonant frequencies) | | | | | | | | | | | | | | |
| EMC test standards | Electromagnetic emission according to EN 61000-6-4 Electromagnetic immunity according to EN 61000-6-2 conform according EMC directive 2014/30/EU and CE marked | | | | | | | | | | | | | | |
| Formfactor, Material | | | | | | | | | | | | | | | |
| Sensor housing | Aluminium | | | | | | | | | | | | | | |
| Sensor stroke | Profile version: Aluminium, rod version: Stainless steel 1.4306 / AISI 304L | | | | | | | | | | | | | | |
| Position magnet | Magnet slider or removable U-magnet | | | | | | | | | | | | | | |
| Installation | | | | | | | | | | | | | | | |
| Mounting position | Any orientation | | | | | | | | | | | | | | |
| Profile version | Movable mounting clamps fixed with M5 × 20 screws or T-Slot nuts M5 in base channel | | | | | | | | | | | | | | |
| Rod version | Threaded Flange M18 × 1.5 or ¾"- 16 UNF-3A, Hex nut M18 | | | | | | | | | | | | | | |
| Electrical connection | | | | | | | | | | | | | | | |
| Connection type | Cable outlet or connector (D60, D70, D62, D51) Cable Types: PUR cable K59, Teflon cable K34, PVC cable K27 | | | | | | | | | | | | | | |
| Current consumption | 120 mA typically | | | | | | | | | | | | | | |
| Ripple | < 1 % P-P | | | | | | | | | | | | | | |
| Electrical strength | 500 VDC (0 V to machine ground) | | | | | | | | | | | | | | |

* for stroke lengths >1650 mm use only magnet #254 012 or magnet #253 928
** with position magnet # 251 416-2

5.2 Technical Information: G-Series

| | |
|------------------------------|--|
| Input | |
| Measurement quantity | Analog: position Digital: position |
| Measurement length | Profile version: 50...1650 mm Rod version: 50...1650 mm |
| Output | |
| <u>Analog version</u> | |
| Voltage | 0...10 / 10...0 / -10...+10 / +10...-10 V DC (min. load controller > 5 K Ω) |
| Current | 4(0)...20mA / 20...4(0) mA (min / max. Load: 0/500 Ω) |
| <u>Digital Version</u> | |
| | Start / Stop Pulse (RS422 Serial Differential Signal) |
| Accuracy | |
| Position measurement | |
| Null / span adjustment | 100% of electrical stroke (Min range 50 mm) |
| Resolution | Analog: infinite Digital (Start/Stop): 0,1mm, 0,01; 0,005 mm (controller dependent) |
| Linearity* | < $\pm 0,02$ % of full scale (Minimum ± 50 μ m) |
| Repeatability | < $\pm 0,001$ % of full scale (Minimum $\pm 2,5$ μ m) |
| Speed Measurement | |
| Magnet speed | < 1m/s |
| Operating temperature | -20 °C...+75 °C, Pmax= 4 Watt, derating 6,5 K/W ≥ 49 °C |
| Dew point, humidity | 90% rel. humidity, no condensation |
| Protection | Profile: IP 65, Rod: IP67 |
| Shock test | 100 g single hit, IEC-Standard 68-2-27 |
| Vibration | 15 g/10 – 2000 Hz, IEC 68-2-6 (excluding resonant frequencies) |
| EMC test standards | Electromagnetic emission according to EN 61000-6-4 Electromagnetic immunity according to EN 61000-6-2 Conform according EMC directive 2014/30/EU and CE marked |
| Formfactor, material | |
| Sensor housing | Aluminum |
| Sensor stroke | Profile version: Aluminium, rod version: stainless steel 1.4306 / AISI 304L |
| Position magnet | Magnet slider or removable U-magnet |
| Installation | |
| Mounting position | Any orientation |
| Profile version | Movable mounting clamps fixed with M5 \times 20 screws or T-Slot nuts M5 in base channel |
| Rod version | Threaded flange M18 \times 1.5 or $\frac{3}{4}$ "- 16 UNF-3A, Hex nut M18 |
| Electrical Connection | |
| Connection type | Cable outlet or connector (D60) Cable Types: PUR cable K59, Teflon cable K34, PVC cable K27 |
| Current consumption | 100 mA typically |
| Ripple | < 1 % P-P |
| Electrical strength | 500 V (DC Ground to machine ground) |

* with position magnet # 251 416-2

6. Sensor Model Article coding

R Series: Analog

RX-X-XXXXM-XXX-1-XXXXXX-EX
ab-c-defgM-hij-1-klmnopq-rs

Where,

a = Model Name R-Series
b = Housing Version: P = Profile / H = Hydraulic Rod
c = Rod Version: M = Flange M18 × 1.5 or S = ¾"- 16 UNF-3A or B = basic unit
 Profile Version: S = Captive sliding magnet with ball joint at top or V = Captive sliding magnet with ball joint at front or M = U- Magnet
defgM = Measuring Length in millimeter (RP: 50...1650 mm / RH: 50...6000 mm*)
hij = Connection Type: H = PUR cable K59 or T = Teflon cable K34 or R = PVC cable K27 with length in meter or D60 = connector 6 pin male receptacle M16
1 = Excitation input voltage (+24 V)
klmnopq = Analog Type Versions (Voltage or current)
 A01 = 4...20 mA or A11 = 20...4 mA or A21 = 0...20 mA or A31 = 20...0 mA
 V01 = 0...10 V or V11 = 10...0 V or V21 = -10...+10 V or V31 = +10...-10 V
rs = EX = ATEX approved

R Series: CANbus

RX-X-XXXXM-XXX-1-C-XXXXXX-EX
ab-c-defgM-hij-1-C-klmnop-qr

Where,

a = Model Name R-Series
b = Housing Version: P = Profile / H = Hydraulic Rod
c = Rod Version: M = Flange M18 × 1.5 or S = ¾"- 16 UNF-3A or B = basic unit
 Profile Version: S = Captive sliding magnet with ball joint at top or V = Captive sliding magnet with ball joint at front or M = U- Magnet
defgM = Measuring Length in millimeter (RP: 50...1650 mm / RH: 50...6000 mm*)
hij = Connection Type: P = PUR cable K26 with length in meter or D60 = connector 6 pin male receptacle M16 or D62 = 2 x connector 6 pin male receptacle M16 or D51 = connector 5 pin male receptacle M12 or D31 = 5 pol. male connector M12
1 = Excitation input voltage (+24 V)
C = CANBus Interface
klm = Protocol: 101 = CANbasic (MTS) or 207 = Multi-Position measurement or 304 = CANopen
n = Baud rate: 1 = 1000 kbit/s or 2 = 500 kbit/s or 3 = 250 kbit/s or 4 = 125 kbit/s
o = Resolution: 1 = 5µm or 2 = 2µm
p = Type: 1 = Standard; 3 = customized
qr = EX = ATEX approved

R Series: SSI

RX-X-XXXXM-XXX-1-S-XXXXXX-EX
ab-c-defgM-hij-1-S-klmnop-qr

Where,

a = Model Name R-Series
b = Housing Version: P = Profile / H = Hydraulic Rod
c = Rod Version: M = Flange M18 × 1.5 or S = ¾"- 16 UNF-3A or B = basic unit
 Profile Version: S = Captive sliding magnet with ball joint at top or V = Captive sliding magnet with ball joint at front or M = U- Magnet
defgM = Measuring Length in millimeter (RP: 50...1650 mm / RH: 50...6000 mm*)
hij = Connection Type: P = PUR cable K26 with length in meter or D70 = connector 7 pin male receptacle M16
1 = Excitation input voltage (+24 V)
S = Synchronous Serial Interface (SSI)
k = Data length: 1 = 25 bit or 2 = 24 bit or 3 = 26 bit
l = Output format: B – Binary or G – Gray
m = Resolution (mm): 1 = 0,005 or 2 = 0,01 or 3 = 0,05 or 4 = 0,1 or 5 = 0,02 or 6 = 0,002 or 8 = 0,001
n = Performance: 1 = Standard
op = Options: 00 = Measuring direction forward or 01 = Measuring direction reverse or 02 = Measuring direction forward, synchronized measurement or 05 = Measuring direction forward, Bit 25 = Alarm, Bit 26 = Parity even
qr = EX = ATEX approved

G-Series: Analog and Start/Stop

GX-X-XXXXM-XXX-1-XXX-EX
ab-c-defgM-hij-1-klm-no

Where,

a = Model Name G-Series
b = Housing Version: P = Profile / H = Hydraulic Rod
c = Rod Version: M = Flange M18 × 1.5 or S = ¾"- 16 UNF-3A or B = basic unit
 Profile Version: S = Captive sliding magnet with ball joint at top or V = Captive sliding magnet with ball joint at front or M = U- Magnet
defgM = Measuring length in millimeter (50...1650 mm)
hij = Connection Type: H = PUR cable K59 or T = Teflon cable K34 or R = PVC cable K27 with length in meter or D60 = connector 6 pin male receptacle M16
1 = Excitation input voltage (+24 V)
klm = Analog Type Versions (Voltage or current) / Start-Stop
 V0 = 0...10 V or V1 = 10...0 V or V2 = -10...+10 V or V3 = +10...-10 V
 A0 = 4...20 mA or A1 = 20...4 mA or A2 = 0...20 mA or A3 = 20...0 mA
 R01 = Start/Stop
no = EX = ATEX approved

 Note: All the above mentioned series of sensors with the cable outlets are ATEX approved. The cable options include PUR, PVC and Teflon cables, connector options are receptacle M16. See the datasheets for the article codes.

7. Installation details

The explosion-proof sensor can be used as follows:

- a) In zone 2 (Gas, Category 3G) in the explosion groups IIA, IIB and IIC.
- b) In zone 22 (Dust, Category 3D) at dusts with a minimum ignition energy of > 3 mJ.

The qualification with regard to the surface temperature is T4; for all gases, vapours and mists with an ignition temperature >135°C the equipment is not an ignition source.

In dust-hazardous area, 101°C is the reference temperature for further considerations with regard to a safe distance from the glowing temperature (to be decided by the operator).

The execution of the construction has to be made according to the installation regulations. The relevant details of the valid standards e.g. EN 60079-14 have to be followed strictly.

The devices have to be protected against electrostatic discharge.

Potential equalization has to be established. This has to be done according to the installation regulations of the operator's country (DIN VDE 0100 Part 540 (HD 60364-5-54) respectively EN 60204-1).

It is prohibited to run the sensors in constructions with cathodic corrosion protection; exceptions have to be arranged with the manufacturer. Outer parts of the equipment made up of from light alloy and should be protected from outside impact energy, in particular in connection with rusty metal parts.

When installing cables, the strain relief should be taken into account.

Safety details

Parts being stuck (e.g. by frost or corrosion) may not be removed by force in the presence of hazardous atmosphere.

The connection cable has to be either led out of the hazardous area uncut or wired to outlets which comply with the type of protection required locally.

Application, Operation

The use of the devices is only approved for appropriate usage according to the regulations. In terms of violations of this obligation any forms of guarantee or manufacturer liability expires.

The usage in dust-hazardous area is allowed with non-conductible dust with a minimum ignition energy of > 3 mJ.

The specified environmental conditions have to be followed strictly.

The sensors may only be used in usual industrial atmosphere. In the presence of aggressive substances in the air please contact the manufacturer first.

Special attention has to be taken that no leakage currents (caused e.g. by frequency converter driven motors, welding machines and/or cathodic corrosion protection installations) are lead through the sensor.

Isolation measurements during the operating are normally not required. If required, only use energy limited DC-circuits for measuring. Otherwise the sensor may be damaged.

Expose only a minimal vibration to the sensors.

The protection against lightning has to be provided by the operator.

Assembly, Disassembly

At the assembly and disassembly follow the state-of-art technology. Especially working at electric constructions requires the compliance of special safety regulations. Some specific points for the startup:

- The device was installed according to the regulations.
- The demand for the applicable explosion category was taken into account.
- The device is not damaged.
- The place of the installation is clean.
- All screws are tightened.

Maintenance, Attendance

Definition of Expressions by EN 60079-17

Attendance and Maintenance A combination of any actions carried out to retain an item in, or restore it to, conditions in which it is able to meet the requirements of the relevant specifications and perform its required functions.

Inspection

Action comprising careful scrutiny of an item carried out either without dismantling, or with the addition of partial dismantling as required, supplemented by means such as measurement, in order to arrive at a reliable conclusion as to the condition of an item.

Visual inspection

Inspection which identifies, without the use of access equipment or tools, those defects, such as missing bolts, which will be apparent to the eye.

Close inspection

Inspection which encompasses those aspects covered by a visual inspection and, in addition, identifies those defects, such as loose bolts, which will be apparent only by the use of access equipment, for example steps, (where necessary), and tools. Close inspections do not normally require the enclosure to be opened, or the equipment to be deenergized.

Detailed inspection

Inspection which encompasses those aspects covered by a close inspection and, in addition, identifies those defects, such as loose terminations, which will only be apparent by opening the enclosure, and/or using, where necessary, tools and test equipment.

Maintenance actions have to be carried out by qualified employees of MTS or by personnel with special training through MTS.

In ex-hazardous area only accessories, which meet the requirements of the European guidelines and the national law, are allowed to be used.

Maintenance actions implying dismantling of the machine have to be effected with the absence of hazardous atmosphere.

The replacement of components has to be made only with original spare parts, which are approved for the use in ex-hazardous area. This also applies for lubricants and auxiliary material.

The devices in ex-hazardous area have to be maintained and cleaned regular intervals. The intervals are defined by the operator according to the environmental demands on the location.

After maintenance and/or attendance all barriers and advices have to be placed in the original state.

| Action | Visual inspection monthly | Close inspection every 6 month | Detailed inspection every 12 month |
|--|---------------------------|--------------------------------|------------------------------------|
| Visual inspection of the sensors for leak tightness, clear dust deposits | + | | |
| Check for quit operation and warming with adequate measurement equipment | + | + | |
| Check of the electrical construction for integrity and functionality | | | + |
| Check of the entire construction | Operator responsibility | | |

The transmission behaviour of the devices is stable for long time periods, periodical adjustment or similar actions can be omitted. Other major maintenance actions can also be omitted.

As soon as faulty behaviour of the device is detected, remove the device or the affected assembly group. Inner parts or the electronics of the devices can not be maintained by the customer. If necessary send the device to the local representative, to get maintenance and/or repair services by the manufacturer.

Repairs by the customer are not permitted.

Fault Clearance

No Modifications of the devices are allowed.

Disposal

The disposal of the packaging materials and used parts has to take place under the regulations of the country in which the device is installed.



Sensor with Ex approval

UNITED STATES 3001 Sheldon Drive
MTS Systems Corporation Cary, N.C. 27513
Sensors Division Phone: +1 919 677-0100
Americas & APAC Region E-mail: info.us@mtssensors.com

GERMANY Auf dem Schüffel 9
MTS Sensor Technologie 58513 Lüdenscheid
GmbH & Co. KG Phone: +49 2351 9587-0
EMEA Region & India E-mail: info.de@mtssensors.com

ITALY Phone: +39 030 988 3819
Branch Office E-mail: info.it@mtssensors.com

FRANCE Phone: +33 1 58 4390-28
Branch Office E-mail: info.fr@mtssensors.com

UK Phone: +44 79 44 15 03 00
Branch Office E-mail: info.uk@mtssensors.com

SCANDINAVIA Phone: +46 70 29 91 281
Branch Office E-mail: info.sca@mtssensors.com

CHINA Phone: +86 21 2415 1000 / 2415 1001
Branch Office E-mail: info.cn@mtssensors.com

JAPAN Phone: +81 3 6416 1063
Branch Office E-mail: info.jp@mtssensors.com

Document part number:
551596 Revision E (EN) 09/2020



www.mtssensors.com