

# Temposonics®

Magnetostrictive Linear Position Sensors

## ET SSI Data Sheet

- High operating temperature
- Compact sensor housing
- ATEX / IECEx / CEC / NEC / CCC certified



## MEASURING TECHNOLOGY

The absolute, linear position sensors provided by MTS Sensors rely on the company's proprietary Temposonics® magnetostrictive technology, which can determine positions with a high level of precision and robustness.

Each Temposonics® position sensor consists of a ferromagnetic waveguide, a position magnet, a strain pulse converter and supporting electronics. The magnet, connected to the object in motion in the application, generates a magnetic field at its location on the waveguide. A short current pulse is applied to the waveguide. This creates a momentary radial magnetic field and torsional strain on the waveguide. The momentary interaction of the magnetic fields releases a torsional strain pulse that propagates the length of the waveguide. When the ultrasonic wave reaches the end of the waveguide it is converted into an electrical signal. Since the speed of the ultrasonic wave in the waveguide is precisely known, the time required to receive the return signal can be converted into a linear position measurement with both high accuracy and repeatability.

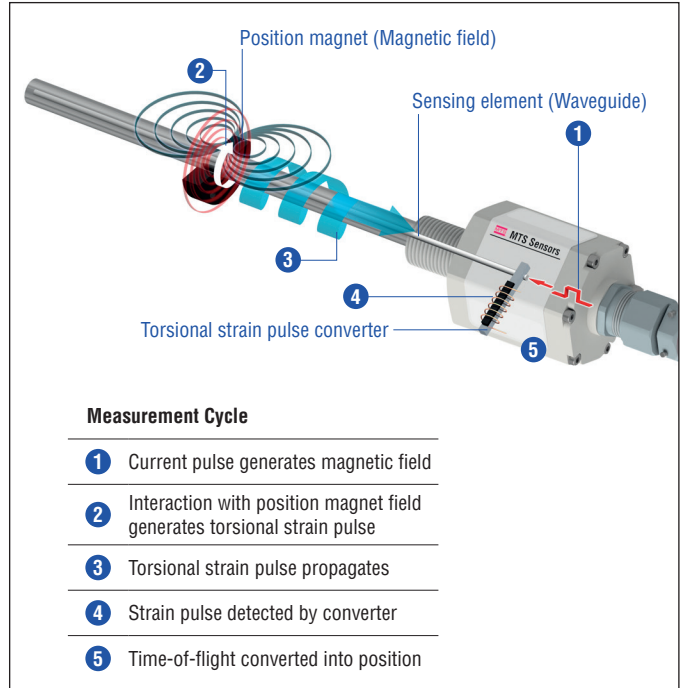

Fig. 1: Time-of-flight based magnetostrictive position sensing principle

## ET SENSOR

Robust, non-contact and wear free, the Temposonics® linear position sensors provide best durability and accurate position measurement solutions in harsh industrial environments. The position measurement accuracy is tightly controlled by the quality of the waveguide which is manufactured by MTS Sensors. The position magnet is mounted on the moving machine part and travels contactlessly over the sensor rod with the built-in waveguide.

### ET sensor specifications:

- High operating temperature up to +90 °C (+194 °F)
- Compact sensor housing
- ATEX / IECEx / CEC / NEC / CCC certified
- Configurable via programming kit

Certifications
II 3G Ex nC IIC T4 Gc
II 3D Ex tc IIIC T130 °C Dc
Class I/II/III Div 2 T4 ABCDFG
Class I Zone 2 T4 IIC
Zone 22 AEx tc T4 IIIC Dc
Ex tc IIIC T130°C Dc IP66/IP68
Ex nC IIC T4 Gc
Ex tD A22 IP66/IP68 T130°C
-40 °C ≤ Ta ≤ 90 °C; Type: 4X; IP66/IP68

Fig. 2: Certification of Temposonics® ET (version A and E)



Fig. 3: Typical application: Metal processing

## TECHNICAL DATA

Output	
Interface	SSI (Synchronous Serial Interface) – Differential signal in SSI standard
Data format	Binary, gray
Data length	24 bit/25 bit
Measured value	Position
Measurement parameters	
Resolution	5 µm/10 µm/20 µm/40 µm/50 µm/100 µm
Cycle time	Up to 3.7 kHz, depending on stroke length
Linearity <sup>1</sup>	≤ ±0.02 % F.S. (minimum ±60 µm)
Repeatability	≤ ±0.005 % F.S. (minimum ±20 µm) typical
Operating conditions	
Operating temperature	–40...+90 °C (–40...+194 °F)
Humidity	90 % relative humidity, no condensation
Ingress protection	With Teflon® cable (part no. 530 112): IP66 With silicone cable (part no. 530 113): IP68 (2 bar (29 psi) @ 30 min)
Shock test	100 g (single shock), IEC standard 60068-2-27
Vibration test	Rod: 20 g/10...2000 Hz, IEC standard 60068-2-6 (excluding resonant frequencies) Profile: 15 g/10...2000 Hz, IEC standard 60068-2-6 (excluding resonant frequencies)
EMC test	Electromagnetic emission according to EN 61000-6-4 Electromagnetic immunity according to EN 61000-6-2 The sensor meets the requirements of the EU directives and is marked with <b>CE</b>
Operating pressure	Up to 350 bar (5076 psi)
Magnet movement velocity <sup>2</sup>	Any
Design/Material	
Sensor electronics housing/Flange	Stainless steel 1.4305 (AISI 303); option: Stainless steel 1.4404 (AISI 316L)
Sensor rod	Stainless steel 1.4306 (AISI 304L); option: Stainless steel 1.4404 (AISI 316L)
Sensor profile	Aluminium
Stroke length	50...3000 mm (1...118 in.)
Mechanical mounting	
Mounting position	Any
Mounting instruction	Please consult the technical drawings and the operation manual (document number: <a href="#">551889</a> )
Electrical connection	
Connection type	Cable outlet
Operating voltage	+24 VDC (–15/+20 %)
Ripple	≤ 0.28 V <sub>pp</sub>
Current consumption	90 mA typical, dependent on stroke length
Dielectric strength	700 VDC (DC ground to machine ground)
Polarity protection	Up to –30 VDC
Overvoltage protection	Up to 36 VDC

1/ With position magnet # 251 416-2

2/ If there is contact between the moving magnet including the magnet holder and the sensor rod, make sure that the maximal speed of the moving magnet is ≤ 1 m/s (ATEX requirement due to ESD [Electro Static Discharge])

## TECHNICAL DRAWING

### ET-F / -M / -S / -W, example: Version A / N

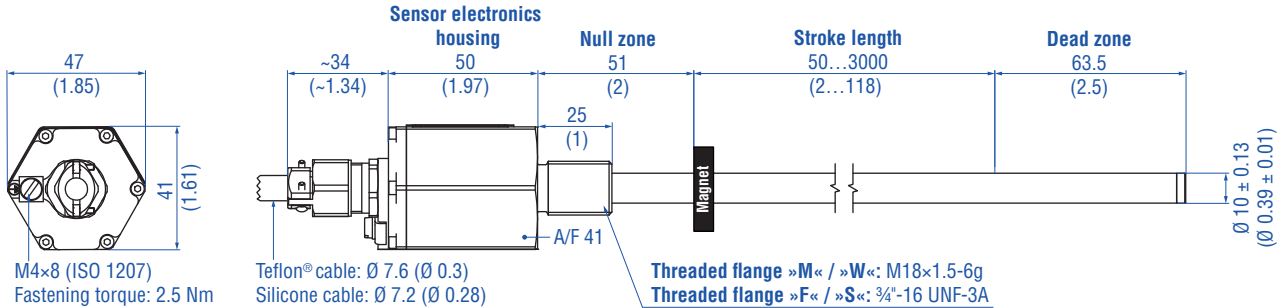

### ET-F / -M / -S / -W, example: Version E

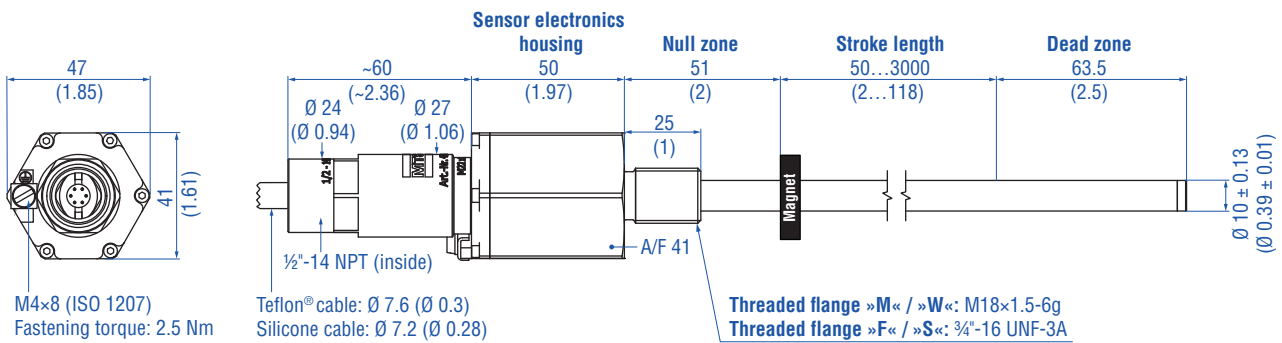

Controlling design dimensions are in millimeters and measurements in ( ) are in inches

Fig. 4: Temposonics® ET with ring magnet

### ET-P, example: Version A / N

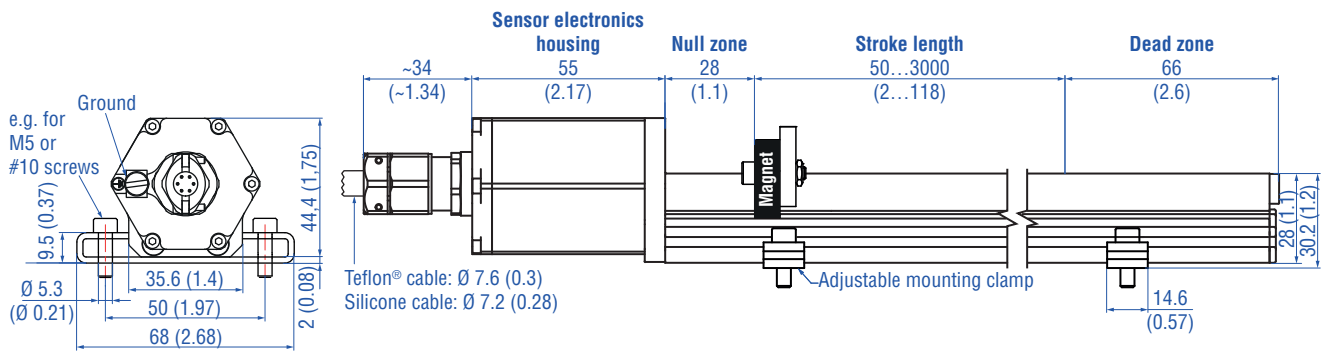

Controlling design dimensions are in millimeters and measurements in ( ) are in inches

Fig. 5: Temposonics® ET-P with U-magnet

## CONNECTOR WIRING

TXX/VXX		
Signal + power supply		
Cable	Color	Function
	GY	Data (-)
	PK	Data (+)
	YE	Clock (+)
	GN	Clock (-)
	BN	+24 VDC (-15/+20 %)
	WH	DC Ground (0 V)

Fig. 6: Connector wiring TXX / VXX

**FREQUENTLY ORDERED ACCESSORIES FOR ET-F/-W/-M/-S** – Additional options available in our [Accessories Guide](#) 551444

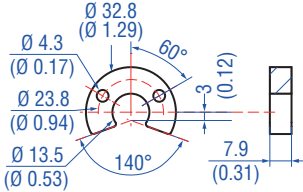
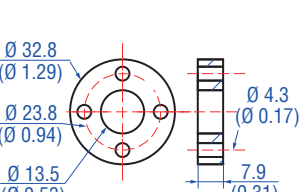
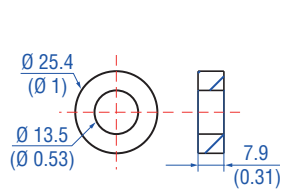
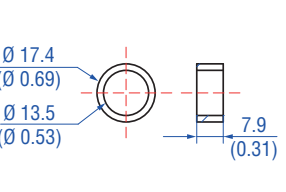
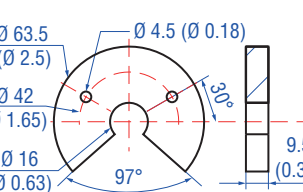
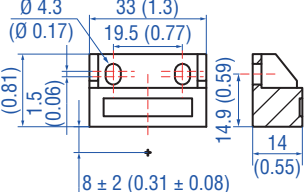
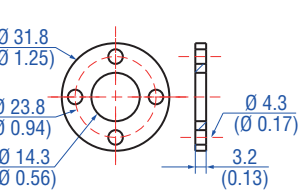
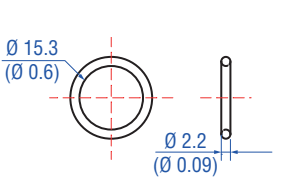
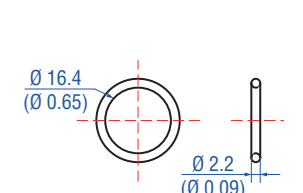
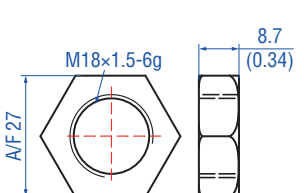
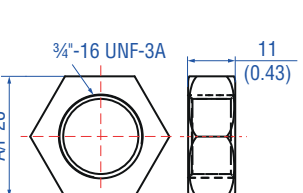
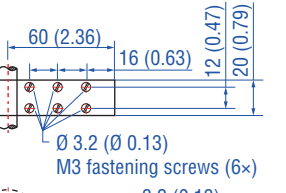
Position magnets					
					
<p><b>U-magnet OD33</b> Part no. 251 416-2</p> <p>Material: PA ferrite GF20 Weight: Approx. 11 g Surface pressure: Max. 40 N/mm<sup>2</sup> Fastening torque for M4 screws: 1 Nm Operating temperature: -40...+105 °C (-40...+221 °F)</p>	<p><b>Ring magnet OD33</b> Part no. 201 542-2</p> <p>Material: PA ferrite GF20 Weight: Approx. 14 g Surface pressure: Max. 40 N/mm<sup>2</sup> Fastening torque for M4 screws: 1 Nm Operating temperature: -40...+105 °C (-40...+221 °F)</p>	<p><b>Ring magnet OD25.4</b> Part no. 400 533</p> <p>Material: PA ferrite Weight: Approx. 10 g Surface pressure: Max. 40 N/mm<sup>2</sup> Operating temperature: -40...+105 °C (-40...+221 °F)</p>	<p><b>Ring magnet OD17.4</b> Part no. 401 032</p> <p>Material: PA neobond Weight: Approx. 5 g Surface pressure: Max. 20 N/mm<sup>2</sup> Operating temperature: -40...+105 °C (-40...+221 °F)</p>		
Position magnets		Magnet spacer		O-ring	
					
<p><b>U-magnet OD63.5</b> Part no. 201 553</p> <p>Material: PA 66-GF30, magnets compound-filled Weight: Approx. 26 g Surface pressure: 20 N/mm<sup>2</sup> Fastening torque for M4 screws: 1 Nm Operating temperature: -40...+75 °C (-40...+167 °F)</p>	<p><b>Block magnet L</b> Part no. 403 448</p> <p>Material: Plastic carrier with hard ferrite magnet Weight: Approx. 20 g Fastening torque for M4 screws: 1 Nm Operating temperature: -40...+75 °C (-40...+167 °F)</p> <p>This magnet may influence the sensor performance specifications for some</p>	<p><b>Magnet spacer</b> Part no. 400 633</p> <p>Material: Aluminum Weight: Approx. 5 g Surface pressure: Max. 20 N/mm<sup>2</sup> Fastening torque for M4 screws: 1 Nm</p>	<p><b>O-ring for threaded flange</b> M18×1.5-6g Part no. 401 133</p> <p>Material: Fluoroelastomer Durometer: 75 ± 5 Shore A Operating temperature: -40...+204 °C (-40...+400 °F)</p>		
O-ring		Mounting accessories			
					
<p><b>O-ring for threaded flange</b> ¾"-16 UNF-3A Part no. 560 315</p> <p>Material: Fluoroelastomer Durometer: 75 ± 5 Shore A Operating temperature: -40...+204 °C (-40...+400 °F)</p>	<p><b>Hex jam nut M18×1.5-6g</b> Part no. 500 018</p> <p>Material: Steel, zinc plated</p>	<p><b>Hex jam nut ¾"-16 UNF-3A</b> Part no. 500 015</p> <p>Material: Steel, zinc plated</p>	<p><b>Fixing clip</b> Part no. 561 481</p> <p>Application: Used to secure sensor rods (Ø 10 mm (Ø 0.39 in.)) when using an U-magnet or block magnet Material: Brass, non-magnetic</p>		

**FREQUENTLY ORDERED ACCESSORIES FOR ET-P** – Additional options available in our [Accessories Guide](#) 551444

**Position magnets**

<p><b>Magnet slider S, joint at top</b> Part no. 252 182</p> <p>Material: GRP, magnet hard ferrite Weight: Approx. 35 g Operating temperature: -40...+85 °C (-40...+185 °F)</p>	<p><b>Magnet slider V, joint at front</b> Part no. 252 184</p> <p>Material: GRP, magnet hard ferrite Weight: Approx. 35 g Operating temperature: -40...+85 °C (-40...+185 °F)</p>	<p><b>Magnet slider N longer ball-joint arm</b> Part no. 252 183</p> <p>Material: GRP, magnet hard ferrite Weight: Approx. 35 g Operating temperature: -40...+85 °C (-40...+185 °F)</p>	<p><b>Magnet slider G, backlash free</b> Part no. 253 421</p> <p>Material: GRP, magnet hard ferrite Weight: Approx. 25 g Operating temperature: -40...+85 °C (-40...+185 °F)</p>

**Position magnets**

**Mounting accessories**

<p><b>U-magnet OD33</b> Part no. 251 416-2</p> <p>Material: PA ferrite GF20 Weight: Approx. 11 g Surface pressure: Max. 40 N/mm<sup>2</sup> Fastening torque for M4 screws: 1 Nm Operating temperature: -40...+105 °C (-40...+221 °F)</p>	<p><b>Block magnet L</b> Part no. 403 448</p> <p>Material: Plastic carrier with hard ferrite magnet Weight: Approx. 20 g Fastening torque for M4 screws: 1 Nm Operating temperature: -40...+75 °C (-40...+167 °F)</p> <p>This magnet may influence the sensor performance specifications for some applications.</p>	<p><b>Mounting clamp</b> Part no. 400 802</p> <p>Material: Stainless steel (AISI 304)</p>	<p><b>T-nut</b> Part no. 401 602</p> <p>Fastening torque for M5 screw: 4.5 Nm</p>

**Cable**

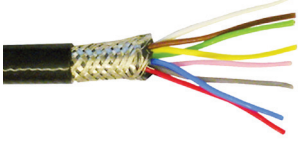

**Teflon® cable**  
**Part no. 530 112**

Name of cable in order code: **T**

Material: Teflon® jacket; black  
Features: Twisted pair, shielded, flexible  
high thermal resistance, mostly oil & acid resistant  
Cable Ø: 7.6 mm (0.3 in.)  
Cross section:  $4 \times 2 \times 0.25 \text{ mm}^2$   
Bending radius:  $8 - 10 \times D$   
(fixed installation)  
Operating temperature:  
 $-100 \dots +180 \text{ °C}$  ( $-148 \dots +356 \text{ °F}$ )

**Silicone cable**  
**Part no. 530 113**

Name of cable in order code: **V**

Material: Silicone jacket; red  
Features: Twisted pair, shielded, highly flexible, halogen free, high thermal resistance  
Cable Ø: 7.2 mm (0.28 in.)  
Cross section:  $3 \times 2 \times 0.25 \text{ mm}^2$   
Bending radius:  $5 \times D$   
(fixed installation)  
Operating temperature:  
 $-50 \dots +180 \text{ °C}$  ( $-58 \dots +356 \text{ °F}$ )

**Programming tool (Not approved for use in hazardous environments)**



**Programming kit**  
**Part no. 254 590**

Kit includes:  
1 × interface converter box,  
1 × power supply  
1 × cable (60 cm) with M12 female connector (8 pin), straight – D-sub female connector (9 pin), straight  
1 × cable (60 cm) with M16 female connector (7 pin), straight – D-sub female connector (9 pin), straight  
1 × cable (60 cm) with 6 × terminal clamp – D-sub female connector (9 pin), straight  
1 × USB cable

Software is available at:  
[www.mtssensors.com](http://www.mtssensors.com)



## ORDER CODE

1	2	3	4	5	6	7	8	9	10	11	12	13	14	15	16	17	18	19	20	
E	T										1		S							
a		b	c					d			e	f	g							

<b>a</b>	<b>Sensor model</b>
E T	Rod/Profile

<b>b</b>	<b>Design</b>
<b>ET rod-style sensor with housing and sensor rod material stainless steel 1.4404 (AISI 316L)</b>	
F	Threaded flange ¾"-16 UNF-3A
W	Threaded flange M18×1.5-6g
<b>ET rod-style sensor with housing material stainless steel 1.4305 (AISI 303) and sensor rod material stainless steel 1.4306 (AISI 304L)</b>	
M	Threaded flange M18×1.5-6g
S	Threaded flange ¾"-16 UNF-3A
<b>ET profile-style sensor with housing material stainless steel 1.4305 (AISI 303) and profile material aluminium</b>	
P	Profile

<b>c</b>	<b>Stroke length</b>
X X X X M	0050...3000 mm
<b>Standard stroke length (mm)</b>	<b>Ordering steps</b>
50... 500 mm	5 mm
500... 750 mm	10 mm
750...1000 mm	25 mm
1000...2500 mm	50 mm
2500...3000 mm	100 mm
X X X X U	002.0...118.0 in.
<b>Standard stroke length (in.)</b>	<b>Ordering steps</b>
2... 20 in.	0.2 in.
20... 30 in.	0.5 in.
30... 40 in.	1.0 in.
40...100 in.	2.0 in.
100...116 in.	4.0 in.
Non-standard stroke lengths are available; must be encoded in 5 mm / 0.1 in. increments	

<b>d</b>	<b>Connection type</b>
T X X	T01...T10 (1...10 m) XX m Teflon® cable (part no. 530 112) T03...T33 (3...33 ft) XX ft Teflon® cable (part no. 530 112)
V X X	V01...V10 (1...10 m) XX m silicone cable (part no. 530 113) V03...V33 (3...33 ft) XX ft silicone cable (part no. 530 113)
Encode in meters if using metric stroke length. Encode in feet if using US customary stroke length.	

<b>e</b>	<b>Operating voltage</b>
1	+24 VDC (-15/+20 %)

<b>f</b>	<b>Version (see "Certification of Temposonics® ET (version A and E)" on page 2 for further information)</b>
A	ATEX / IECEx / CEC / NEC
E	ATEX / IECEx / CEC / NEC with ½" NPT adapter
N	Not approved

<b>NOTICE</b>
Version E (section <b>f</b> ) is only available with design »M« and »S« (section <b>b</b> ).

**g** see next page!

g Output	
<b>S (15) (16) (17) (18) (19) (20)</b> = Synchronous Serial Interface	
<b>Data length (box no. 15)</b>	
<b>1</b>	25 bit
<b>2</b>	24 bit
<b>Output format (box no. 16)</b>	
<b>B</b>	Binary
<b>G</b>	Gray
<b>Resolution (box no. 17)</b>	
<b>0</b>	0.04 mm (40 µm)
<b>1</b>	0.005 mm (5 µm)
<b>2</b>	0.01 mm (10 µm)
<b>3</b>	0.05 mm (50 µm)
<b>4</b>	0.1 mm (100 µm)
<b>5</b>	0.02 mm (20 µm)
<b>Filtering performance (box no. 18)</b>	
<b>1</b>	No filter
<b>2</b>	Average filter 2
<b>3</b>	Average filter 4
<b>4</b>	Average filter 8
<b>Signal options (box no. 19, 20)</b>	
<b>0 0</b>	Measuring direction forward, asynchronous mode
<b>0 1</b>	Measuring direction reverse, asynchronous mode
<b>0 2</b>	Measuring direction forward, synchronous mode
<b>0 3</b>	Measuring direction reverse, synchronous mode

## DELIVERY

-  **ET-F/-W/-M/-S (rod sensor):** Accessories have to be ordered separately.
- Sensor
- ET-P (profile sensor):**
- Sensor
  - 2 mounting clamps up to 1250 mm (50 in.) stroke length + 1 mounting clamp for each 500 mm (20 in.) additional stroke length

### NOTICE

Use magnets of the same type for multi-position measurement, e.g. 2 × U-magnet (part no. 251 416-2).

**UNITED STATES** 3001 Sheldon Drive  
**MTS Systems Corporation** Cary, N.C. 27513  
**Sensors Division** Phone: +1 919 677-0100  
Americas & APAC Region E-mail: info.us@mtssensors.com

**GERMANY** Auf dem Schüffel 9  
**MTS Sensor Technologie** 58513 Lüdenscheid  
**GmbH & Co. KG** Phone: +49 2351 9587-0  
EMEA Region & India E-mail: info.de@mtssensors.com

**ITALY** Phone: +39 030 988 3819  
Branch Office E-mail: info.it@mtssensors.com

**FRANCE** Phone: +33 1 58 4390-28  
Branch Office E-mail: info.fr@mtssensors.com

**UK** Phone: +44 79 44 15 03 00  
Branch Office E-mail: info.uk@mtssensors.com

**SCANDINAVIA** Phone: +46 70 29 91 281  
Branch Office E-mail: info.sca@mtssensors.com

**CHINA** Phone: +86 21 2415 1000 / 2415 1001  
Branch Office E-mail: info.cn@mtssensors.com

**JAPAN** Phone: +81 3 6416 1063  
Branch Office E-mail: info.jp@mtssensors.com

**Document Part Number:**  
551899 Revision D (EN) 05/2021



[www.mtssensors.com](http://www.mtssensors.com)