

# Temposonics®

Magnetostrictive Linear Position Sensors



Sensor with Ex approval

**ET SSI ATEX/IECEX/CEC/NEC/CCC Certified**  
Operation Manual



## Table of contents

<b>1. Introduction</b>	<b>3</b>
1.1 Purpose and use of this manual	3
1.2 Used symbols and warnings	3
<b>2. Safety instructions</b>	<b>3</b>
2.1 Intended use	3
2.2 Foreseeable misuse	3
2.3 Installation, commissioning and operation	4
2.4 Safety instructions for use in explosion-hazardous areas	5
2.5 Warranty	5
2.6 Return	5
<b>3. Identification</b>	<b>6</b>
3.1 Order code Temposonics® ET	6
3.2 Nameplate (example)	7
3.3 Approvals	7
3.4 Scope of delivery	7
<b>4. Product description and commissioning</b>	<b>7</b>
4.1 Functionality and system design	7
4.2 Styles and installation of Temposonics® ET (rod style)	8
4.3 Styles and installation of Temposonics® ET (profile style)	10
4.4 Magnet installation	11
4.5 Electrical connection	12
4.6 Frequently ordered accessories for ET-F/-W/-M/-S	14
4.7 Frequently ordered accessories for ET-P	15
4.8 Frequently ordered accessories for SSI output	16
<b>5. Operation</b>	<b>17</b>
5.1 Getting started	17
5.2 Programming and configuration	17
<b>6. Maintenance and troubleshooting</b>	<b>21</b>
6.1 Error conditions, troubleshooting	21
6.2 Maintenance	21
6.3 Repair	21
6.4 List of spare parts	21
6.5 Transport and storage	21
<b>7. Removal from service / dismantling</b>	<b>21</b>
<b>8. Technical data of Temposonics® ET</b>	<b>22</b>
<b>9. Appendix</b>	<b>24</b>
<b>10. Declaration of conformity</b>	<b>25</b>

## 1. Introduction

### 1.1 Purpose and use of this manual

Before starting the operation of Temposonics® position sensors read this documentation thoroughly and follow the safety information. Keep the manual for future reference!

The content of this technical documentation and of its appendix is intended to provide information on mounting, installation and commissioning by qualified automation personnel <sup>1</sup> or instructed service technicians who are familiar with the project planning and dealing with Temposonics® sensors.

### 1.2 Used symbols and warnings

Warnings are intended for your personal safety and for avoidance of damage to the described product or connected devices. In this documentation, safety information and warnings to avoid danger that might affect the life and health of operating as well as service personnel or cause material damage are highlighted by the preceding pictogram, which is defined below.

Symbol	Meaning
<b>NOTICE</b>	This symbol is used to point to situations that may lead to material damage, but not to personal injury.

## 2. Safety instructions

### 2.1 Intended use

This product may be used only for the applications defined under item 1 to item 4 and only in conjunction with the third-party devices and components recommended or approved by MTS Sensors. As a prerequisite of proper and safe operation, the product requires correct transport, storage, mounting and commissioning and must be operated with utmost care.

1. The sensor systems of all Temposonics® series are intended exclusively for measurement tasks encountered in industrial, commercial and laboratory applications. The sensors are considered as system accessories and must be connected to suitable evaluation electronics, e.g. a PLC, IPC, indicator or other electronic control unit.
2. The sensor's surface temperature class is T4.
3. The ATEX, IECEX, CEC, NEC and CCC certificates have to be taken into account, including any special conditions defined therein, as well as chapter "2.3 Installation, commissioning and operation" on page 4.

<sup>1/</sup> The term qualified technical personnel characterizes persons who:

- are familiar with the safety concepts of automation technology applicable to the particular project
- are competent in the field of electromagnetic compatibility (EMC)

4. The position sensor may be used in hazardous areas according to Fig. 34. Any use of this product outside of these approved areas will void the warranty and all manufacturer's product responsibilities and liabilities. For non-hazardous areas MTS Sensors recommends to use the version N (not approved).

Zone	Explosion group
Zone 2 (Gas-Ex, category 3G, EPL Gc)	IIA, IIB and IIC
Zone 22 (Dust-Ex, category 3D, EPL Dc)	IIIA, IIIB and IIIC

Class	Group
Class I (Gas, Division 2)	A, B, C, D
Class II / III (Dust, Division 2)	F, G

### 2.2 Forseeable misuse

Forseeable misuse	Consequence
Lead compensating currents through the enclosure	The sensor will be damaged
Wrong sensor connection	The sensor will not work properly or will be destroyed
Operate the sensor out of the operating temperature range	No signal output The sensor can be damaged
Power supply is out of the defined range	Signal output is wrong / no signal output / the sensor will be damaged
Position measurement is influenced by an external magnetic field	Signal output is wrong
Cables are damaged	Short circuit – the sensor can be destroyed / sensor does not respond
Spacers are missing / are installed in a wrong order	Error in position measurement
Wrong connection of ground / shield	Signal output is disturbed The electronics can be damaged
Use of a magnet that is not certified by MTS Sensors	Error in position measurement

- have received adequate training for commissioning and service operations
- are familiar with the operation of the device and know the information required for correct operation provided in the product documentation

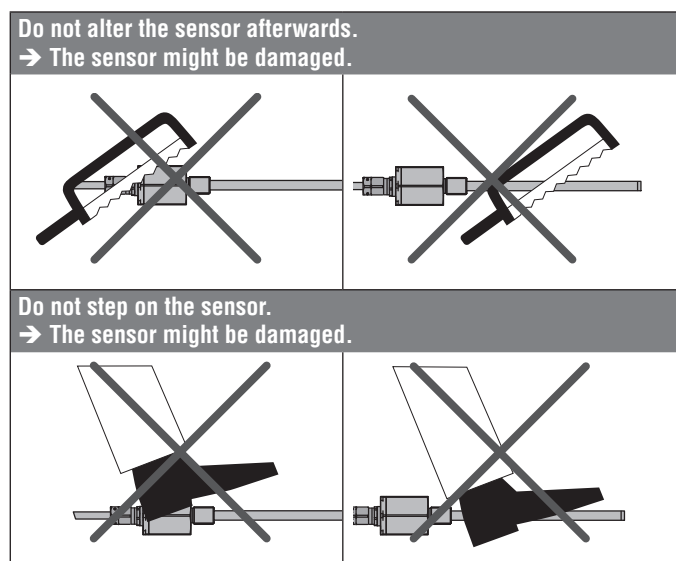

### 2.3 Installation, commissioning and operation

The position sensors must be used only in technically safe condition. To maintain this condition and to ensure safe operation, installation, connection and service, work may be performed only by qualified technical personnel, according to IEC 60079-14, IEC 60079-17, TRBS 1203, Canadian Electrical Code (CEC), National Electrical Code (NEC) and local regulations.

If danger of injury to persons or of damage to operating equipment is caused by sensor failure or malfunction, additional safety measures such as plausibility checks, limit switches, EMERGENCY STOP systems, protective devices etc. are required. In the event of trouble, shut down the sensor and protect it against accidental operation.

#### Safety instructions for commissioning

To maintain the sensor's operability, it is mandatory to follow the instructions given below.

1. Follow the specifications given in the technical data.
2. Ensure that equipment and associated components used in a hazardous environment are selected and installed in compliance with regulations governing the geographical location and facility. Only install equipment that complies with the types of protection relevant to the applicable Zones and Categories.
3. In explosive atmospheres use only such auxiliary components that meet all requirements of the local and national standards.
4. The potential equalisation of the system has to be established according to the regulations of erection applicable in the respective country of use (VDE 0100, part 540; IEC 364-5-54).
5. Sensors from MTS Sensors are approved only for the intended use in industrial environments (see chapter "2.1 Intended use" on page 3). Contact the manufacturer for advice, if aggressive substances are present in the sensor environment.
6. Measures for lightning protection have to be taken by the user.
7. The user is responsible for the mechanical protection of the sensor.

8. The cable gland of the sensor must be protected against any external impact energy exceeding 4 J. The maximum thermal load of the cables must be taken into account.
9. The user is responsible for meeting all safety conditions as outlined by:
  - Installation instructions
  - Local prevailing standards and regulations
10. Any parts of the equipment which got stuck (e.g. by frost or corrosion) may not be removed by force if potentially explosive atmosphere is present.
11. The formation of ice on the equipment has to be prevented.
12. It is not allowed to open the sensor.
13. The connecting cable has to be either led out of the hazardous area uncut or wired to outlets which comply with the type of protection required locally.
14. The surface temperatures of equipment parts must be kept clearly below the ignition temperature of the foreseeable air / dust mixtures in order to prevent the ignition of suspended dust.

#### How to ensure safe commissioning

1. Protect the sensor against mechanical damage during installation and operation.
2. Do not use damaged products and secure them against unintentional commissioning. Mark damaged products as being defective.
3. Prevent electrostatic charges.
4. Do not use the sensor in cathodic systems for corrosion protection. Do not led parasitic currents via the construction.
5. Switch off the supply voltage prior to disconnecting or connecting the equipment.
6. Connect the sensor very carefully and pay attention to the polarity of connections, power supply as well as where appropriate to the shape and duration of control pulses.
7. Use only approved power supplies.
8. Ensure that the specified permissible limit values of the sensor for supply voltage, environmental conditions, etc. are met.
9. Make sure that:
  - the sensor and associated components were installed according to the instructions
  - the sensor enclosure is clean
  - the magnet does not grind on the rod. This could cause damage to the magnet and the sensor rod. If there is contact between the moving magnet including the magnet holder and the sensor rod, make sure that the maximal speed of the moving magnet is less or equal 1 m/s.
10. Ground the sensor via the ground lug. Both the sensor and the moving magnet including magnet holder must be connected to protective ground (PE) to avoid electrostatic discharge (ESD).
11. Before applying power, ensure that nobody's safety is jeopardized by starting machines.
12. Check the function of the sensor regularly and provide documentation of the checks.  
(see chapter "6.2 Maintenance" on page 21).

## 2.4 Safety instructions for use in explosion-hazardous areas

The sensor has been designed for operation inside explosion-hazardous areas. It has been tested and left the factory in a condition in which it is safe to operate. Relevant regulations and European standards as well as Canadian and North American standards have been observed. According to Ex marking (see chapter “2.1 Intended use” on page 3) and the ATEX, IECEX, CEC, NEC and CCC certificates (attached to this document), the sensor is approved only for operation in defined hazardous areas.

## 2.5 Warranty

MTS Sensors grants a warranty period for the Temposonics® position sensors and supplied accessories relating to material defects and faults that occur despite correct use in accordance with the intended application<sup>2</sup>. The MTS Sensors obligation is limited to repair or replacement of any defective part of the unit. No warranty can be provided for defects that are due to improper use or above average stress of the product, as well as for wear parts. Under no circumstances will MTS Sensors accept liability in the event of offense against the warranty rules, no matter if these have been assured or expected, even in case of fault or negligence of the company. MTS Sensors explicitly excludes any further warranties. Neither the company's representatives, agents, dealers nor employees are authorized to increase or change the scope of warranty.

## 2.6 Return

For diagnostic purposes, the sensor can be returned to MTS Sensors. Any shipment cost is the responsibility of the sender<sup>2</sup>. For a corresponding form, see chapter “9. Appendix” on page 24.

### NOTICE

When returning sensors, place protective caps on male and female connectors of the sensor. For pigtail cables, place the cable ends in a static shielding bag for electrostatic discharge (ESD) protection. Fill the outer packaging around the sensor completely to prevent damage during transport.

2/ See also applicable MTS Sensors terms of sales and delivery on [www.mtssensors.com](http://www.mtssensors.com)

### 3. Identification

#### 3.1 Order code Temposonics® ET

1	2	3	4	5	6	7	8	9	10	11	12	13	14	15	16	17	18	19	20
E	T										1		S						
a		b	c					d			e	f	g						

<b>a</b>	<b>Sensor model</b>
E T	Rod/Profile

<b>b</b>	<b>Design</b>
<b>ET rod-style sensor with housing and sensor rod material stainless steel 1.4404 (AISI 316L)</b>	
F	Threaded flange ¾"-16 UNF-3A
W	Threaded flange M18×1.5-6g
<b>ET rod-style sensor with housing material stainless steel 1.4305 (AISI 303) and sensor rod material stainless steel 1.4306 (AISI 304L)</b>	
M	Threaded flange M18×1.5-6g
S	Threaded flange ¾"-16 UNF-3A
<b>ET profile-style sensor with housing material stainless steel 1.4305 (AISI 303) and profile material aluminium</b>	
P	Profile

<b>c</b>	<b>Stroke length</b>
X X X X M	0050...3000 mm
<b>Standard stroke length (mm)      Ordering steps</b>	
50... 500 mm	5 mm
500... 750 mm	10 mm
750...1000 mm	25 mm
1000...2500 mm	50 mm
2500...3000 mm	100 mm
X X X X U	002.0...118.0 in.
<b>Standard stroke length (in.)      Ordering steps</b>	
2... 20 in.	0.2 in.
20... 30 in.	0.5 in.
30... 40 in.	1.0 in.
40...100 in.	2.0 in.
100...116 in.	4.0 in.
Non-standard stroke lengths are available; must be encoded in 5 mm / 0.1 in. increments	

<b>d</b>	<b>Connection type</b>
T X X	T01...T10 (1...10 m) <sup>1</sup> XX m Teflon® cable (part no. 530 112) T03...T33 (3...33 ft) <sup>2</sup> XX ft Teflon® cable (part no. 530 112)
V X X	V01...V10 (1...10 m) <sup>1</sup> XX m silicone cable (part no. 530 113) V03...V33 (3...33 ft) <sup>2</sup> XX ft silicone cable (part no. 530 113)
<sup>1</sup> Encode in meters if using metric stroke length.	
<sup>2</sup> Encode in feet if using US customary stroke length.	

<b>e</b>	<b>Operating voltage</b>
1	+24 VDC (-15/+20 %)

<b>f</b>	<b>Version (see "Certification of Temposonics® ET (version A and E)" on page 26 for further information)</b>
A	ATEX/IECEX/CEC/NEC/CCC
E	ATEX/IECEX/CEC/NEC/CCC with ½" NPT adapter
N	Not approved

**NOTICE**  
Version E (section f ) is only available with design »M« and »S« (section b ).

<b>g</b>	<b>Output</b>
S (15) (16) (17) (18) (19) (20)	= Synchronous Serial Interface
<b>Data length (box no. 15)</b>	
1	25 bit
2	24 bit
<b>Output format (box no. 16)</b>	
B	Binary
G	Gray
<b>Resolution (box no. 17)</b>	
1	0.005 mm
2	0.01 mm
3	0.05 mm
4	0.1 mm
5	0.02 mm
<b>Filtering performance (box no. 18)</b>	
1	No filter
2	Average filter 2
3	Average filter 4
4	Average filter 8
<b>Signal options (box no. 19, 20)</b>	
0 0	Measuring direction forward, asynchronous mode
0 1	Measuring direction reverse, asynchronous mode
0 2	Measuring direction forward, synchronous mode
0 3	Measuring direction reverse, synchronous mode

### 3.2 Nameplate (example)



Fig. 1: Label of sensor for use in explosion hazardous areas



Fig. 2: Label of sensor without certification for use in explosion hazardous areas

### 3.3 Approvals

See chapter “8. Technical data of Temposonics® ET” on page 22 f.

### 3.4 Scope of delivery

#### ET-F/-W/-M/-S (rod sensor):

- Sensor

#### ET-P (profile sensor):

- Sensor
- 2 mounting clamps up to 1250 mm (50 in.) stroke length + 1 mounting clamp for each 500 mm (20 in.) additional stroke length

## 4. Product description and commissioning

### 4.1 Functionality and system design

#### Product designation

- Position sensor Temposonics® E-Series

#### Sensor model

- Temposonics® ET-F/-W/-M/-S (rod sensor)
- Temposonics® ET-P (profile sensor)

#### Stroke length

- 50...3000 mm (2...118 in.)

#### Output signal

- SSI

#### Application

Temposonics® position sensors are used for measurement and conversion of the length (position) variable in the fields of automated systems and mechanical engineering.

#### Principle of operation and system construction

The absolute, linear position sensors provided by MTS Sensors rely on the company's proprietary Temposonics® magnetostrictive technology, which can determine position with a high level of precision and robustness. Each Temposonics® position sensor consists of a ferromagnetic waveguide, a position magnet, a strain pulse converter and supporting electronics. The magnet, connected to the object in motion in the application, generates a magnetic field at its location on the waveguide. A short current pulse is applied to the waveguide. This creates a momentary radial magnetic field and torsional strain on the waveguide. The momentary interaction of the magnetic fields releases a torsional strain pulse that propagates the

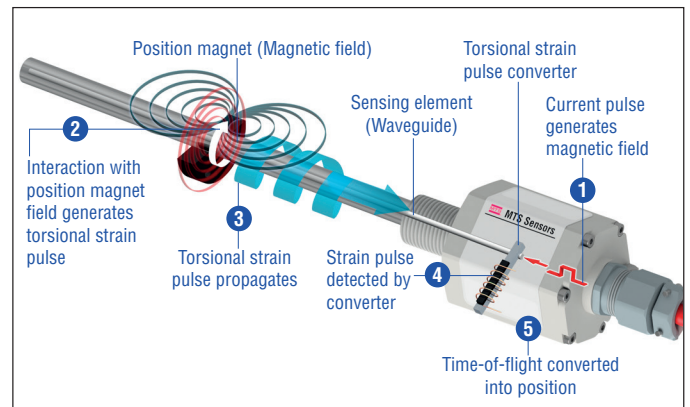

Fig. 3: Time-of-flight based magnetostrictive position sensing principle

length of the waveguide. When the ultrasonic wave reaches the end of the waveguide it is converted into an electrical signal. Since the speed of the ultrasonic wave in the waveguide is precisely known, the time required to receive the return signal can be converted into a linear position measurement with both high accuracy and repeatability.

#### Modular mechanical and electronic construction

- The sensor rod protects the inner sensor element.
- The sensor electronics housing, a rugged stainless steel construction, contains the complete electronic interface with active signal conditioning.
- The external position magnet is a permanent magnet. Mounted on the mobile machine part, it travels along the sensor rod and triggers the measurement through the sensor rod wall.
- The sensor can be connected directly to a control system. Its electronics generates a strictly position proportional signal output between start and end position.



## 4.2 Styles and installation of Temposonics® ET (rod sensor)

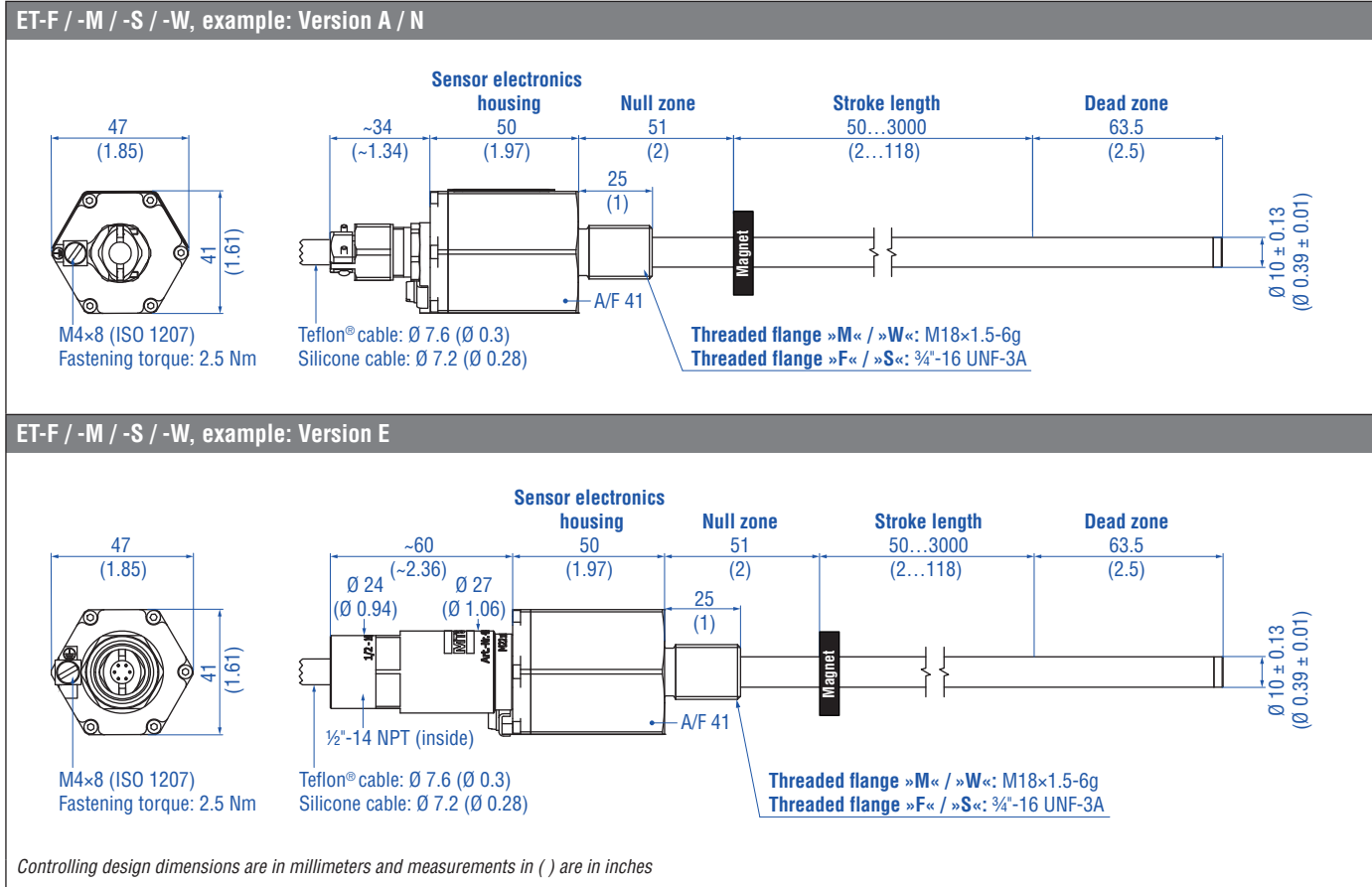

Fig. 4: Temposonics® ET with ring magnet

### Installation of ET with threaded flange »F«, »M«, »S« & »W«

Fix the sensor rod via threaded flange M18x1.5-6g or ¼"-16 UNF-3A. Lightly oil the thread before tightening.

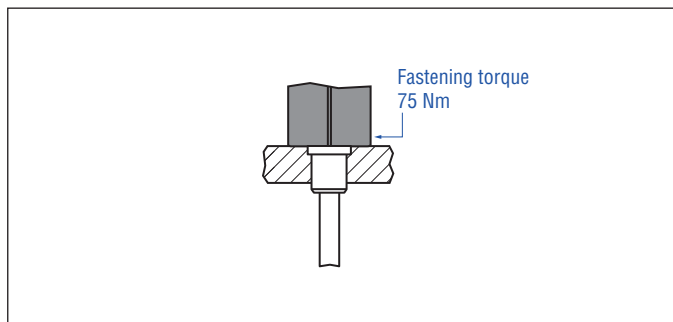

Fig. 5: Mounting example of threaded flange »F«, »M«, »S«, »W«

### Installation of a rod-style sensor in a fluid cylinder

The rod-style version has been developed for direct stroke measurement in a fluid cylinder. Mount the sensor via threaded flange or a hex nut.

- Mounted on the face of the piston, the position magnet travels over the rod without touching it and indicates the exact position through the rod wall – independent of the hydraulic fluid.
- The pressure resistant sensor rod is installed into a bore in the piston rod.

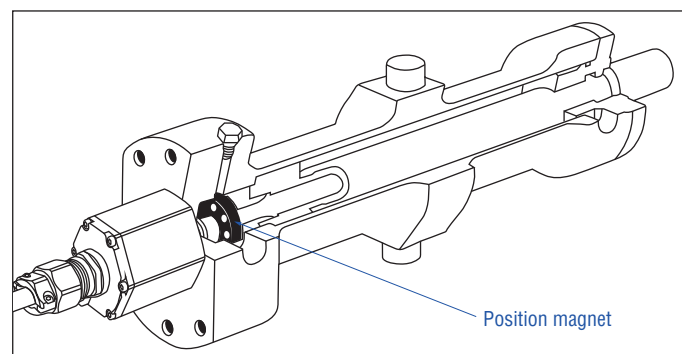

Fig. 6: Sensor in cylinder



### Hydraulics sealing

There are two ways to seal the flange contact surface (Fig. 7):

1. A sealing by using an O-ring (e.g. 22.4 × 2.65 mm (0.88 × 0.1 in.), 25.07 × 2.62 mm (0.99 × 0.1 in.)) in a cylinder end cap groove.
2. A sealing by using an O-ring in the undercut.

For threaded flange (3/4"-16 UNF-3A) »F« / »S«:

O-ring 16.4 × 2.2 mm (0.65 × 0.09 in.) (part no. 560 315)

For threaded flange (M18×1.5-6g) »M« / »W«:

O-ring 15.3 × 2.2 mm (0.60 × 0.09 in.) (part no. 401 133)

In the case of threaded flange M18×1.5-6g provide a screw hole based on ISO 6149-1 (Fig. 8). See ISO 6149-1 for further information.

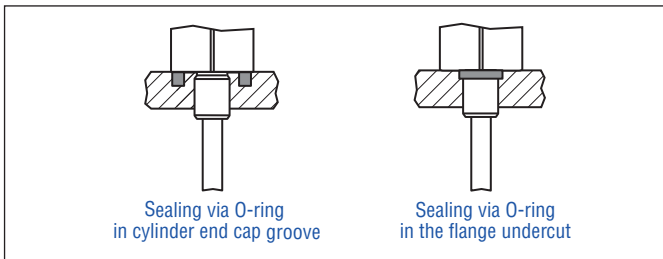

Fig. 7: Possibilities of sealing

- Note the fastening torque of 75 Nm.
- Seat the flange contact surface completely on the cylinder mounting surface.
- The cylinder manufacturer determines the pressure-resistant gasket (copper gasket, O-ring, etc.).
- The position magnet should not grind on the sensor rod.
- The piston rod drilling ( $\geq \varnothing 13$  mm ( $\geq \varnothing 0.51$  in.)) depends on the pressure and piston speed.
- Adhere to the information relating to operating pressure.
- Protect the sensor rod against wear.

### Notice for metric threaded flanges

Thread ( $d_1 \times P$ )	$d_2$	$d_3$	$d_4$	$d_5$ +0.1 0	$L_1$ +0.4 0	$L_2$	$L_3$	$L_4$	$Z^\circ$ $\pm 1^\circ$
M18×1.5-6g	55	$\geq 13$	24.5	19.8	2.4	28	2	$\geq 25.5$	15°

All dimensions in mm

Fig. 8: Notice for metric threaded flange M18×1.5-6g based on DIN ISO 6149-1

### 4.3 Styles and installation of Temposonics® ET (profile sensor)

ET-P, example: Version A / N

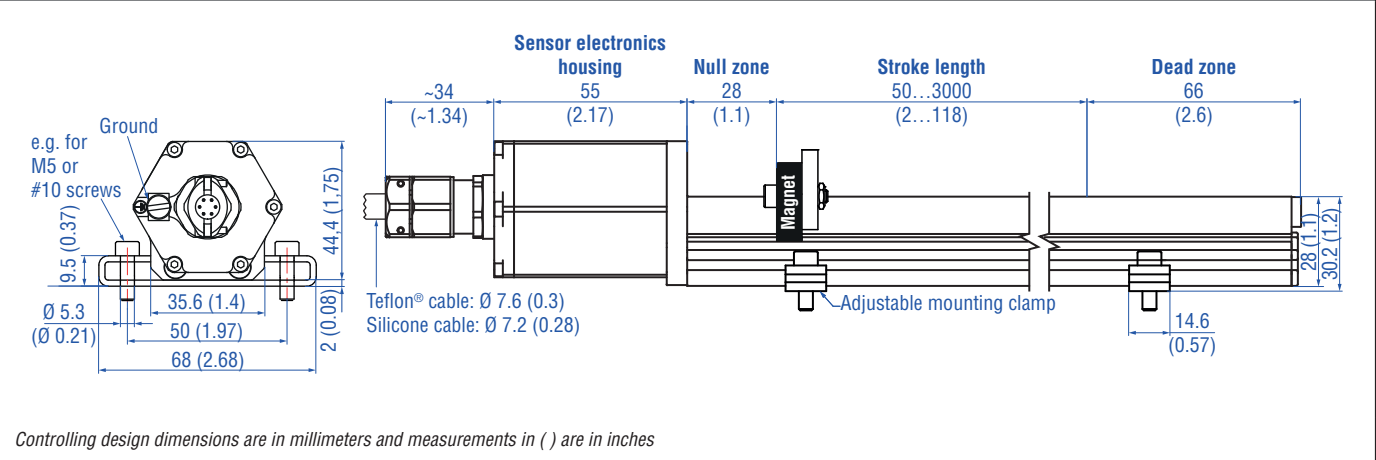

Fig. 9: Temposonics® ET (profile sensor) with U-magnet

#### Installation of ET-P (profile sensor)

The position sensor can be installed in any position. Normally, the sensor is firmly installed and the position magnet is fastened to the mobile machine part. Thus it can travel along the sensor profile. The sensor is fitted on a flat machine surface using the mounting clamps (Fig. 10). A length-dependent number of these clamps are delivered with the sensor and must be distributed over the profile at regular distances. For fastening we recommend using M5×20 screws (DIN 6912) that should be tightened with a fastening torque of 5 Nm.

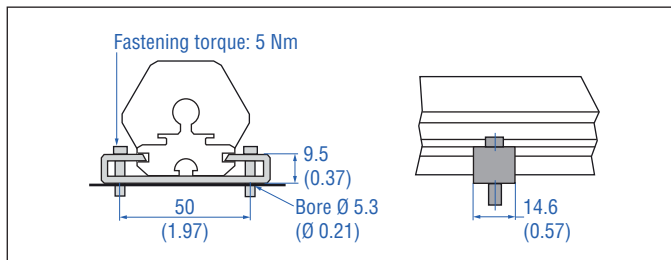

Fig. 10: Mounting clamps (part no. 400 802) with cylinder screw M5×20

#### Alternative:

If only limited space is available, the profile sensor can be mounted also via the T-rail in the profile bottom using an T-slot nut M5 (part no. 401 602) or a sliding block (Fig. 11).

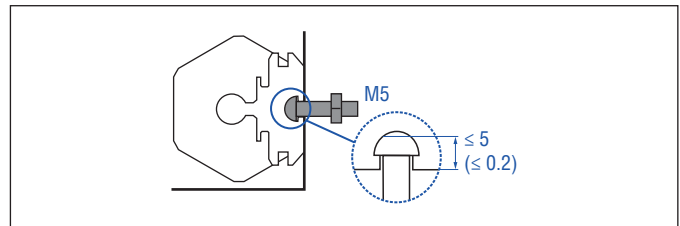

Fig. 11: T-slot nut M5 (part no. 401 602)

#### NOTICE

Take care to mount the sensor in an axially parallel position to avoid damage to magnet and sensor.

#### 4.4 Magnet installation

##### Typical use of magnets



Magnet	Typical sensors	Benefits
 <b>Ring magnets</b>	<b>Rod model</b> (ET-F/-W/-M/-S)	<ul style="list-style-type: none"> <li>Rotationally symmetrical magnetic field</li> </ul>
 <b>U-magnets</b>	<b>Profile &amp; rod models</b> (ET-P/-F/-W/-M/-S)	<ul style="list-style-type: none"> <li>Height tolerances can be compensated, because the magnet can be lifted off</li> </ul>
 <b>Block magnets</b>	<b>Profile &amp; rod models</b> (ET-P/-F/-W/-M/-S)	<ul style="list-style-type: none"> <li>Height tolerances can be compensated, because the magnet can be lifted off</li> </ul>
 <b>Magnet sliders</b>	<b>Profile models</b> (ET-P)	<ul style="list-style-type: none"> <li>The magnet is guided by the profile</li> <li>The distance between the magnet and the waveguide is strictly defined</li> <li>Easy coupling via the ball joint</li> </ul>

Fig. 12: Typical use of magnets

##### Mounting ring magnets, U-magnets & block magnets

Install the magnet using non-magnetic material for mounting device, screws, spacers etc.. The magnet must not grind on the sensor rod. Alignment errors are compensated via the air gap.

- Permissible surface pressure: Max. 40 N/mm<sup>2</sup> (only for ring magnets and U-magnets)
- Fastening torque for M4 screws: 1 Nm; use washers, if necessary
- Minimum distance between position magnet and any magnetic material has to be 15 mm (0.6 in.) (Fig. 15).
- If no other option exists and magnetic material is used, observe the specified dimensions (Fig. 15).

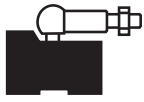
##### NOTICE

Mount ring magnets and U-magnets concentrically. Mount block magnets centrally over the sensor rod or the sensor profile. The maximum permissible air gap must not be exceeded (2.3/ Fig. 14). Take care to mount the primary sensor axis in parallel to the magnet path in order to avoid damage to the carriage, magnet and sensor rod/sensor profile.

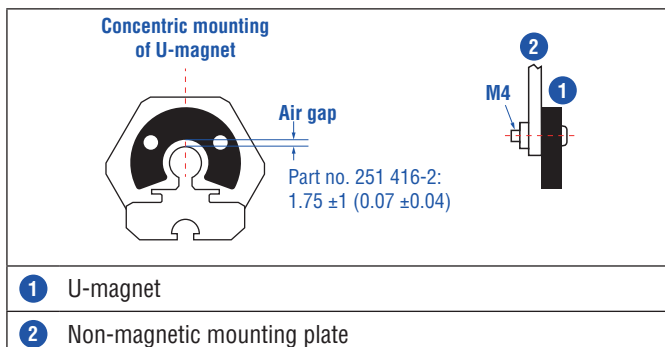

Fig. 13: Mounting of U-magnet (part no. 251 416-2 or part no. 201 553)

Controlling design dimensions are in millimeters and measurements in ( ) are in inches

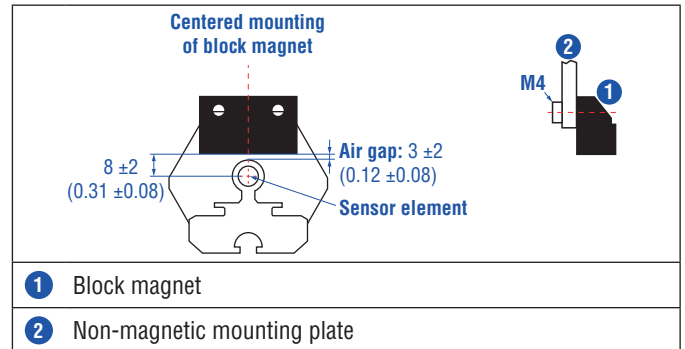

Fig. 14: Mounting of block magnet (part no. 403 448)

##### Magnet mounting with magnetic material

When using magnetic material the dimensions of page 14 must be observed.

- A.** If the position magnet aligns with the drilled piston rod
- B.** If the position magnet is set further into the drilled piston rod, install another non-magnetic spacer (e.g. part no. 400 633) above the magnet.

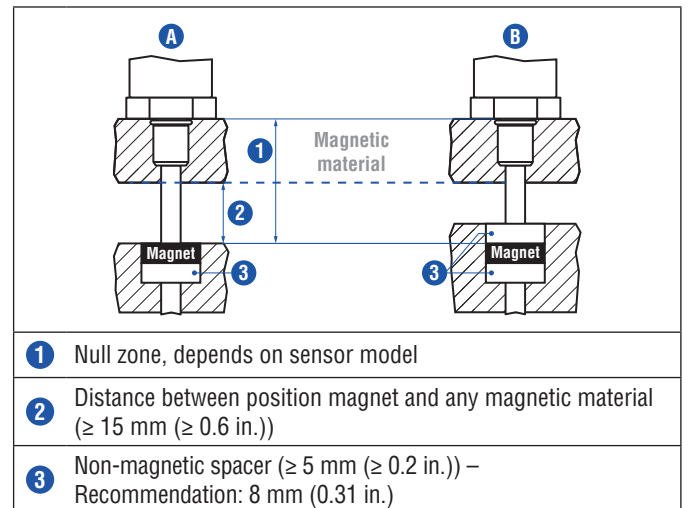

Fig. 15: Installation with magnetic material

##### Rod sensors with stroke lengths ≥ 1 meter (3.3 ft.)

Support horizontally installed sensors with a stroke length from 1 meter (3.3 ft.) mechanically at the rod end. Without the use of a support, rod and position magnet may be damaged. A false measurement result is also possible. Longer rods require evenly distributed mechanical support over the entire length (e.g. part no. 561 481). Use an U-magnet (Fig. 26) for measurement.

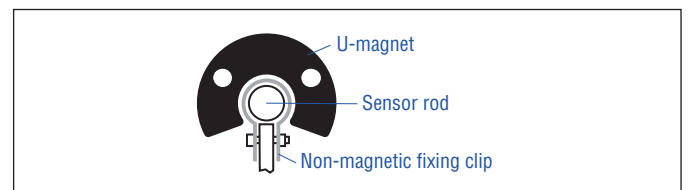

Fig. 16: Example of sensor support (part no. 561 481)

### Start and end positions of the position magnets

Consider the start and end positions of the position magnets during the installation. To ensure that the entire stroke length is electrically usable, the position magnet must be mechanically mounted as follows.

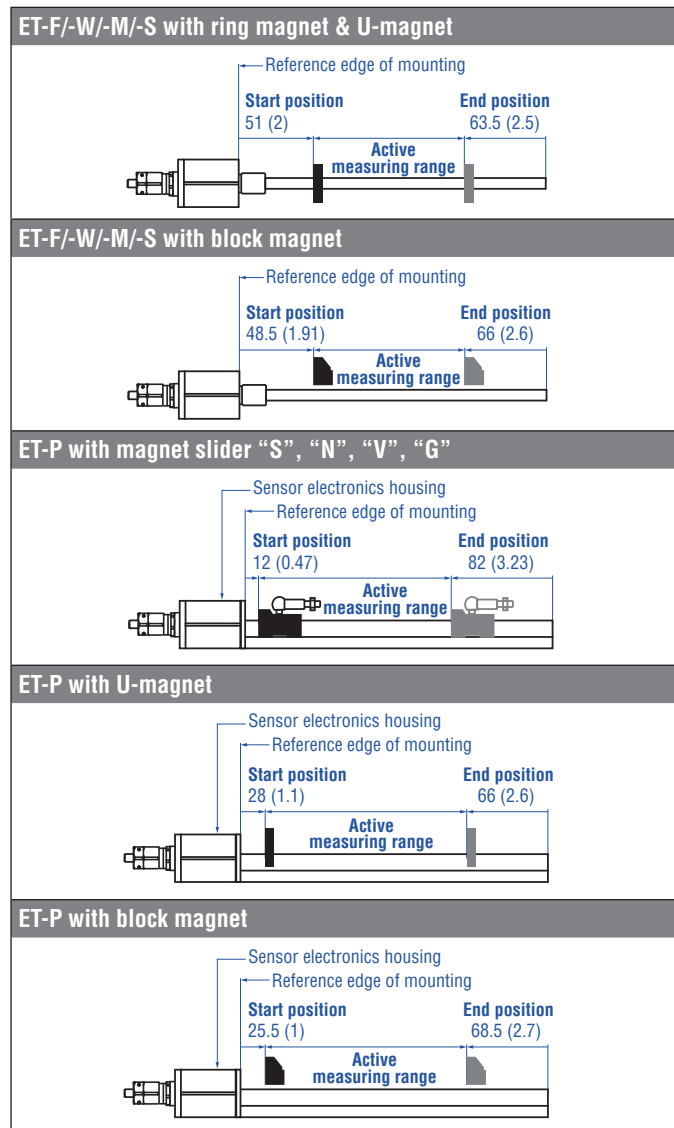

Fig. 17: Start and end positions of magnets

### NOTICE

On all sensors, the areas left and right of the active stroke length are provided for null and dead zone (see "4.2 Styles and installation of Temposonics® ET (rod style)" on page 8). These zones should not be used for measurement, however the active stroke length can be exceeded.

### Multi-position measurement

The minimum distance between the magnets is 75 mm (3 in.) (used with all types of magnets).

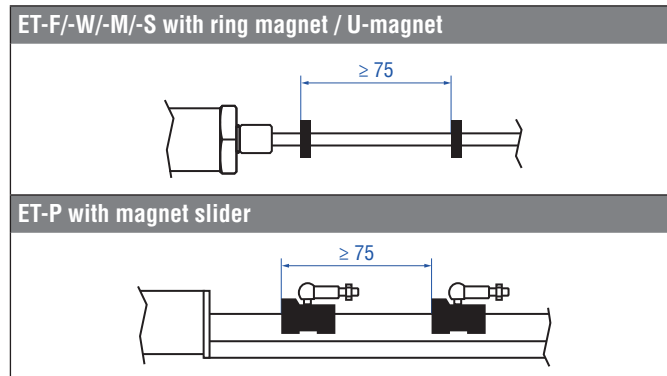

Fig. 18: Examples: Minimum distance for multi-position measurement

### NOTICE

For multi-position measurement, use magnets of the same type e.g. 2 × U-magnet (part no. 251 416-2). Do not underscore the minimum distance between the magnets of 75 mm (3 in.) for multi-position measurement. Contact MTS Sensors if you need a magnet distance < 75 mm (3 in.).

### 4.5 Electrical connection

Placement of installation and cabling have decisive influence on the sensor's electromagnetic compatibility (EMC). Hence correct installation of this active electronic system and the EMC of the entire system must be ensured by using suitable metal connectors, shielded cables and grounding. Overvoltages or faulty connections can damage the sensor electronics despite protection against wrong polarity.

### NOTICE

1. Do not mount the sensors in the area of strong magnetic or electric noise fields.
2. Never connect / disconnect the sensor when voltage is applied.

### Instruction for connection

- Connect the shield to ground externally via the controller equipment.
- Keep control and signal leads separate from power cables and sufficiently far away from motor cables, frequency inverters, valve lines, relays, etc..
- Use only connectors with metal housing, if you use a connector. Connect the shielding to the connector housing.
- Keep all non-shielded leads as short as possible.
- Keep the earth connection as short as possible with a large cross section. Avoid ground loops.
- With potential differences between machine and electronics earth connections, no compensating currents are allowed to flow across the cable shielding.  
Recommendation:  
Install potential compensating leads with large cross section.
- Use only stabilized power supplies in compliance with the specified electrical ratings.

### Grounding of rod sensors

Connect the sensor electronics housing to machine ground. Ground sensor type ET version A (with ATEX/IECEX/CEC/NEC/CCC approval) via ground lug as shown in Fig. 19. Ground the sensor type ET version N (not approved) via ground lug as shown in Fig. 19 or via thread. Ground sensor type ET version E (with ATEX/IECEX/CEC/NEC/CCC approval) via ground lug as shown in Fig. 20.

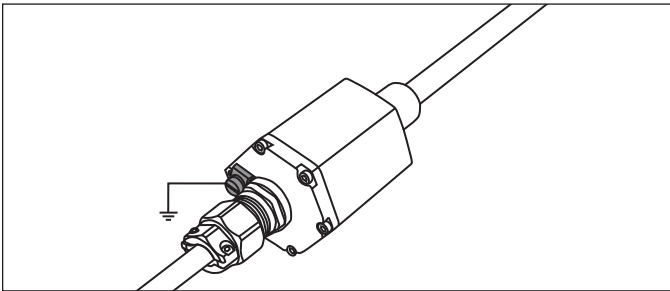

Fig. 19: Grounding via ground lug (version A, N)

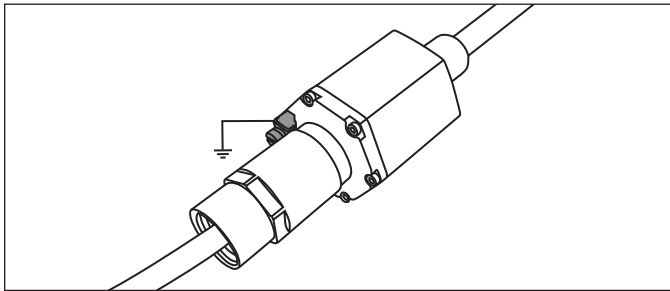

Fig. 20: Grounding via ground lug (version E)

### Connector wiring

Connect the sensor directly to the controller, indicator or other evaluating systems as follows:

TXX/VXX		
Signal + power supply		
Cable	Color	Function
	GY	Data (-)
	PK	Data (+)
	YE	Clock (+)
	GN	Clock (-)
	BN	+24 VDC (-15/+20 %)
	WH	DC Ground (0 V)

Fig. 21: Connector wiring TXX / VXX

4.6 Frequently ordered accessories – Additional options available in our [Accessories Guide](#) 551 444

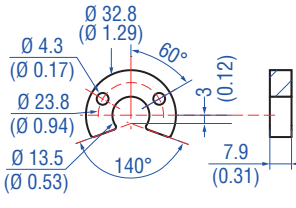
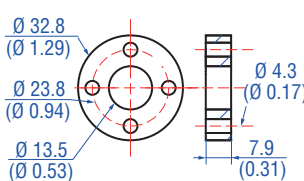
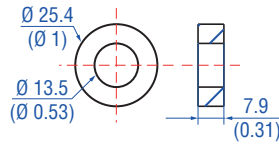
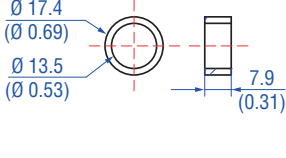
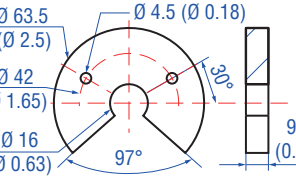
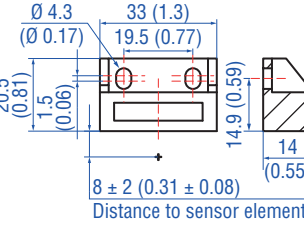
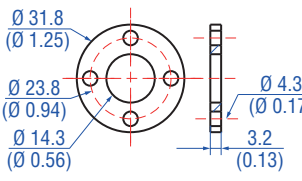
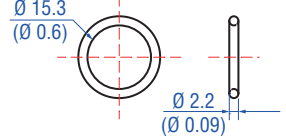
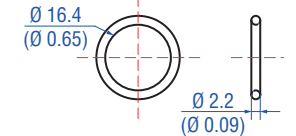
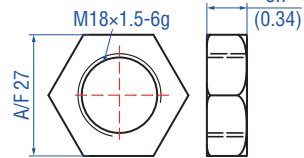
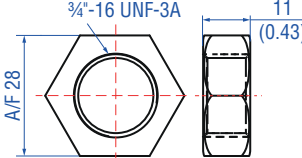
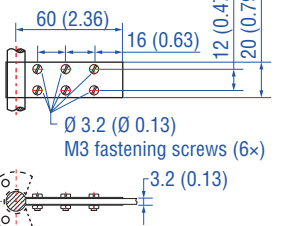
Position magnets			
 <p><b>U-magnet OD33</b>  <b>Part no. 251 416-2</b></p> <p>Material: PA ferrite GF20          Weight: Approx. 11 g          Surface pressure: Max. 40 N/mm<sup>2</sup>          Fastening torque for M4 screws: 1 Nm          Operating temperature:          -40...+105 °C (-40...+221 °F)</p>	 <p><b>Ring magnet OD33</b>  <b>Part no. 201 542-2</b></p> <p>Material: PA ferrite GF20          Weight: Approx. 14 g          Surface pressure: Max. 40 N/mm<sup>2</sup>          Fastening torque for M4 screws: 1 Nm          Operating temperature:          -40...+105 °C (-40...+221 °F)</p>	 <p><b>Ring magnet OD25.4</b>  <b>Part no. 400 533</b></p> <p>Material: PA ferrite          Weight: Approx. 10 g          Surface pressure: Max. 40 N/mm<sup>2</sup>          Operating temperature:          -40...+105 °C (-40...+221 °F)</p>	 <p><b>Ring magnet OD17.4</b>  <b>Part no. 401 032</b></p> <p>Material: PA neobond          Weight: Approx. 5 g          Surface pressure: Max. 20 N/mm<sup>2</sup>          Operating temperature:          -40...+105 °C (-40...+221 °F)</p>
Position magnets		Magnet spacer	O-ring
 <p><b>U-magnet OD63.5</b>  <b>Part no. 201 553</b></p> <p>Material: PA 66-GF30, magnets compound-filled          Weight: Approx. 26 g          Surface pressure: 20 N/mm<sup>2</sup>          Fastening torque for M4 screws: 1 Nm          Operating temperature:          -40...+75 °C (-40...+167 °F)</p>	 <p><b>Block magnet L</b>  <b>Part no. 403 448</b></p> <p>Material: Plastic carrier with hard ferrite magnet          Weight: Approx. 20 g          Fastening torque for M4 screws: 1 Nm          Operating temperature:          -40...+75 °C (-40...+167 °F)</p> <p>This magnet may influence the sensor performance specifications for some applications.</p>	 <p><b>Magnet spacer</b>  <b>Part no. 400 633</b></p> <p>Material: Aluminum          Weight: Approx. 5 g          Surface pressure: Max. 20 N/mm<sup>2</sup>          Fastening torque for M4 screws: 1 Nm</p>	 <p><b>O-ring for threaded flange</b>  <b>M18×1.5-6g</b>  <b>Part no. 401 133</b></p> <p>Material: Fluoroelastomer          Durometer: 75 ± 5 Shore A          Operating temperature:          -40...+204 °C (-40...+400 °F)</p>
O-ring		Mounting accessories	
 <p><b>O-ring for threaded flange</b>  <b>3/4"-16 UNF-3A</b>  <b>Part no. 560 315</b></p> <p>Material: Fluoroelastomer          Durometer: 75 ± 5 Shore A          Operating temperature:          -40...+204 °C (-40...+400 °F)</p>	 <p><b>Hex jam nut M18×1.5-6g</b>  <b>Part no. 500 018</b></p> <p>Material: Steel, zinc plated</p>	 <p><b>Hex jam nut 3/4"-16 UNF-3A</b>  <b>Part no. 500 015</b></p> <p>Material: Steel, zinc plated</p>	 <p><b>Fixing clip</b>  <b>Part no. 561 481</b></p> <p>Application: Used to secure sensor rods (Ø 10 mm (Ø 0.39 in.)) when using an U-magnet or block magnet          Material: Brass, non-magnetic</p>

4.7 Frequently ordered accessories for ET-P – Additional options available in our [Accessories Guide](#) 551 444

Position magnets

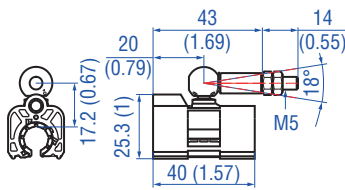

**Magnet slider S, joint at top**  
Part no. 252 182

Material: GRP, magnet hard ferrite  
Weight: Approx. 35 g  
Operating temperature:  
-40...+85 °C (-40...+185 °F)

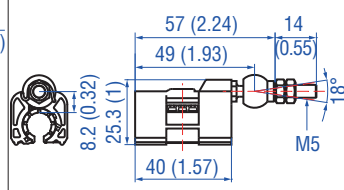

**Magnet slider V, joint at front**  
Part no. 252 184

Material: GRP, magnet hard ferrite  
Weight: Approx. 35 g  
Operating temperature:  
-40...+85 °C (-40...+185 °F)

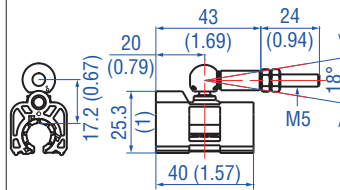

**Magnet slider N  
longer ball-joint arm**  
Part no. 252 183

Material: GRP, magnet hard ferrite  
Weight: Approx. 35 g  
Operating temperature:  
-40...+85 °C (-40...+185 °F)

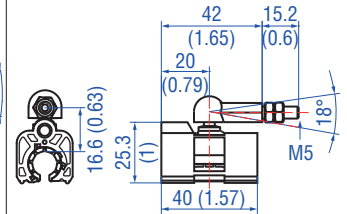

**Magnet slider G, backlash free**  
Part no. 253 421

Material: GRP, magnet hard ferrite  
Weight: Approx. 25 g  
Operating temperature:  
-40...+85 °C (-40...+185 °F)

Position magnets

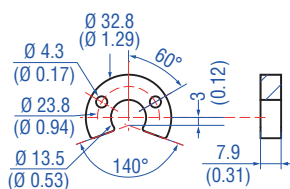

**U-magnet OD33**  
Part no. 251 416-2

Material: PA ferrite GF20  
Weight: Approx. 11 g  
Surface pressure: Max. 40 N/mm<sup>2</sup>  
Fastening torque for M4 screws: 1 Nm  
Operating temperature:  
-40...+105 °C (-40...+221 °F)

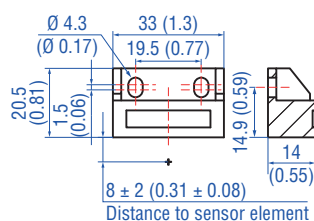

**Block magnet L**  
Part no. 403 448

Material: Plastic carrier with hard ferrite magnet  
Weight: Approx. 20 g  
Fastening torque for M4 screws: 1 Nm  
Operating temperature:  
-40...+75 °C (-40...+167 °F)

This magnet may influence the sensor performance specifications for some applications.

Mounting accessories

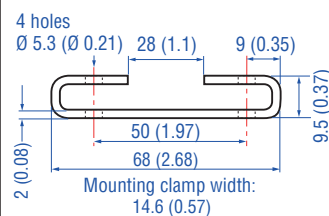

**Mounting clamp**  
Part no. 400 802

Material: Stainless steel (AISI 304)

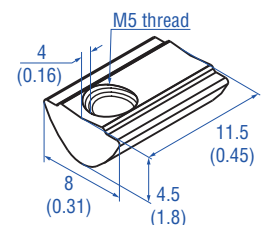

**T-nut**  
Part no. 401 602

Fastening torque for M5 screw: 4.5 Nm



**4.8 Frequently ordered accessories** – Additional options available in our [Accessories Guide](#) 551 444

**Cables**

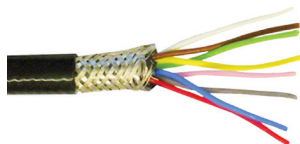

**Teflon® cable**  
**Part no. 530 112**

Name of cable in order code: **T**

Material: Teflon® jacket; black  
 Features: Twisted pair, shielded, flexible, high thermal resistance, mostly oil & acid resistant  
 Cable Ø: 7.6 mm (0.3 in.)  
 Cross section:  $4 \times 2 \times 0.25 \text{ mm}^2$   
 Bending radius:  $8 - 10 \times D$  (fixed installation)  
 Operating temperature:  $-100 \dots +180 \text{ °C}$  ( $-148 \dots +356 \text{ °F}$ )

**Silicone cable**  
**Part no. 530 113**

Name of cable in order code: **V**

Material: Silicone jacket; red  
 Features: Twisted pair, shielded, highly flexible, halogen free, high thermal resistance  
 Cable Ø: 7.2 mm (0.28 in.)  
 Cross section:  $3 \times 2 \times 0.25 \text{ mm}^2$   
 Bending radius:  $5 \times D$  (fixed installation)  
 Operating temperature:  $-50 \dots +180 \text{ °C}$  ( $-58 \dots +356 \text{ °F}$ )

**Programming tool** (Not approved for use in hazardous environments)



**Programming kit**  
**Part no. 254 590**

Kit includes:

- 1 × interface converter box,
- 1 × power supply
- 1 × cable (60 cm) with M12 female connector (8 pin), straight – D-sub female connector (9 pin), straight
- 1 × cable (60 cm) with M16 female connector (7 pin), straight – D-sub female connector (9 pin), straight
- 1 × cable (60 cm) with 6 × terminal clamp – D-sub female connector (9 pin), straight
- 1 × USB cable

Software is available at:  
[www.mtssensors.com](http://www.mtssensors.com)

## 5. Operation

### 5.1 Getting started

The sensor is factory-set to its order sizes and adjusted, i.e. the distance between magnet and flange is specified in resolution steps.

**Example:** SSI value 5000 with a resolution of 20 µm corresponds to a magnet distance of 100 mm from the flange

**NOTICE** If necessary, the SSI sensors can be re-adjusted using the service tool described below.

#### NOTICE

##### Observe during commissioning

1. Before switching on for the first time, check the connection of the sensor carefully.
2. Position the magnet in the measuring range of the sensor during first commissioning and after replacement of the magnet.
3. Ensure that the sensor control system cannot be displaced in an uncontrolled way when switching on.
4. Ensure that the sensor is ready and in operation mode after switching on.
5. Check the pre-set span start and end values of the measuring range (Fig. 22) and correct them via the customer's control system if necessary, or via the MTS Sensors service tool. The operation of the service tool is described in detail on the following pages.

### 5.2 Programming and configuration

#### SSI interface

The interface of Temposonics® position sensors corresponds to SSI industry standard for absolute encoders. Its displacement value is encoded in a 24 / 25 bit binary or gray format and transmitted as a differential signal in SSI standard (RS 422).

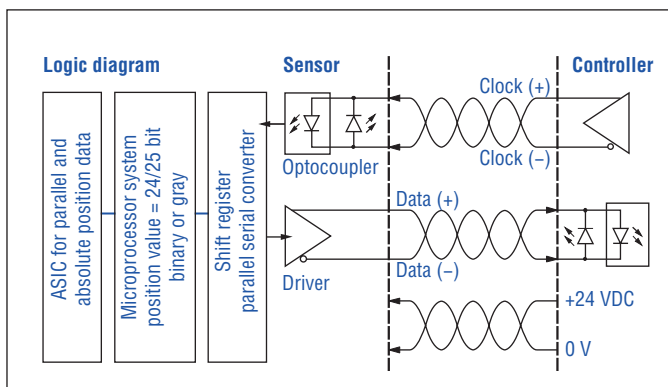

Fig. 22: Schematic connection

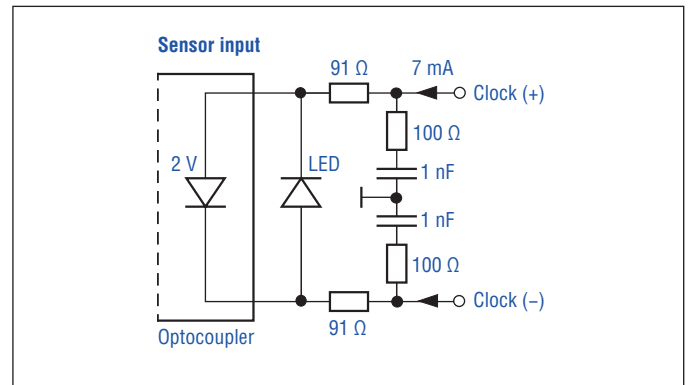

Fig. 23: Input wiring clock (+) / clock (-)

The absolute, parallel position data is continually updated by the sensor and converted by the shift-register into a serial bit stream (Fig. 24).

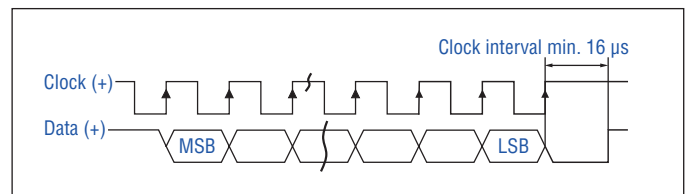

Fig. 24: Timing diagram

Dependent on the baud rate chosen in the controller the following cable lengths are possible (Fig. 25):

Cable length	< 3 m	< 50 m	< 100 m	< 200 m	< 400 m
Baud rate	1 MBd	< 400 kBd	< 300 kBd	< 200 kBd	< 100 kBd

Fig. 25: Cable lengths and related baud rates

### MTS Sensors programming tools

Temposonics® position sensors can be adapted to modified measurement tasks very easily via the connecting leads – without opening the sensor. For this, the following MTS Sensors programming tool is available (see page 14).

**NOTICE** The programming tool is not approved for use in hazardous environments.

#### Programming kit, part no. 254 590

The PC programmer is a hardware converter between sensor and serial PC interface. It can be used for adjusting sensor parameters via computer and the MTS Sensors programming software. The software for reading and adjusting the sensors requires a Windows computer with a free USB port. You can adjust the following parameters:

- Data length and data format
- Resolution and measuring direction
- Synchronous / asynchronous measurement
- Measurement filter (moving average of 2, 4 or 8 measurements)

#### Step 1: Connect PC programmer

Step 2: Install software

Step 3: Start program

- Connect the PC programmer with the sensor via the corresponding adapter cable.
- Connect the PC programmer to a USB port of the computer.
- Connect the power supply via connector.  
The outer contact of the connector is 0 V (ground), the inner contact is 24 VDC.

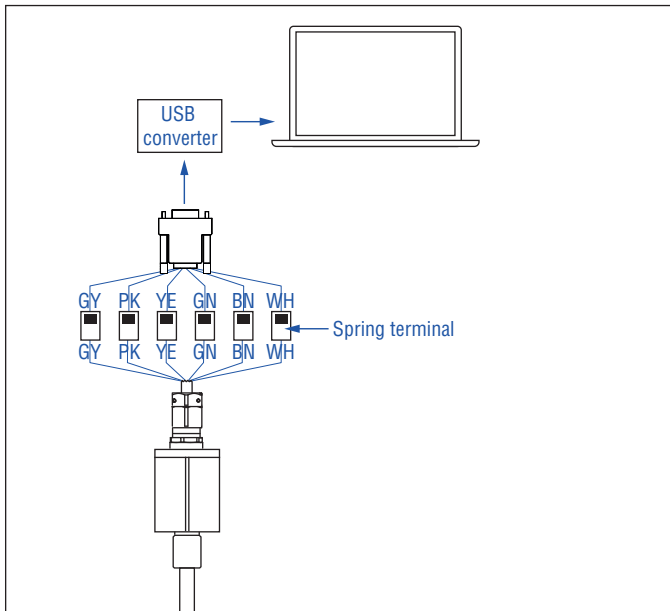

Fig. 26: Connect PC programmer

### NOTICE

Never connect / disconnect the sensor when voltage is applied.

Step 1: Connect PC programmer

Step 2: Install software

Step 3: Start program

Download the current software version from [www.mtssensors.com](http://www.mtssensors.com). Install the software .NET Framework as administrator. Copy the program MTS\_SSI\_Serial\_Configurator.exe to your computer and start it.

System requirements:

- Microsoft Windows 7 operating system or higher
- Microsoft .NET Framework from version 4.5.1 or higher

Step 1: Connect PC programmer

Step 2: Install software

Step 3: Start program

After starting the program MTS ET SSI Serial Configurator the software connects to the last selected COM Port and the user interface opens (Fig. 29). If the COM Port is not available an error message appears (Fig. 27).

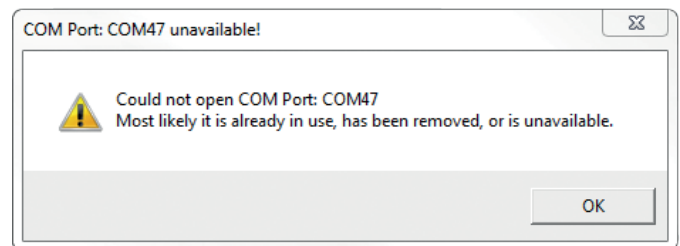

Fig. 27: Error message COM Port is not available

Select the right COM Port from the list (example see Fig. 28).

The application will automatically restart and the user interface opens (Fig. 29).

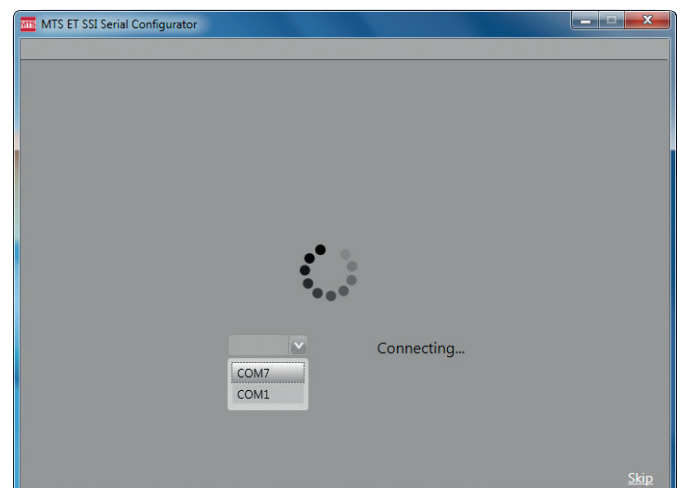

Fig. 28: Select COM Port

## MTS ET SSI software user interface

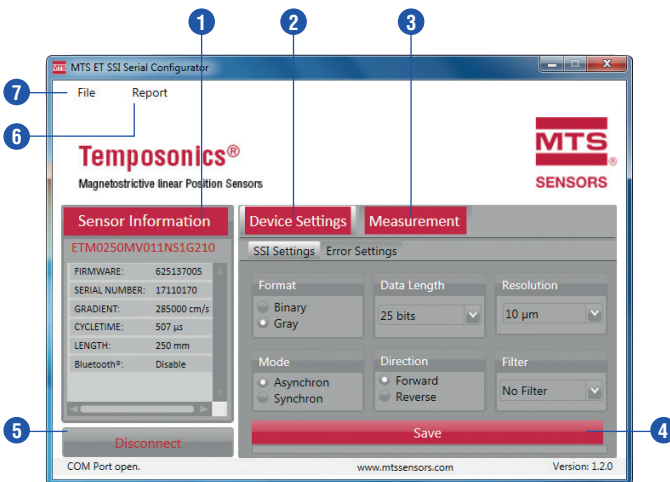

Fig. 29: MTS ET SSI Serial Configurator, SSI Settings

- 1 **Sensor Information** contains the invariable sensor parameters, which were read in automatically when the sensor is connected (Fig. 29).
- 2 In the **Device Settings** menu the configurable parameters (SSI Settings, Error Settings) of the sensor can be set (Fig. 29).
- 3 The **Measurement** menu shows the current position of the magnet (Fig. 29).
- 4 The **Save** button saves any parameter changes you have made. After that the software restarts for the changes to take effect. The function **Measurement** 3 will then be available again (Fig. 29).
- 5 The button **Disconnect** breaks the connection to the COM Port and closes the software (Fig. 29).
- 6 By clicking **Report** a report document is generated to provide sensor information (Fig. 29).
- 7 The **File** menu allows the following settings (Fig. 29):
  1. **Open**: Uploads device settings from a XML file to the sensor. Click the **Save** button 4 to complete the upload
  2. **Save as**: Saves the current device settings as XML file
  3. **Restore Factory Settings**: Restores and saves the sensor's factory settings
  4. **Close**: Closes the software application without saving any parameters

## Device Settings

The following parameters can be modified:

### SSI Settings (Fig. 29)

Format: **Binary/Gray**  
 Data Length: **24 bits/25 bits**  
 Resolution: **5 µm/10 µm/20 µm/50 µm/100 µm**  
 Mode: **Asynchron:**

In asynchronous mode the sensor starts measuring and provides the position independent of the PLC.

### Synchron:

In synchronous mode the output of the Temposonics® SSI sensor is matched to the data request cycle of the controller.

Direction:

### Forward:

Ascending position values from sensor electronics housing to rod end

### Reverse:

Ascending position values from rod end to sensor electronics housing

Filter:

### No Filter / Filter Grad 2 / Filter Grad 4 / Filter Grad 8:

Moving average of 2, 4 or 8 measurements for noise reduction

### Error Settings (Fig. 30)

Error Counter: 1  
 Error Value: 0

The **Error Counter** and **Error Value** settings determine, how often an error has to occur (**Error Counter**) so that a certain **Error Value** is shown. The standard settings for the **Error Counter** is "1" and for the **Error Value** it is "0". So every error is shown with an error value of "0". Both parameters are changeable.

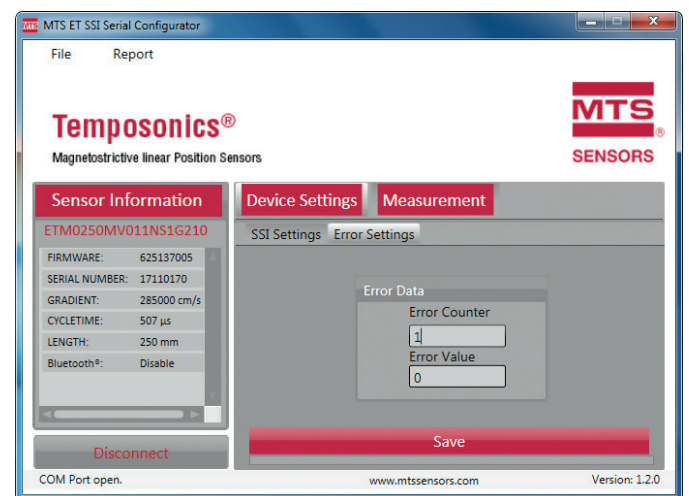

Fig. 30: Error Settings

### Measurement

After clicking the **Start Read** button the current position of the magnet is shown. Click the **Stop Read** button to stop the measurement (Fig. 31). The **View** button provides a graphic display of the magnet's position (Fig. 32).

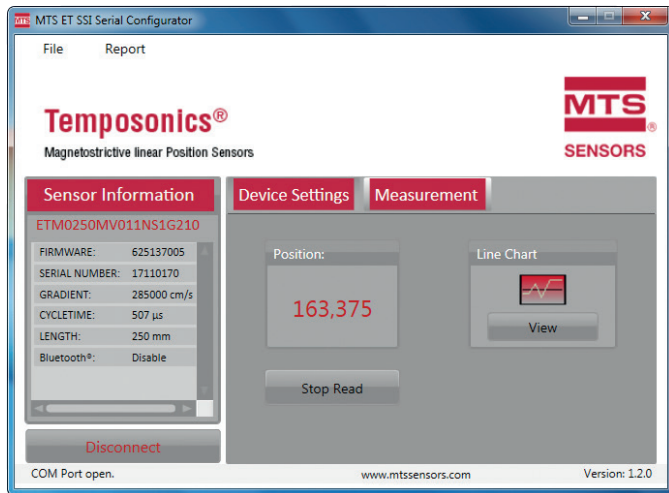

Fig. 31: Display of current magnet position

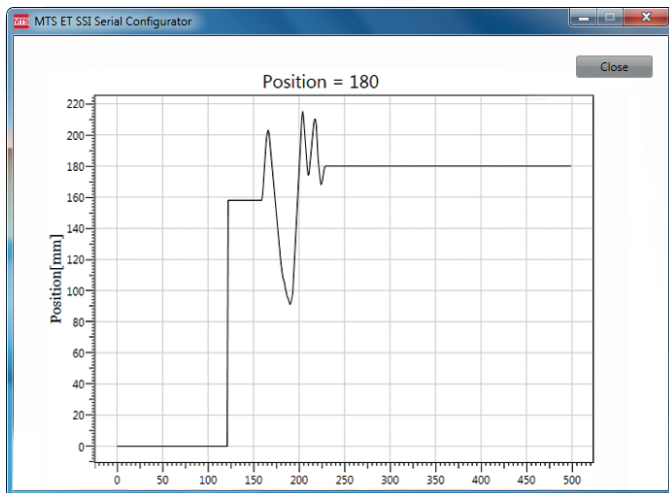

Fig. 32: Data display

## 6. Maintenance and troubleshooting

### 6.1 Error conditions, troubleshooting

Error condition	Status
Magnet not detected	<b>Default error value: 0</b> <b>Adapted error value:</b> 0...16777215 (see Fig. 30)
Wrong quantity of magnets	<b>Default error value: 0</b> <b>Adapted error value:</b> 0...16777215 (see Fig. 30)

### 6.2 Maintenance

The required inspections need to be performed by qualified personnel according to IEC 60079-17 / TRBS 1203. These inspections should include at least a visual inspection of the housing, associated electrical equipment entrance points, retention hardware and equipment grounding. Inside the Ex-atmosphere the equipment has to be cleaned regularly. The user determines the intervals for checking according to the environmental conditions present at the place of operation. After maintenance and repair all protective devices removed for this purpose must be refitted.

In case of equipment faults, remove the equipment. The inner parts cannot be maintained by the customer. In this case send the equipment to the manufacturer for inspection.

#### NOTICE

It is not allowed to open the sensor.

Type of inspection	Visual inspection every 3 months	Close inspection every 6 months
Visual inspection of the sensor for intactness, removal of dust deposits	●	
Check of entire system	User's responsibility	

Fig. 33: Schedule of inspection

**Maintenance:** Defines a combination of any actions carried out to retain an item in, or restore it to, conditions in which it is able to meet the requirements of the relevant specification and perform its required functions.

**Inspection:** Defines an activity with the purpose to check a product carefully, aiming at a reliable statement on the condition of the product. The inspection is carried out without dismantling, or, if necessary, with partial dismantling, and supplemented by other measures, e.g. measurements.

**Visual inspection:** Optical inspection of product aims at the recognition of visible defects like missing bolts without using auxiliary equipment and tools.

**Close inspection:** Defines an inspection which encompasses those aspects covered by a visual inspection and, in addition, identifies those defects, such as loose bolts, which will be apparent only by the use of access equipment, for example steps, where necessary, and tools.

### 6.3 Repair

Repairs on the sensor may be performed only by MTS Sensors or an explicitly authorized body.

### 6.4 List of spare parts

No spare parts are available for this sensor.

### 6.5 Transport and storage

The conditions of transport and storage of the sensor match the operating conditions mentioned in this document.

## 7. Removal from service / dismantling

The product contains electronic components and must be disposed of in accordance with the local regulations.

## 8. Technical data of Temposonics® ET

Output	
Interface	SSI (Synchronous Serial Interface) – Differential signal in SSI standard
Data format	Binary, gray
Data length	24 bit/25 bit
Measured value	Position
Measurement parameters	
Resolution	5 µm/10 µm/20 µm/50 µm/100 µm
Cycle time	Up to 3.7 kHz, depending on stroke length
Linearity <sup>5</sup>	≤ ±0.02 % F.S. (minimum ±60 µm)
Repeatability	≤ ±0.005 % F.S. (minimum ±20 µm) typical
Operating conditions	
Operating temperature	–40...+90 °C (–40...+194 °F)
Humidity	90 % relative humidity, no condensation
Ingress protection	With Teflon® cable (part no. 530 112): IP66 With silicone cable (part no. 530 113): IP68 (2 bar (29 psi) @ 30 min)
Shock test	100 g (single shock), IEC standard 60068-2-27
Vibration test	20 g/10...2000 Hz, IEC standard 60068-2-6 (excluding resonant frequencies)
EMC test	Electromagnetic emission according to EN 61000-6-4 Electromagnetic immunity according to EN 61000-6-2 The sensor meets the requirements of the EU directives and is marked with <b>CE</b>
Operating pressure	Up to 350 bar (5,076 psi)
Magnet movement velocity <sup>6</sup>	Any
Design/Material	
Sensor electronics housing/ Flange	Stainless steel 1.4305 (AISI 303); option: Stainless steel 1.4404 (AISI 316L)
Sensor rod	Stainless steel 1.4306 (AISI 304L); option: Stainless steel 1.4404 (AISI 316L)
Stroke length	50...3000 mm (1...118 in.)
Mechanical mounting	
Mounting position	Any
Mounting instruction	Please consult the technical drawings on page 8
Electrical connection	
Connection type	Cable outlet
Operating voltage	+24 VDC (–15/+20 %)
Ripple	≤ 0.28 V <sub>pp</sub>
Current consumption	90 mA typical, dependent on stroke length
Dielectric strength	700 VDC (DC ground to machine ground)
Polarity protection	Up to –30 VDC
Overvoltage protection	Up to 36 VDC

4/ With position magnet # 251 416-2

5/ If there is contact between the moving magnet including the magnet holder and the sensor rod, make sure that the maximal speed of the moving magnet is ≤ 1 m/s (ATEX requirement due to ESD [Electro Static Discharge])



Certification
⊕ II 3G Ex nC IIC T4 Gc/Ex tD A21 IP66/IP68 T130°C
⊕ II 3D Ex tc IIIC T130 °C Dc IP66/IP68
Class I/II/III Div 2 T4 ABCDFG
Class I Zone 2 T4 IIC
Zone 22 AEx tc T4 IIIC Dc
-40 °C ≤ Ta ≤ 90 °C, Type: 4X

Fig. 34: Certification of Temposonics® ET (version A and E)

## 9. Appendix

### Safety declaration

Dear Customer,

If you return one or several sensors for checking or repair, we need you to sign a safety declaration. The purpose of this declaration is to ensure that the returned items do not contain residues of harmful substances and/or that people handling these items will not be in danger.

MTS Sensors order number: \_\_\_\_\_ Sensor type(s): \_\_\_\_\_

Serial number(s): \_\_\_\_\_ Sensor length(s): \_\_\_\_\_

**The sensor has been in contact with the following materials:**

Do not specify chemical formulas.  
Please include safety data sheets of the substances, if applicable.

In the event of suspected penetration of substances into the sensor, consult MTS Sensors to determine measures to be taken before shipment.

**Short description of malfunction:**

**Corporate information**

Company: \_\_\_\_\_

Address: \_\_\_\_\_

\_\_\_\_\_

**Contact partner**

Name: \_\_\_\_\_

Phone: \_\_\_\_\_

E-mail: \_\_\_\_\_

We hereby certify that the measuring equipment has been cleaned and neutralized.  
Equipment handling is safe. Personnel exposure to health risks during transport and repair is excluded.

Stamp \_\_\_\_\_ Signature \_\_\_\_\_ Date \_\_\_\_\_

**GERMANY**  
**MTS Sensor Technologie**  
**GmbH & Co.KG**  
 Auf dem Schüffel 9  
 58513 Lüdenscheid, Germany  
 Tel. +49-23 51-95 87 0  
 Fax. +49-23 51-5 64 91  
 info.de@mtssensors.com  
 www.mtssensors.com

**USA**  
**MTS Systems Corporation**  
**Sensors Division**  
 3001 Sheldon Drive  
 Cary, N.C. 27513, USA  
 Tel. +1 919 677-0100  
 Fax +1 919 677-0200  
 info.us@mtssensors.com  
 www.mtssensors.com

## 10. Declaration of conformity

### EU-Declaration of Conformity EU-Konformitätserklärung Déclaration UE de Conformité

MTS Sensor Technologie GmbH & Co. KG



**SENSORS**  
www.mtssensors.com

declares as manufacturer in sole responsibility that the position sensor type  
erklärt als Hersteller in alleiniger Verantwortung, dass der Positionssensor Typ  
déclare en qualité de fabricant sous sa seule responsabilité que les capteurs position de type

EC15.012D

**Temposonics® ET-x-xxxxx-xxx-1-A-Sxxxxxx ET-x-xxxxx-xxx-1-E-Sxxxxxx**

comply with the regulations of the following European Directives:  
den Vorschriften folgender Europäischen Richtlinien entsprechen:  
sont conformes aux prescriptions des directives européennes suivantes:

- 2014/30/EU** Electromagnetic Compatibility  
Elektromagnetische Verträglichkeit  
Compatibilité électromagnétique
- 2014/34/EU** Equipment and protective systems for use in potentially explosive atmospheres  
Geräte und Schutzsysteme zur Verwendung in explosionsgefährdeten Bereichen  
Appareils et systèmes de protection à être utilisés en atmosphères explosibles
- 2011/65/EU** Restriction of the use of hazardous substances in electrical and electronic equipment  
Beschränkung der Verwendung gefährlicher Stoffe in Elektro- und Elektronikgeräten  
Limitation de l'utilisation de substances dangereuses dans les équipements électriques et électroniques

Applied harmonized standards / Angewandte harmonisierte Normen / Normes harmonisées appliquées:

**EN 60079-0 :2012 + A11 :2013, EN 60079-15 :2010, EN 60079-31 :2014  
EN 61000-6-2 :2005, EN 61000-6-4:2007+A1 :2011, EN 50581 :2012**

The technical content of these standards has been checked against the most recent editions. They continue to satisfy the EHSR's of the Directive.

Der technische Inhalt dieser Normen wurde anhand der neuesten Ausgaben überprüft. Sie entsprechen weiterhin den Grundlegenden Sicherheits- und Gesundheitsanforderungen der Richtlinie.

Le contenu technique de ces normes a été vérifié par rapport aux éditions les plus récentes. Elles continuent de satisfaire aux exigences de la directive concernant le règlement sur la santé et la sécurité au travail.

EC type examination certificate: **CML 16 ATEX 4352X Issue 1**  
EG-Baumusterprüfbescheinigung:  
Certificat de l'examen CE:

Issued by / ausgestellt durch / exposé par: **Certification Management Limited (2503)  
Ellesmere Port CH65 4LZ, United Kingdom**

Notified body for quality assurance control: **Certification Management B.V.  
Benannte Stelle für Qualitätsüberwachung: Hoogoorddreef 15, 1101BA, Amsterdam, The Netherlands  
Organisme notifié pour l'assurance qualité:**

Ident number / Kennnummer / **2776**  
No. d'identification:

Kennzeichnung / Marking / Marquage: **II 3G Ex nC IIC T4 Gc  
II 3D Ex tc IIIC T130°C Dc IP66/IP68  
-40°C ≤ Tamb ≤ +90°C**

Luedenscheid, 2020-12-07

Dr.-Ing. Eugen Davidoff  
Zulassungsmanager / Approvals Manager



MTS Sensor Technologie GmbH & Co. KG, Auf dem Schüffel 9, D-58513 Luedenscheid · Tel. +49-2351-9587-0 · Fax +49-2351-56491 · info.de@mtssensors.com Amtsgericht Iserlohn HRA 3314 · Persönlich haftende Gesellschafterin: MTS Sensor Technologie und Verwaltungs GmbH, Amtsgericht Iserlohn HRB 4044 Geschäftsführer: Dr.-Ing. Thomas Grahl, David Thomas Hore · USt-IdNr.: DE 125 802 421 · Bankverbindung: HSBC Trinkaus & Burkhardt AG, Düsseldorf Swift-BIC: TUBDEDD · IBAN: DE96 3003 0880 0013 6170 07





**QPS Evaluation Services Inc**  
Testing, Certification and Field Evaluation Body  
Accredited in Canada, the USA, and Internationally

File  
LR1346

**CERTIFICATE OF COMPLIANCE**  
(ISO TYPE 3 CERTIFICATION SYSTEM)

Issued to	MTS Sensor Technologie GmbH & Co KG
Address	Auf Dem Schüffel 9, Lüdenscheid, Germany, D-58513
Project Number	LR1346-3
Product	Linear Position Sensors
Model Number	Tempsonics ® E-Series ET (see annex below for full model information)
Ratings/Markings	see annex below for full marking information
Applicable Standards	CSA C22.2 No. 60079-0:2015, CSA C22.2 No. 60079-15:2016, CSA C22.2 No 60079-31:2015, CSA C22.2 No 61010-1:2012, CSA C22.2 94.2:2015 ANSI/ISA 12.12.01 (2015), ANSI/UL 61010-1 (2012), ANSI/UL 50E 2nd Edition, ANSI/UL 60079-0 (2013), ANSI/UL 60079-31 (2015), ANSI/UL 2225 (2013)
Factory/Manufacturing Location	Same as above

**Statement of Compliance:** The product(s) identified in this Certificate and described in the Report covered under the above referenced project number have been investigated and found to be in compliance with the relevant requirements of the above referenced standard(s). As such, they are eligible to bear the QPS Certification Mark shown below, in accordance with the provisions of QPS's Service Agreement.



Issued By: Dave Adams P.Eng.

Signature: 

Date: March 28, 2017



**QPS Evaluation Services Inc**  
Testing, Certification and Field Evaluation Body  
Accredited in Canada, the USA, and Internationally

<b>File</b>
LR1346

**Annex:**

Product: Linear Position Sensors Tempsonics® E-Series ET  
Models: SSI Output, Analog & Digital Start/Stop

<b>Model (output)</b>	<b>Canada</b>	<b>US</b>
Analog	Ex nC IIC T4 Gc Ex tc IIIC T130°C Dc IP66/68 -40°C ≤Ta≤85°C Type 4X	Class I/II/III Div 2 T4 ABCDFG Class I Zone 2 T4 IIC Zone 22 AEx tc T4 IIIC Dc -40°C ≤Ta≤85°C, Type 4X
Digital Start/Stop	Ex nC IIC T4 Gc Ex tc IIIC T130°C Dc IP66/68 -40°C ≤Ta≤105°C Type 4X	Class I/II/III Div 2 T4 ABCDFG Class I Zone 2 T4 IIC Zone 22 AEx tc T4 IIIC Dc -40°C ≤Ta≤105°C, Type 4X
SSI Output	Ex nC IIC T4 Gc Ex tc IIIC T130°C Dc IP66/68 -40°C ≤Ta≤90°C Type 4X	Class I/II/III Div 2 T4 ABCDFG Class I Zone 2 T4 IIC Zone 22 AEx tc T4 IIIC Dc -40°C ≤Ta≤90°C, Type 4X

\*Models are differentiated by output signal type

Each model has its own designated ambient range and dust temperature limitation (see table).

The sensors are supplied with a permanently connected cable with a rated voltage of 24 (-15%, +20%) VDC and a maximum current of 105 mA.

The equipment is intended for permanent field installation.

Model nomenclature below:



# IECEX Certificate of Conformity

## INTERNATIONAL ELECTROTECHNICAL COMMISSION IEC Certification Scheme for Explosive Atmospheres

for rules and details of the IECEx Scheme visit [www.iecex.com](http://www.iecex.com)

Certificate No.: IECEx CML 16.0125X Issue No: 1 Certificate history:  
Status: **Current** Page 1 of 4 [Issue No. 1 \(2017-03-09\)](#)  
Date of Issue: **2017-03-09** [Issue No. 0 \(2017-02-23\)](#)

Applicant: **MTS Sensor Technologie GmbH**  
Auf Dem Schüffel 9  
Ludenscheid  
D-58513  
**Germany**

Equipment: **Linear Position Sensor Temposonics E-Series ET**  
*Optional accessory:*

Type of Protection: **Sealed Device "nC", Protection by enclosure "tc"**

Marking:  
Ex nC IIC T4 Gc  
Ex tc III C T130°C Dc  
Refer to Annex for further marking detail.

Approved for issue on behalf of the IECEx  
Certification Body:

A Snowdon

Position:

Certification Officer

Signature:  
(for printed version)

Date:

March 9, 2017

1. This certificate and schedule may only be reproduced in full.
2. This certificate is not transferable and remains the property of the issuing body.
3. The Status and authenticity of this certificate may be verified by visiting the [Official IECEx Website](#).

Certificate issued by:

**Certification Management Limited**  
Unit 1, Newport Business Park  
New Port Road  
Ellesmere Port, CH65 4LZ  
United Kingdom







Sensor with Ex approval

**UNITED STATES** 3001 Sheldon Drive  
**MTS Systems Corporation** Cary, N.C. 27513  
**Sensors Division** Phone: +1 919 677-0100  
Americas & APAC Region E-mail: info.us@mtssensors.com

**GERMANY** Auf dem Schüffel 9  
**MTS Sensor Technologie** 58513 Lüdenscheid  
**GmbH & Co. KG** Phone: +49 2351 9587-0  
EMEA Region & India E-mail: info.de@mtssensors.com

**ITALY** Phone: +39 030 988 3819  
Branch Office E-mail: info.it@mtssensors.com

**FRANCE** Phone: +33 1 58 4390-28  
Branch Office E-mail: info.fr@mtssensors.com

**UK** Phone: +44 79 44 15 03 00  
Branch Office E-mail: info.uk@mtssensors.com

**SCANDINAVIA** Phone: +46 70 29 91 281  
Branch Office E-mail: info.sca@mtssensors.com

**CHINA** Phone: +86 21 2415 1000 / 2415 1001  
Branch Office E-mail: info.cn@mtssensors.com

**JAPAN** Phone: +81 3 6416 1063  
Branch Office E-mail: info.jp@mtssensors.com

**Document Part Number:**  
551889 Revision C (EN) 02/2021



[www.mtssensors.com](http://www.mtssensors.com)