

Brief Instruction

R-Series

Magnetostrictive Linear Position Sensors



Temposonics® R-Series

Brief Instructions

Table of contents

1. Introduction	3
2. Safety instructions	4
2.1 Intended use	4
2.2 Forseeable misuse	4
2.3 Installation, commissioning and operation	5
2.4 Safety instructions for use in explosion-hazardous areas	5
2.5 Warranty	5
2.6 Return	5
2.7 Maintenance & removal	5
3. Identification	6
3.1 Temposonics® RP	6
3.2 Temposonics® RH	6
3.3 Temposonics® RD4	7
3.4 Temposonics® RT4	7
3.5 Temposonics® RF	7
4. Installation & mounting	8
4.1 Magnet installation	8
4.2 Mounting dimensions of R-Series	9
4.3 Multi-position measurement distances	11
5. Electrical connections	12
5.1 Analog	13
5.2 SSI	13
5.3 Profibus	14
5.4 CANbus	15
5.5 DeviceNet	16
5.6 EtherCAT®	16
5.7 EtherNet/IP™	17
5.8 Powerlink	18
5.9 Profinet	18

1. Introduction

1.1 Purpose and use of this manual

Before starting the operation of Temposonics® position sensors, read this documentation thoroughly and follow the safety information. Keep this manual for future reference!

The content of this technical documentation is intended to provide information on mounting, installation and commissioning by qualified automation personnel¹ or instructed service technicians who are familiar with the project planning and dealing with Temposonics® position sensors.

1.2 Used symbols and warnings

Warnings are intended for your personal safety and for avoidance of damage to the described product or connected devices. In this documentation, safety information and warnings to avoid danger that might affect the life and health of operating or service personnel or cause material damage are highlighted by the pictogram defined below.

Symbol	Meaning
NOTICE	This symbol is used to point to situations that may lead to material damage, but not to personal injury.

- 1/ The term “qualified technical personnel” characterizes persons who:
- are familiar with the safety concepts of automation technology applicable to the particular project,
 - are competent in the field of electromagnetic compatibility (EMC),
 - have received adequate training for commissioning and service operations
 - are familiar with the operation of the device and know the information required for correct operation provided in the product documentation.

Temposonics® R-Series

Brief Instructions

2. Safety instructions

2.1 Intended use

This product may be used only for the applications defined under item 1 and only in conjunction with the third-party devices and components recommended or approved by Temposonics. As a prerequisite of proper and safe operation, the product requires correct transport, storage, mounting and commissioning and must be operated with utmost care.

1. The sensor systems of all Temposonics® series are intended exclusively for measurement tasks encountered in industrial, commercial and laboratory applications. The sensors are considered as system accessories and must be connected to suitable evaluation electronics, e.g. a PLC, IPC, indicator or other electronic control unit.

2.2 Foreseeable misuse

Foreseeable misuse	Consequence
Lead compensating currents through the enclosure	The sensor will be damaged
Wrong sensor connection	The sensor does not work properly or can be destroyed
Operate the sensor out of the operating temperature range	No signal output The sensor can be damaged
Power supply is out of the defined range	Signal output is wrong / no signal output / the sensor can be damaged
Position measurement is influenced by an external magnetic field	Signal output is wrong
Cables are damaged	Short circuit – The sensor can be destroyed / sensor does not respond
Spacers are missing / are installed in the wrong order	Error in position measurement
Wrong connection of ground / shield	Signal output is disturbed The electronics can be damaged
Use of a magnet that is not certified by Temposonics	Error in position measurement
Output 2 is connected to ground with low-impedance, output 1 is connected with high-impedance	The sensor is in programming mode – The sensor delivers faulty position values

Do not reprocess the sensor.
→ The sensor might be damaged.

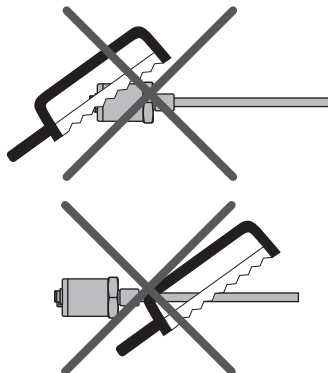

Do not step on the sensor.
→ The sensor might be damaged.

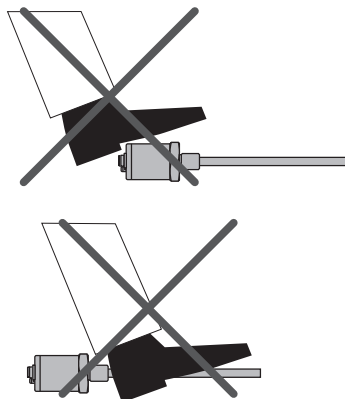

Manuals, Software & 3D models
available at: www.temposonics.com

2.3 Installation, commissioning and operation

The position sensors must be used only in technically safe condition. To maintain this condition and to ensure safe operation, installation, connection and service, work may be performed only by qualified technical personnel.

If danger of injury to persons or of damage to operating equipment is caused by sensor failure or malfunction, additional safety measures such as plausibility checks, limit switches, EMERGENCY STOP systems, protective devices etc. are required. In the event of trouble, shut down the sensor and protect it against accidental operation.

Safety instructions for commissioning

To maintain the sensor operability, it is mandatory to follow the instructions given below.

1. Protect the sensor against mechanical damage during installation and operation.
2. Do not open or dismantle the sensor.
3. Connect the sensor very carefully and pay attention to the polarity of connections and power supply.
4. Use only approved power supplies.
5. It is indispensable to ensure that the specified permissible limit values of the sensor for operating voltage, environmental conditions, etc. are met.
6. Check the function of the sensor regularly and provide documentation of the checks.
7. Before system switch-on, ensure that nobody's safety is jeopardized by starting machines.

2.4 Safety instructions for use in explosion-hazardous areas

The sensors are not suitable for operation in explosion-hazardous areas.

2.5 Warranty

Temposonics grants a warranty² period for the Temposonics® position sensors and supplied accessories relating to material defects and faults that occur despite correct use in accordance with the intended application. The Temposonics obligation is limited to repair or replacement of any defective part of the unit. No warranty can be taken for defects that are due to improper use or above average stress of the product, as well as for wear parts. Under no circumstances will Temposonics accept liability in the event of offense against the warranty rules, no matter if these have been assured or expected, even in case of fault or negligence of the company. Temposonics explicitly excludes any further warranties. Neither the company's representatives, agents, dealers nor employees are authorized to increase or change the scope of warranty.

2.6 Return

For diagnostic purposes, the sensor can be returned to Temposonics GmbH & Co. KG. Any shipment cost will be borne by the sender². For a corresponding form, see detailed operation manual (available at: www.temposonics.com).

2.7 Maintenance & removal

Further information about maintenance and removal is provided in the sensor specific operation manuals.

^{2/} See also applicable Temposonics sales and supply conditions, e.g. under www.temposonics.com



Temposonics® R-Series

Brief Instructions

3. Identification

Nameplate (e.g. RH SSI)

Order code	RHM0425MD701S1G2100
Code output dependent	0.01 mm / 25 Bit gray Grd.: 2797.14 m/s
Serial no.	FNr.: 1413 3950



Approvals and certificates

You will find approvals and certificates in the sensor specific operation manuals.

3.1 Temposonics® RP (profile housing)

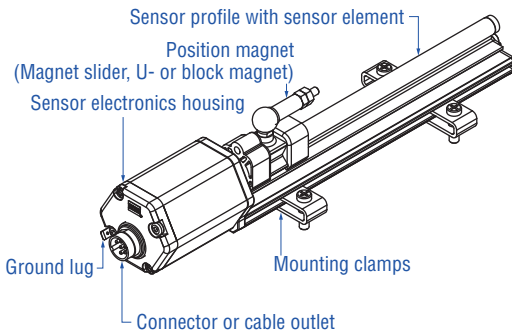

Available outputs:

- Analog
- SSI
- Profibus
- CANbus
- DeviceNet
- EtherCAT®
- EtherNet/IP™
- Powerlink
- Profinet

3.2 Temposonics® RH (rod housing)

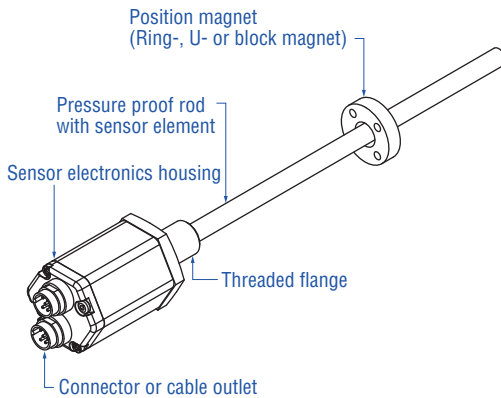

Available outputs:

- Analog
- SSI
- Profibus
- CANbus
- DeviceNet
- EtherCAT®
- EtherNet/IP™
- Powerlink
- Profinet

Manuals, Software & 3D models
available at: www.mtssensors.com

3.3 Temposonics® RD4 (sensor rod with detached electronics)

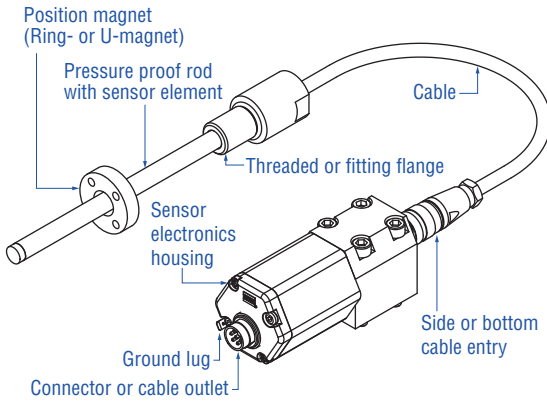

Available outputs:

- Analog
- SSI
- Profibus
- CANbus
- DeviceNet
- EtherCAT®
- EtherNet/IP™
- Powerlink
- Profinet

3.4 Temposonics® RT4 (sensor rod with redundant, detached electronics)

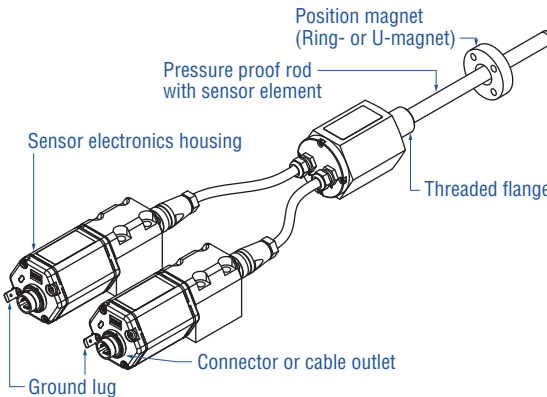

Available outputs:

- SSI

3.5 Temposonics® RF (flexible sensor rod)

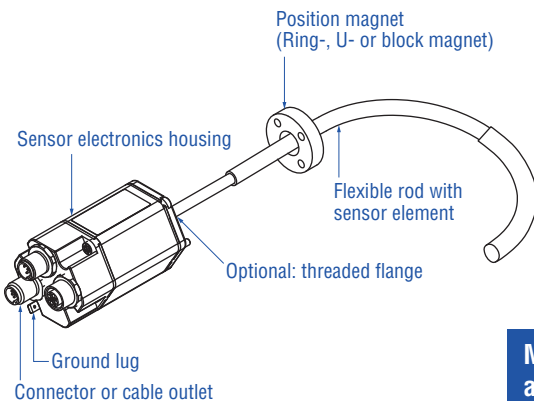





Available outputs:

- Analog
- SSI
- Profibus
- CANbus
- DeviceNet
- EtherCAT®
- EtherNet/IP™
- Powerlink
- Profinet

Manuals, Software & 3D models
available at: www.mtssensors.com

4. Installation & mounting

Typical use of magnets	
	For: RH, RD4, RT4 & RF • Rotationally symmetrical magnetic field
Ring magnet	
	For: RP, RH, RD4, RT4 & RF • The magnet can be lifted off RP • Height tolerances can be compensated
U-magnet	
	For: RP, RH & RF • The magnet can be lifted off • Height tolerances can be compensated
Block magnet	
	For: RP • The magnet is guided by the profile • The ideal distance is maintained between the magnet and the waveguide. • Easy coupling via the ball joint
Magnet slider	

4.1 Magnet installation

Install the magnet using non-magnetic material for mounting device, screws, spacers etc.. The magnet must not grind on the sensor rod. Alignment errors are compensated via the air gap.

- Max. permissible surface pressure: 40 N/mm²
- Max. fastening torque for M4 screws: 1 Nm; use washers, if necessary

NOTICE

Mount the ring magnet and U-magnet concentrically. Mount the block magnet centrally.

The maximum permissible air gap must not be exceeded.

Take care to mount the primary sensor axis in parallel to the magnet path in order to avoid damage to the carriage, magnet and sensor rod.

Concentric mounting of U-magnet

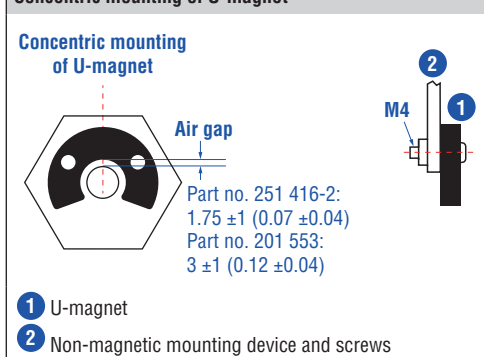

Centered mounting of block magnet

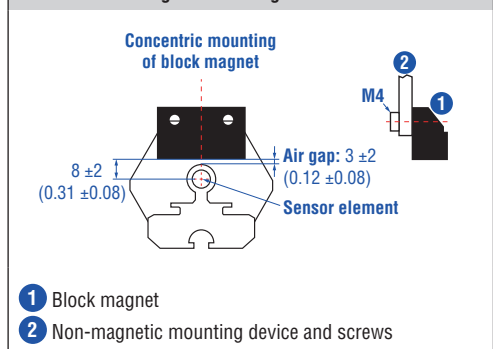

Magnet mounting with magnetic material

When using magnetic material the dimensions in the drawing beneath must be observed. If the position magnet is set further into the piston rod install another non-magnetic spacer above the magnet.

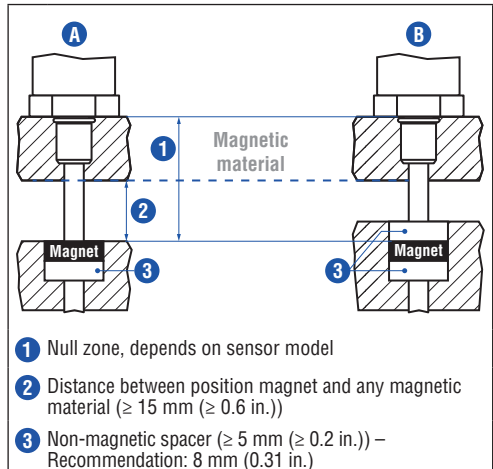

Sensors with stroke lengths ≥ 1 meter

Support horizontally installed sensors with a stroke length from 1 meter mechanically at the rod end. Without the use of a support, rod and position magnet may be damaged. A false measurement result is also possible. Longer rods require evenly distributed mechanical support over the entire length (e.g. part no. 561 481). Use an U-magnet for measurement.

Controlling design dimensions are in millimeters and measurements in () are in inches

4.2 Mounting dimensions of R-Series

RP with magnet slider "S" / "N" / "V" / "G"

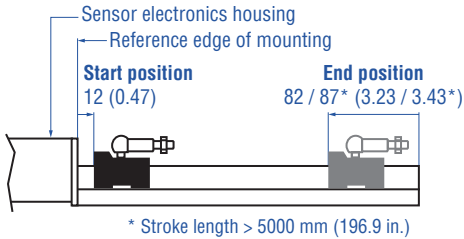

RH with block magnet

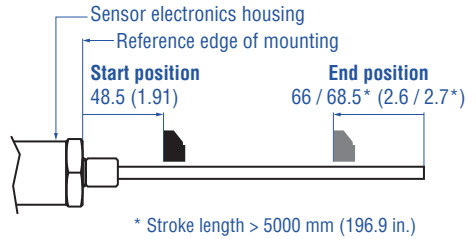

RP with U-magnet

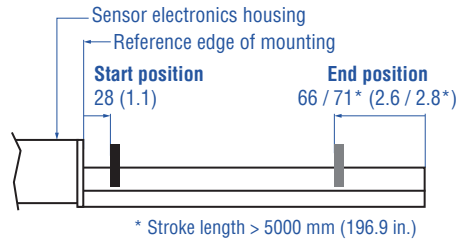

RD4-S with ring magnet / U-magnet

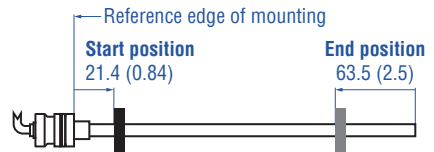

RP with block magnet

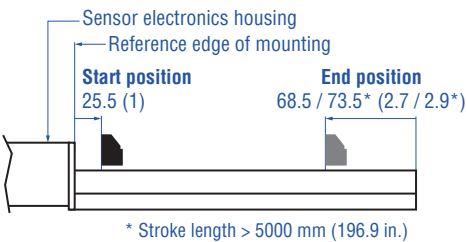

RD4-M / -T / -G with ring magnet / U-magnet

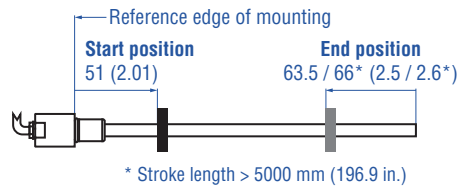

RH with ring magnet / U-magnet

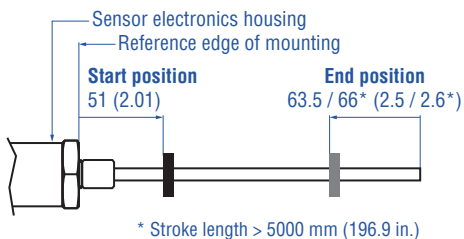

RD4-C / -D with ring magnet / U-magnet

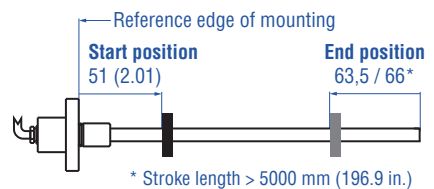

Manuals, Software & 3D models
available at: www.mtssensors.com

Controlling design dimensions are in millimeters and
measurements in () are in inches

Temposonics® R-Series

Brief Instructions

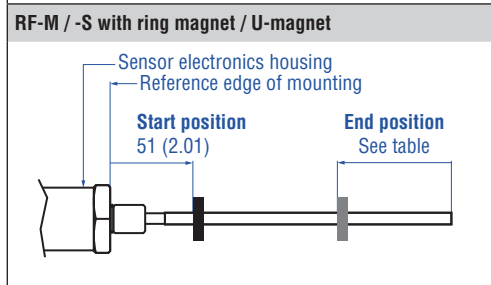
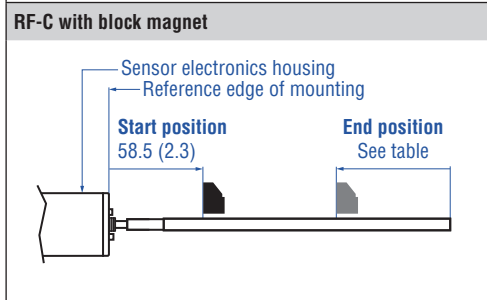
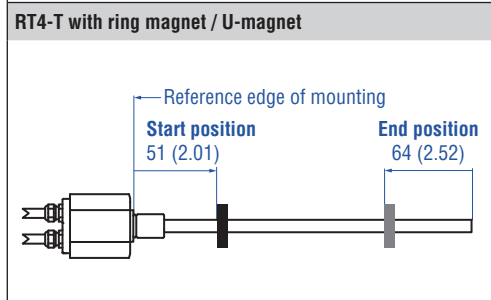
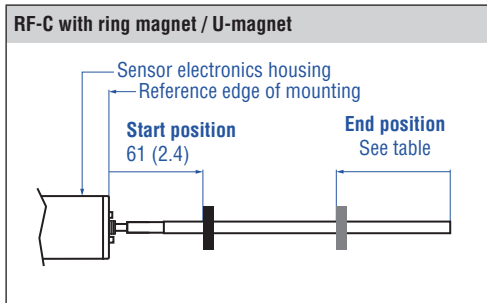
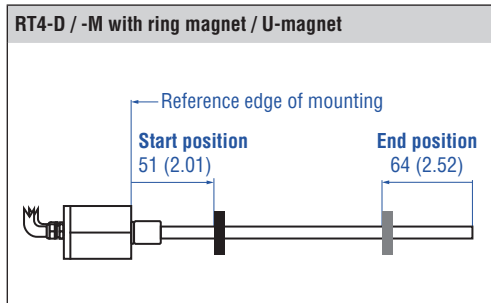

Stroke length RF	Tolerance of total length	End position of ring magnet / U-Magnet	End position of block magnet
Up to 7620 mm (300.00 in.)	+8 mm (0.31 in.) / -5 mm (0.20 in.)	94 mm (3.70 in.)	96.5 mm (3.8 in.)
Up to 10,000 mm (393.70 in.)	+15 mm (0.59 in.) / -15 mm (0.59 in.)	100 mm (3.94 in.)	102.5 mm (4.04 in.)
Up to 15,000 mm (590.55 in.)	+15 mm (0.59 in.) / -30 mm (1.18 in.)	120 mm (4.72 in.)	122.5 mm (4.82 in.)
Up to 20,000 mm (787.00 in.)	+15 mm (0.59 in.) / -45 mm (1.77 in.)	140 mm (5.51 in.)	142.5 mm (5.61 in.)

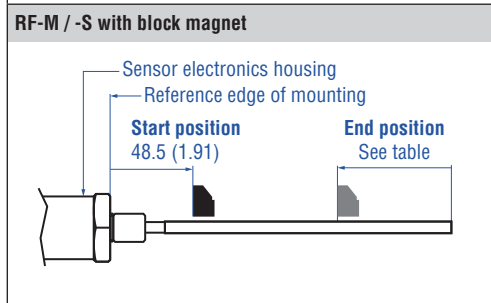

NOTICE

The sensor can be operated in any orientation.

Controlling design dimensions are in millimeters and measurements in () are in inches

Manuals, Software & 3D models available at: www.mtssensors.com

4.3 Multi-position measurement distances

Multi-position measurements are output signal dependent possible. The acquisition of up to 20 positions or 5 positions and their velocities.

Please note that the stroke length influences the maximum number of magnets.

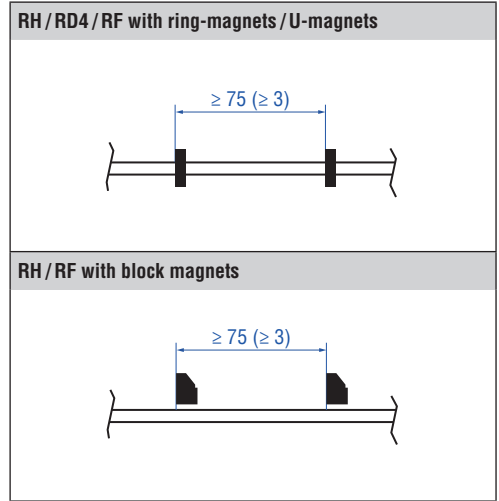
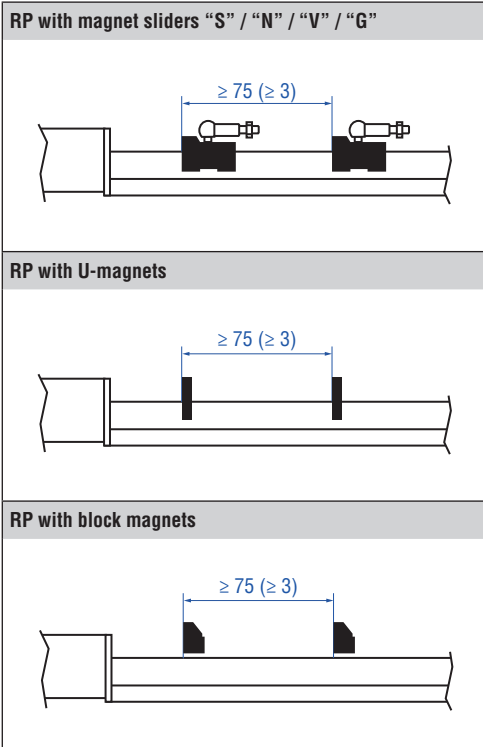

NOTICE

Use magnets of the same type for multi-position measurement, e.g. 2 × U-magnets (part no. 251 416-2).

Temposonics® R-Series

Brief Instructions

5. Electrical connections and LED status

Placement of installation and cabling have decisive influence on the sensor's electromagnetic compatibility (EMC). Hence correct installation of this active electronic system and the EMC of the entire system must be ensured by using suitable metal connectors, shielded cables and grounding. Overvoltages or faulty connections can damage its electronics despite protection against wrong polarity.

NOTICE

1. Do not mount the sensors in the area of strong magnetic or electric noise fields.
2. Never connect / disconnect the sensor when voltage is applied.
3. **RD4** and **RT4**: Sensor rod and connecting cable have to be mounted in a metal housing (e.g. in a cylinder).
4. **RF**: Wave guide of the sensor has to be embedded in an EMC-sealed and grounded housing.

Instructions for connection

- Use low-resistance twisted pair and shielded cables and connect the shield to ground externally via the controller equipment.
- Keep control and signal cables separate from power cables and sufficiently far away from motor cables, frequency inverters, valve lines, relays, etc.
- Use only connectors with metal housing and connect the shielding to the connector housing.
- Keep the connection surface at both shielding ends as large as possible.
- Keep all non-shielded leads as short as possible.
- Keep the earth connection as short as possible with a large cross section. Avoid ground loops.
- With potential differences between machine and electronics earth connections, no compensating currents are allowed to flow across the cable shielding.

Recommendation:

Install potential compensating leads with large cross section, or use cables with separate double shielding, and connect only one end of the shield.

- Use only stabilized power supplies in compliance with the specified connecting values.

Grounding of profile and rod sensors

Connect the sensor electronics housing to machine ground. Ground sensor types RP, RH, RD4, RT4 and RF via ground lug. In addition you can ground the sensor type RH via thread.

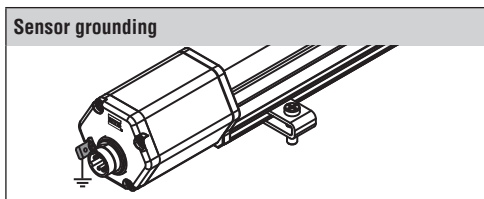

LED status	Outputs
	<ul style="list-style-type: none"> • Analog • CANbus • EtherCAT® • SSI • Profibus • Profinet
	<ul style="list-style-type: none"> • EtherNet/IP™ • Powerlink
	<ul style="list-style-type: none"> • DeviceNet

Manuals, Software & 3D models
available at: www.mtssensors.com

5.1 Analog

D60

Signal + power supply

M16 male connector	Output	Pin	Function
 <p>View on sensor</p>	1	1	Position: Magnet 1
		2	DC Ground
	2*	3	Position: Magnet 2 or Velocity: Magnet 1
		4	DC Ground
		5	+24 VDC (-15 / +20 %)
		6	DC Ground (0 V)

* order dependent

RXX / HXX

Signal + power supply

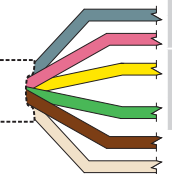
Cable	Output	Color	Function
	1	GY	Position: Magnet 1
		PK	DC Ground
	2*	YE	Position: Magnet 2 or Velocity: Magnet 1
		GN	DC Ground
		BN	+24 VDC (-15 / +20 %)
		WH	DC Ground (0 V)

* order dependent

Analog LED status

Green	Red	Information
● ON	○ OFF	Normal function
● ON	● ON	No magnet / wrong quantity of magnets
● ON	◐ Flashing	Magnet is not in the set range
◐ Flashing	● ON	Programming mode

NOTICE

Mind the hazard of short circuits!

When using only output 1, insulation of the yellow and green cores (output 2) is indispensable.
Recommendation: Provide terminals for output 2 in the control cabinet, because the leads are eventually required in case of sensor programming.

5.2 SSI

D70

Signal + power supply

M16 male connector	Color	Function
 <p>View on sensor</p>	1	Data (-)
	2	Data (+)
	3	Clock (+)
	4	Clock (-)
	5	+24 VDC (-15 / +20 %)
	6	DC Ground (0 V)
	7	Not connected

HXX / PXX / RXX

Signal + power supply

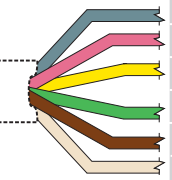

Cable	Color	Function
	GY	Data (-)
	PK	Data (+)
	YE	Clock (+)
	GN	Clock (-)
	BN	+24 VDC (-15 / +20 %)
	WH	DC Ground (0 V)



SSI LED status

Green	Red	Information
● ON	○ OFF	Normal function
● ON	● ON	No magnet / wrong quantity of magnets
◐ Flashing	● ON	Programming mode
● ON	◐ Flashing	Sensor not synchronous*



*for synchronous measurement only

5.3 Profibus

D53		
Signal		
M12 male connector (B-coded)	Pin	Function
 <p>View on sensor</p>	1	Not connected
	2	RxD / TxD-N (bus)
	3	Not connected
	4	RxD / TxD-P (bus)
	5	Shield
M12 female connector (B-coded)	Pin	Function
 <p>View on sensor</p>	1	VP +5 VDC (for bus termination)
	2	RxD / TxD-N (bus)
	3	Data GND (for bus termination)
	4	RxD / TxD-P (bus)
	5	Shield
Power supply		
M8 male connector	Pin	Function
 <p>View on sensor</p>	1	+24 VDC (-15 / +20 %)
	2	Not connected
	3	DC Ground (0 V)
	4	Not connected

AXX		
Signal		
Cable	Color	Function
	GN	RxD / TxD-N (bus)
	RD	RxD / TxD-P (bus)
Cable	Color	Function
	GN	RxD / TxD-N (bus)
	RD	RxD / TxD-P (bus)
Power supply		
M8 male connector	Pin	Function
 <p>View on sensor</p>	1	+24 VDC (-15 / +20 %)
	2	Not connected
	3	DC Ground (0 V)
	4	Not connected

Profibus LED status				
Green		Red		Information
●	ON	○	OFF	Normal function
●	ON	●	ON	No magnet / wrong quantity of magnets
●	Flashing	○	OFF	Waiting for master parameters
●	Flashing	●	ON	Programming mode

D63		
Signal + power supply		
M16 male connector	Pin	Function
 <p>View on sensor</p>	1	RxD / TxD-N (bus)
	2	RxD / TxD-P (bus)
	3	Not connected
	4	Not connected
	5	+24 VDC (-15 / +20 %)
	6	DC Ground (0 V)
M16 female connector	Pin	Function
 <p>View on sensor</p>	1	RxD / TxD-N (bus)
	2	RxD / TxD-P (bus)
	3	Data GND (terminal resistor)
	4	VP +5 VDC (terminal resistor)
	5	+24 VDC (-15 / +20 %)
	6	DC Ground (0 V)

NOTICE

- Use only bus cables, according to regulations of the Profibus User Organisation (www.profibus.com).
- Bus lines must be installed according to Profibus guideline.
- Bus wiring must be terminated at both ends.

5.4 CANbus

D54

Signal

M12 male connector (A-coded)	Pin	Function
 <p>View on sensor</p>	1	Shield
	2	Not connected
	3	Not connected
	4	CAN_H
	5	CAN_L

M12 female connector (A-coded)

Pin	Function
1	Shield
2	Not connected
3	Not connected
4	CAN_H
5	CAN_L

Power supply

M8 male connector	Pin	Function
 <p>View on sensor</p>	1	+24 VDC (-15 / +20 %)
	2	Not connected
	3	DC Ground (0 V)
	4	Not connected

D55

Signal + power supply

M12 male connector (A-coded)	Pin	Function
 <p>View on sensor</p>	1	Shield
	2	+24 VDC (-15 / +20 %)
	3	DC Ground (0 V)
	4	CAN_H
	5	CAN_L

M12 female connector (A-coded)

Pin	Function
1	Shield
2	+24 VDC (-15 / +20 %)
3	DC Ground (0 V)
4	CAN_H
5	CAN_L

D60

Signal + power supply

M16 male connector	Pin	Function
 <p>View on sensor</p>	1	CAN_L
	2	CAN_H
	3	Not connected
	4	Not connected
	5	+24 VDC (-15 / +20 %)
	6	DC Ground (0 V)

D62

Signal + power supply

M16 male connector	Pin	Function
 <p>View on sensor</p>	1	CAN_L
	2	CAN_H
	3	Not connected
	4	Not connected
	5	+24 VDC (-15 / +20 %)
	6	DC Ground (0 V)

M16 male connector

Pin	Function
1	CAN_L
2	CAN_H
3	Not connected
4	Not connected
5	+24 VDC (-15 / +20 %)
6	DC Ground (0 V)

PXX / HXX

Signal + power supply

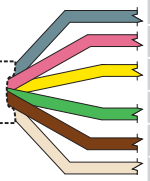
Cable	Color	Function
	GY	CAN_L
	PK	CAN_H
	YE	Not connected
	GN	Not connected
	BN	+24 VDC (-15 / +20 %)
	WH	DC Ground (0 V)

CANbus LED status

Green	Red	Information
● ON	○ OFF	Normal function
● ON	● ON	No magnet / wrong quantity of magnets
○ OFF	● ON	Initialization error
◐ Flashing	◐ Flashing	Operating voltage out of range

Temposonics® R-Series

Brief Instructions

5.5 DeviceNet

D51

Signal + power supply

M12 male connector (A-coded)	Pin	Function
 <p>View on sensor</p>	1	Shield
	2	+24 VDC (-15 / +20 %)
	3	DC Ground (0 V)
	4	CAN_H
	5	CAN_L

DeviceNet LED status

Network status

Green	Red	Information
● ON	○ OFF	Normal function
● Flashing	○ OFF	Waiting for instructions from DeviceNet master
○ OFF	● ON	Initialization error
○ OFF	● Flashing	No answer from DeviceNet master

Modul status

Green	Red	Information
● ON	○ OFF	Normal function
○ OFF	● ON	Magnet not detected

5.6 EtherCAT®

D56

Signal

M12 female connector (D-coded)	Pin	Function
 <p>View on sensor</p>	1	Tx (+)
	2	Rx (+)
	3	Tx (-)
	4	Rx (-)
	5	Not connected

M12 female connector (D-coded)	Pin	Function
 <p>View on sensor</p>	1	Tx (+)
	2	Rx (+)
	3	Tx (-)
	4	Rx (-)
	5	Not connected

Power supply



M8 male connector	Pin	Function
 <p>View on sensor</p>	1	+24 VDC (-15 / +20 %)
	2	Not connected
	3	DC Ground (0 V)
	4	Not connected

EtherCAT LED status

Green	Red	Information
● Flashing	○ OFF	Normal function
● Flashing	● ON	No magnet / wrong quantity of magnets

Further diagnostic functions can be programmed.

5.7 EtherNet/IP™

D56		
Signal		
M12 female connector (D-coded)	Pin	Function
 <p>View on sensor</p>	1	Tx (+)
	2	Rx (+)
	3	Tx (-)
	4	Rx (-)
	5	Not connected
M12 female connector (D-coded)	Pin	Function
 <p>View on sensor</p>	1	Tx (+)
	2	Rx (+)
	3	Tx (-)
	4	Rx (-)
	5	Not connected
Power supply		
M8 male connector	Pin	Function
 <p>View on sensor</p>	1	+24 VDC (-15 / +20 %)
	2	Used for DHCP reset only*
	3	DC Ground (0 V)
	4	Used for DHCP reset only*
* They should be independent of each other and floating (not grounded) under normal operation		

Ethernet/IP™ LED status			
Network status			
Green		Red	Information
● ON	○ OFF	○ OFF	Connection established
● Flashing	○ OFF	○ OFF	No connection
○ OFF	● ON	● ON	Unrecoverable error
○ OFF	● Flashing	● Flashing	Recoverable error
Port 1 (In)			
Green		Red	Information
● ON	○ OFF	○ OFF	LINK activity on port 1
● Flickers	○ OFF	○ OFF	Data transfer on port 1
○ OFF	● ON	● ON	No magnet / wrong quantity of magnets
Port 2 (Out)			
Green		Red	Information
● ON	○ OFF	○ OFF	LINK activity on port 2
● Flickers	○ OFF	○ OFF	Data transfer on port 2
Module status			
Green		Red	Information
● ON	○ OFF	○ OFF	IP address configured
● Flashing	○ OFF	○ OFF	IP address not configured
○ OFF	● Flashing	● Flashing	Duplicate of IP address recognized

Temposonics® R-Series

Brief Instructions

5.8 Powerlink

D56

Signal

M12 female connector (D-coded)

Pin Function



View on sensor

1	Tx (+)
2	Rx (+)
3	Tx (-)
4	Rx (-)
5	Not connected

M12 female connector (D-coded)

Pin Function



View on sensor

1	Tx (+)
2	Rx (+)
3	Tx (-)
4	Rx (-)
5	Not connected

Power supply

M8 male connector

Pin Function



View on sensor

1	+24 VDC (-15 / +20 %)
2	Not connected
3	DC Ground (0 V)
4	Not connected

Powerlink LED status

Bus status

Green	Red	Information
● ON	○ OFF	Connection established

Port 1

Green	Red	Information
● ON	○ OFF	LINK activity on port 1
● Flashing	○ OFF	Data activity on port 1
○ OFF	● ON	Missing magnet

Port 2

Green	Red	Information
● ON	○ OFF	LINK activity on port 2
● Flashing	○ OFF	Data activity on port 2

Bus error

Green	Red	Information
○ OFF	● ON	Fault detected

5.9 Profinet

D58

Signal

M12 female connector (D-coded)

Pin Function



View on sensor

1	Tx (+)
2	Rx (+)
3	Tx (-)
4	Rx (-)
5	Not connected

M12 female connector (D-coded)

Pin Function



View on sensor

1	Tx (+)
2	Rx (+)
3	Tx (-)
4	Rx (-)
5	Not connected

Power supply

M12 male connector

Pin Function



View on sensor

1	+24 VDC (-15 / +20 %)
2	Do not connect! *
3	DC Ground (0 V)
4	Do not connect! *

* As a connection to this pin may influence the correct startup of sensor.

Profinet LED status

Green Red Information

● ON	○ OFF	Normal function
● ON	● ON	No connection to master
● ON	● Flashing	Parameterization failed
○ OFF	● ON	Warning! (illegal supply voltage / wrong quantity of magnets)

UNITED STATES 3001 Sheldon Drive
Temposonics, LLC Cary, N.C. 27513
Americas & APAC Region Phone: +1 919 677-0100
E-mail: info.us@temposonics.com

GERMANY Auf dem Schüffel 9
Temposonics 58513 Lüdenscheid
GmbH & Co. KG Phone: +49 2351 9587-0
EMEA Region & India E-mail: info.de@temposonics.com

ITALY Phone: +39 030 988 3819
Branch Office E-mail: info.it@temposonics.com

FRANCE Phone: +33 6 14 060 728
Branch Office E-mail: info.fr@temposonics.com

UK Phone: +44 79 44 15 03 00
Branch Office E-mail: info.uk@temposonics.com

SCANDINAVIA Phone: +46 70 29 91 281
Branch Office E-mail: info.sca@temposonics.com

CHINA Phone: +86 21 2415 1000 / 2415 1001
Branch Office E-mail: info.cn@temposonics.com

JAPAN Phone: +81 3 6416 1063
Branch Office E-mail: info.jp@temposonics.com

Document part number:
551516 Revision G (EN) 02/2018



temposonics.com