

## RD4 Powerlink V2 Data Sheet

- Detached sensor electronics
- Mounting in applications with limited space
- Diagnostics LEDs



## MEASURING TECHNOLOGY

The absolute, linear position sensors provided by MTS Sensors rely on the company's proprietary Temposonics® magnetostrictive technology, which can determine position with a high level of precision and robustness. Each Temposonics® position sensor consists of a ferromagnetic waveguide, a position magnet, a strain pulse converter and supporting electronics. The magnet, connected to the object in motion in the application, generates a magnetic field at its location on the waveguide. A short current pulse is applied to the waveguide. This creates a momentary radial magnetic field and torsional strain on the waveguide. The momentary interaction of the magnetic fields releases a torsional strain pulse that propagates the length of the waveguide. When the ultrasonic wave reaches the end of the waveguide it is converted into an electrical signal. Since the speed of the ultrasonic wave in the waveguide is precisely known, the time required to receive the return signal can be converted into a linear position measurement with both high accuracy and repeatability.

## RD4 SENSOR

Robust, non-contact and wear free, the Temposonics® linear position sensors provide best durability and accurate position measurement solutions in harsh industrial environments. The position measurement accuracy is tightly controlled by the quality of the waveguide which is manufactured by MTS Sensors. The position magnet is mounted on the moving machine part and travels contactlessly over the sensor rod with the built-in waveguide.

Temposonics® RD4 is a high-performance position sensor with detached electronics: the sensor rod with the built-in waveguide is connected via a cable to the electronics. This sensor design allows easy mounting in limited spaces while isolating the sensor electronics from high temperatures, high vibration and shock, or other environmental extremes. The sensor can be integrated into a hydraulic cylinder. Typical applications are steel mills, wood- and metalworking industries.

## POWERLINK V2 INTERFACE

Temposonics® position sensors fulfil the requirements of the Ethernet Powerlink Standardization Group (EPSG). Ethernet Powerlink V2 is an open protocol based on the Ethernet-standard according to IEEE 802.3. It is an extension to the Ethernet protocol which allows real-time data communication. Within the Ethernet Powerlink protocol a CANopen based communication protocol for user data is specified. Powerlink is the only Ethernet protocol that meets the high real-time requirements with a software-only concept. No special Powerlink hardware is needed.

Delivered information:

- Absolute position
- Velocity
- Status

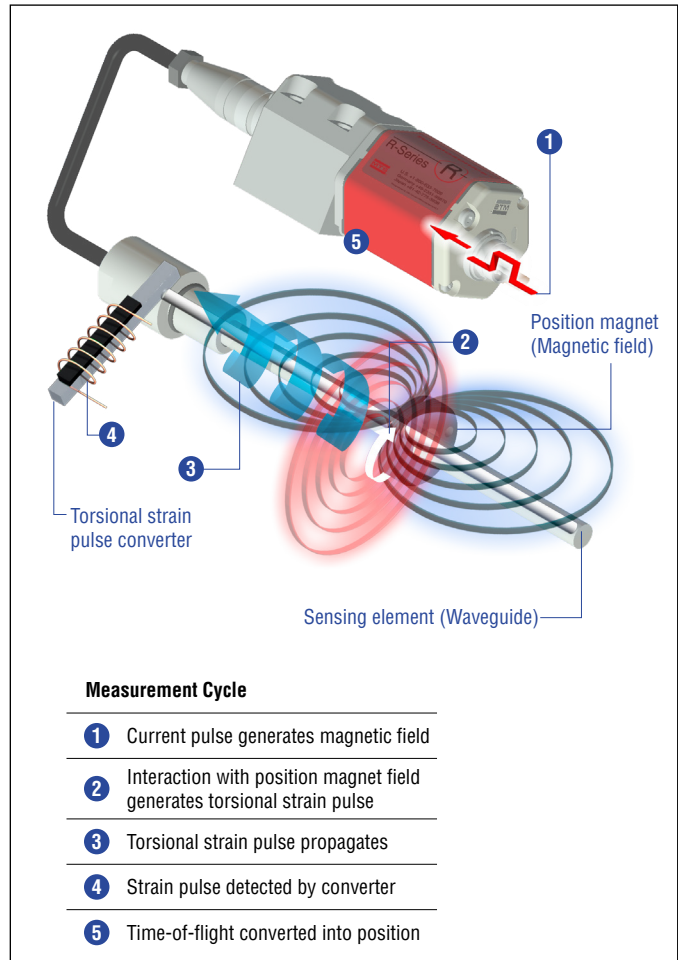

Fig. 1: Principle of operation: Time-based magnetostrictive position sensing principle



Fig. 2: Typical application: Steel mills and metalworking industry

## TECHNICAL DATA

Output				
Interface	Ethernet POWERLINK			
Data protocol	POWERLINK V2 according to IEEE 802.3			
Measured value	Position, velocity / option: multi-position measurement (2...4 positions) <sup>1</sup>			
Measurement parameters				
Resolution	1 µm, 2 µm, 5 µm, 10 µm, 50 µm or 100 µm (selectable)			
Cycle time	Stroke length	up to 2400 mm	up to 4800 mm	up to 5080 mm
	Cycle time	1.0 ms	2.0 ms	4.0 ms
Linearity <sup>2,3</sup>	< ±0.02 % F.S. (minimum ±50 µm)			
Repeatability	< ±0.001 % F.S. (minimum ±2.5 µm) typical			
Hysteresis	< 4 µm			
Operating conditions				
Operating temperature electronics	-40...+75 °C (-40...+167 °F)			
Humidity	90 % relative humidity, no condensation			
Ingress protection for sensor electronics <sup>4</sup>	IP67 (housing and connectors correctly fitted)			
Ingress protection sensor rod with connecting cable for side cable entry <sup>4</sup>	IP65 (connectors correctly fitted)			
Ingress protection sensor rod with single wires and flat connector with bottom cable entry <sup>4</sup>	IP30			
Shock test	100 g (single shock), IEC standard 60068-2-27			
Vibration test	10 g / 10...2000 Hz, IEC standard 60068-2-6 (excluding resonant frequencies)			
EMC test <sup>5</sup>	Electromagnetic emission according to EN 61000-6-3			
	Electromagnetic immunity according to EN 61000-6-2			
Operating pressure	350 bar (5076 psi), 700 bar (10,153 psi) peak (at 10 × 1 min)			
Magnet movement velocity	Any			
Design / Material				
Sensor electronics housing	Aluminum			
Sensor flange	Stainless steel 1.4305 (AISI 303)			
Sensor rod	Stainless steel 1.4306 (AISI 304L)			
Stroke length	25...5080 mm (1...200 in.)			
Mechanical mounting				
Mounting position	Any			
Mounting instruction	Please consult the technical drawings and the operation manual (document number: <a href="#">551657</a> )			
Electrical connection				
Connection type	2 × M12 female connector (5 pin), 1 × M8 male connector (4 pin)			
Operating voltage <sup>6</sup>	+24 VDC (-15 / +20 %)			
Ripple	≤ 0.28 V <sub>pp</sub>			
Current consumption <sup>6</sup>	110 mA typical			
Dielectric strength	500 VDC (DC ground to machine ground)			
Polarity protection	Up to -30 VDC			
Overvoltage protection	Up to 36 VDC			

1/ The number of magnets depends on the stroke length

2/ With position magnet # 251 416-2

3/ For rod style »S« the linearity deviation can be higher in the first 30 mm (1.2 in.) of stroke length

4/ The IP rating is not part of the UL approval

5/ Measuring rod and connecting cable mounted inside metal housing

6/ Power supply must be able to provide current of 1 A for power up process

## TECHNICAL DRAWINGS

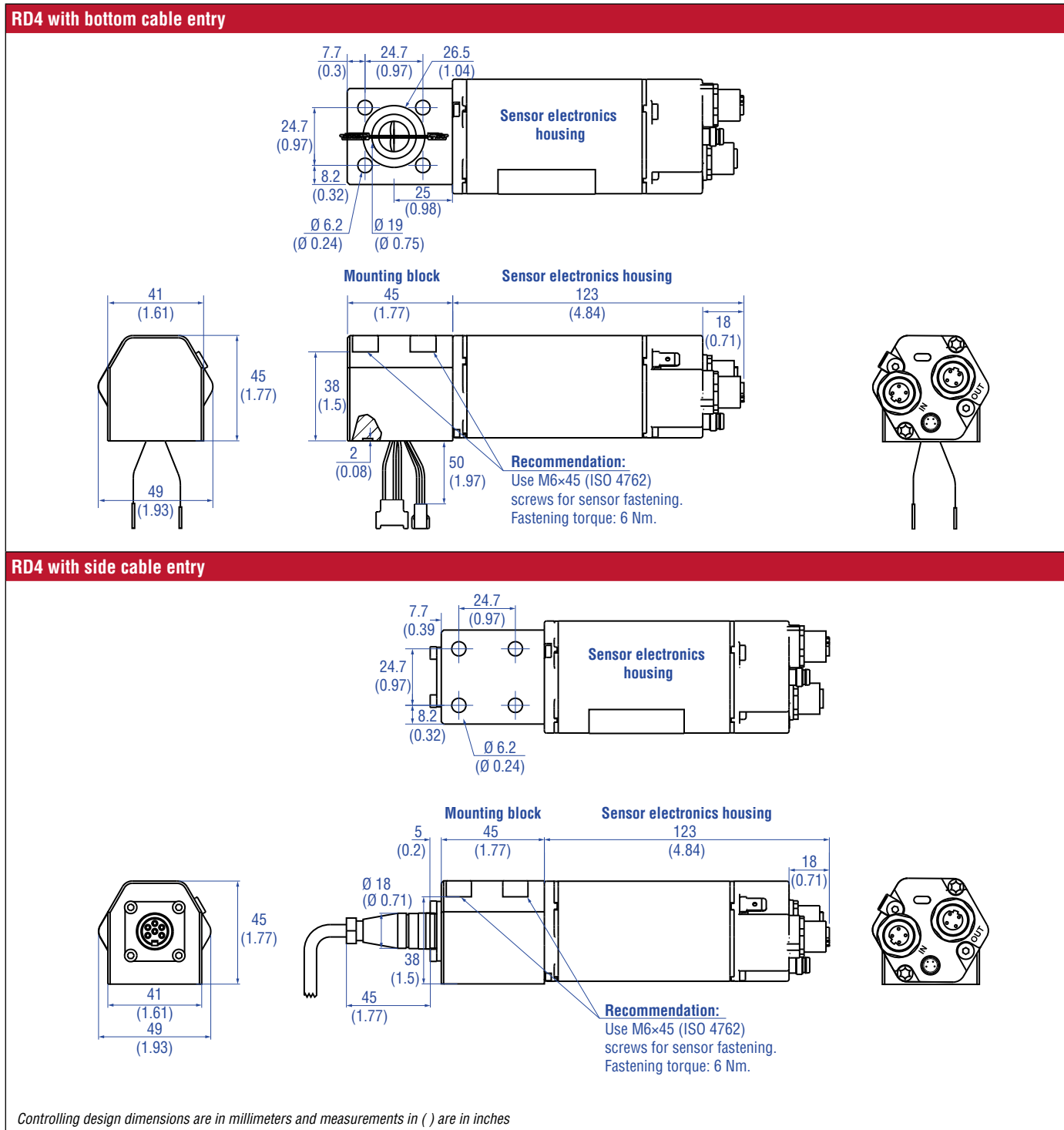
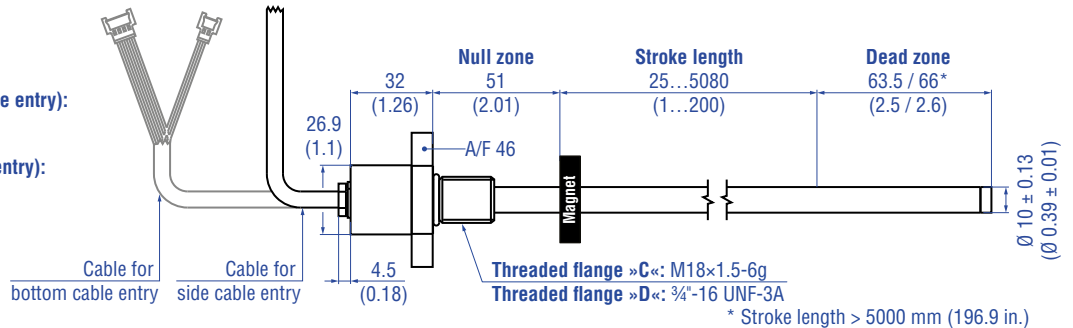

Fig. 3: Temposonics® RD4 sensor electronics housings

**Threaded flange »C« & »D« (for bottom- or side entry)**

**PUR cable:**  
Ø 6 (Ø 0.24)  
**Bending radius:**  
> 24 (> 0.94)  
**Cable length (bottom cable entry):**  
65 / 170 / 230 / 350  
(2.6 / 6.7 / 9.1 / 13.8)  
**Cable length (side cable entry):**  
250 / 400 / 600  
(9.8 / 15.7 / 23.6)



**Threaded flange »G« (for bottom- or side entry)**

**PUR cable:**  
Ø 6 (Ø 0.24)  
**Bending radius:**  
> 24 (> 0.94)  
**Cable length (bottom cable entry):**  
65 / 170 / 230 / 350  
(2.6 / 6.7 / 9.1 / 13.8)  
**Cable length (side cable entry):**  
250 / 400 / 600  
(9.8 / 15.7 / 23.6)

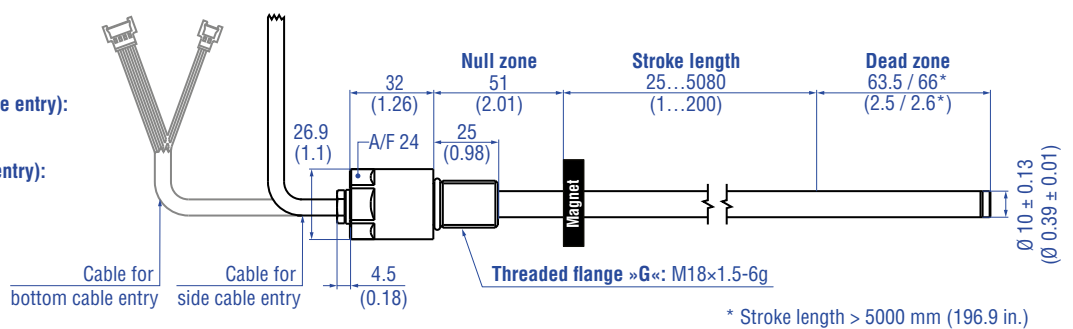

**Threaded flange »M« & »T« (for bottom- or side entry)**

**PUR cable:**  
Ø 6 (Ø 0.24)  
**Bending radius:**  
> 24 (> 0.94)  
**Cable length (bottom cable entry):**  
65 / 170 / 230 / 350  
(2.6 / 6.7 / 9.1 / 13.8)  
**Cable length (side cable entry):**  
250 / 400 / 600  
(9.8 / 15.7 / 23.6)

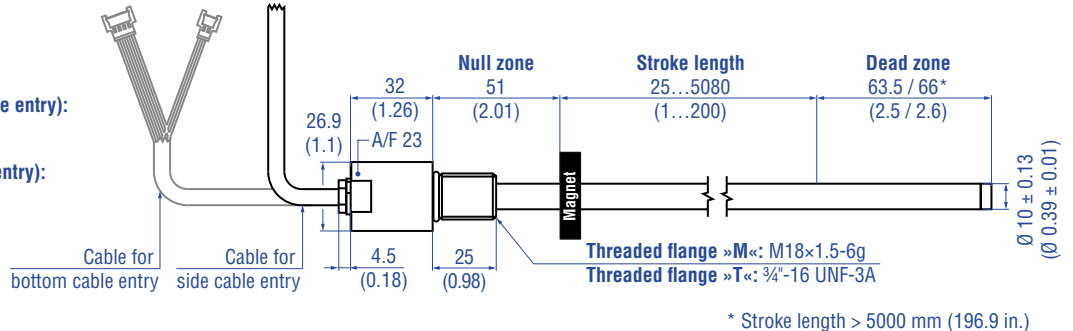

**Pressure fit flange »S« (for bottom- or side entry)**

**PUR cable:**  
Ø 6 (Ø 0.24)  
**Bending radius:**  
> 24 (> 0.94)  
**Cable length (bottom cable entry):**  
65 / 170 / 230 / 350  
(2.6 / 6.7 / 9.1 / 13.8)  
**Cable length (side cable entry):**  
250 / 400 / 600  
(9.8 / 15.7 / 23.6)

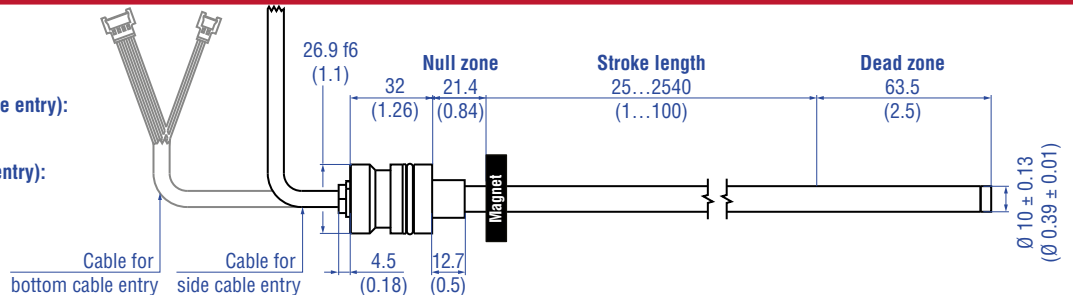

Controlling design dimensions are in millimeters and measurements in ( ) are in inches

Fig. 4: Temposonics® RD4 flanges

## CONNECTOR WIRINGS



D56		
Signal		
M12 female connector (D-coded)	Pin	Function
 <p>View on sensor</p>	1	Tx (+)
	2	Rx (+)
	3	Tx (-)
	4	Rx (-)
	5	Not connected
M12 female connector (D-coded)	Pin	Function
 <p>View on sensor</p>	1	Tx (+)
	2	Rx (+)
	3	Tx (-)
	4	Rx (-)
	5	Not connected
Power supply		
M8 male connector	Pin	Function
 <p>View on sensor</p>	1	+24 VDC (-15 / +20 %)
	2	Not connected
	3	DC Ground (0 V)
	4	Not connected

Fig. 5: Connector wirings D56

**FREQUENTLY ORDERED ACCESSORIES** – Additional options available in our [Accessories Guide](#)  [551444](#)

Position magnets			
			
<p><b>Ring magnet OD33</b> Part no. 201 542-2</p>	<p><b>Ring magnet OD25.4</b> Part no. 400 533</p>	<p><b>Ring magnet</b> Part no. 402 316</p>	<p><b>U-magnet OD33</b> Part no. 251 416-2</p>
<p>Material: PA ferrite GF20 Weight: Approx. 14 g Surface pressure: Max. 40 N/mm<sup>2</sup> Fastening torque for M4 screws: 1 Nm Operating temperature: -40...+105 °C (-40...+221 °F)</p>	<p>Material: PA ferrite Weight: Approx. 10 g Surface pressure: Max. 40 N/mm<sup>2</sup> Operating temperature: -40...+105 °C (-40...+221 °F)</p>	<p>Material: PA ferrite coated Weight: Approx. 13 g Surface pressure: Max. 20 N/mm<sup>2</sup> Operating temperature: -40...+100 °C (-40...+212 °F)</p>	<p>Material: PA ferrite GF20 Weight: Approx. 11 g Surface pressure: Max. 40 N/mm<sup>2</sup> Fastening torque for M4 screws: 1 Nm Operating temperature: -40...+105 °C (-40...+221 °F)</p>

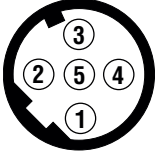
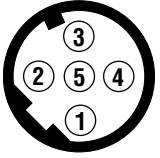

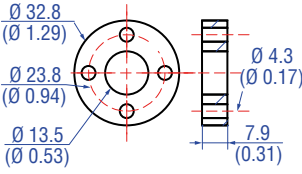
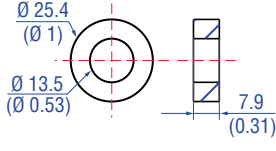
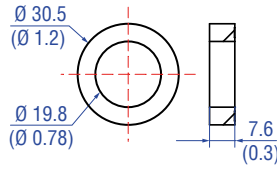
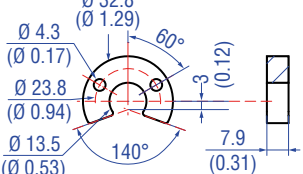
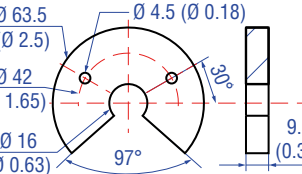
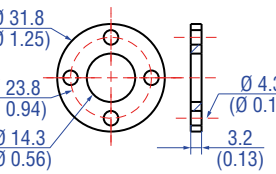
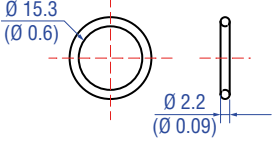
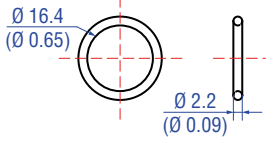
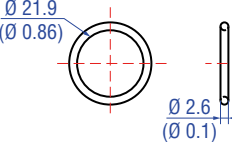
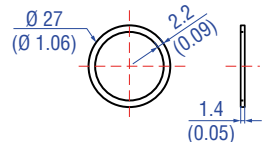
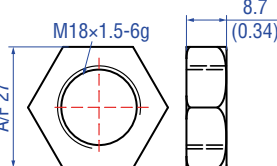
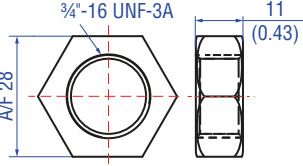

Positions magnet	Magnet spacer	O-rings	O-rings
			
<p><b>U-magnet OD63.5</b> Part no. 201 553</p>	<p><b>Magnet spacer</b> Part no. 400 633</p>	<p><b>O-ring for threaded flange</b> M18x1.5-6g Part no. 401 133</p>	<p><b>O-ring for threaded flange</b> ¾"-16 UNF-3A Part no. 560 315</p>
<p>Material: PA 66-GF30, magnets compound-filled Weight: Approx. 26 g Surface pressure: 20 N/mm<sup>2</sup> Fastening torque for M4 screws: 1 Nm Operating temperature: -40...+75 °C (-40...+167 °F)</p>	<p>Material: Aluminum Weight: Approx. 5 g Surface pressure: Max. 20 N/mm<sup>2</sup> Fastening torque for M4 screws: 1 Nm</p>	<p>Material: Fluoroelastomer Durometer: 75 ± 5 Shore A Operating temperature: -40...+204 °C (-40...+400 °F)</p>	<p>Material: Fluoroelastomer Durometer: 75 ± 5 Shore A Operating temperature: -40...+204 °C (-40...+400 °F)</p>

O-rings	Mounting accessories		
			
<p><b>O-ring for pressure fit flange Ø 26.9 mm</b> Part no. 560 705</p>	<p><b>Back-up ring for pressure fit flange Ø 26.9 mm</b> Part no. 560 629</p>	<p><b>Hex jam nut M18x1.5-6g</b> Part no. 500 018</p>	<p><b>Hex jam nut ¾"-16 UNF-3A</b> Part no. 500 015</p>
<p>Material: Nitrile rubber Operating temperature: -53...+107 °C (-65...+225 °F)</p>	<p>Material: Polymyte Durometer: 90 Shore A</p>	<p>Material: Steel, zinc, plated</p>	<p>Material: Zinc plated with nylon insert</p>

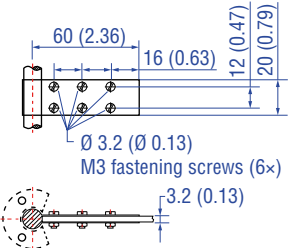
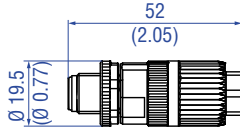
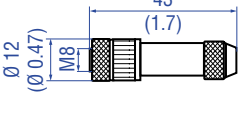
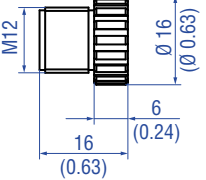
Controlling design dimensions are in millimeters and measurements in ( ) are in inches

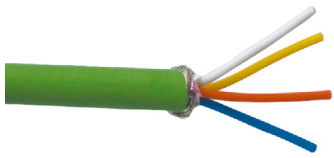

Mounting accessory		Cable connectors *	
			
<p><b>Fixing clip for rod with Ø 10 mm</b> Part no. 561 481</p> <p>Application: Used to secure sensor rods (Ø 10 mm (Ø 0.39 in.)) when using an U-magnet or block magnet Material: Brass, non-magnetic</p>	<p><b>M12 D-coded male connector (4 pin), straight</b> Part no. 370 523</p> <p>Material: Zinc nickel-plated Termination: Insulation-displacement Cable Ø: 5.5...7.2 mm (0.2...0.28 in.) Wire: 24 AWG – 22 AWG Operating temperature: –25...+85 °C (–13...+185 °F) Ingress protection: IP65 / IP67 (correctly fitted) Fastening torque: 0.6 Nm</p>	<p><b>M8 female connector (4 pin), straight</b> Part no. 370 504</p> <p>Material: CuZn nickel plated Termination: Solder Cable Ø: 3.5...5 mm (0.14...0.28 in.) Wire: 0.25 mm<sup>2</sup> Operating temperature: –40...+85 °C (–40...+185 °F) Ingress protection: IP67 (correctly fitted) Fastening torque: 0.5 Nm</p>	<p><b>M12 connector end cap</b> Part no. 370 537</p> <p>Female connectors M12 should be covered by this protective cap Material: Brass nickel-plated Ingress protection: IP67 (correctly fitted) Fastening torque: 0.39...0.49 Nm</p>

Cables			
			
<p><b>PUR cable</b> Part no. 530 125</p> <p>Material: PUR jacket; green Features: Cat 5, highly flexible Cable Ø: 6.5 mm (0.26 in.) Cross section: 2 × 2 × 0.35 mm<sup>2</sup> (22/7 AWG) Operating temperature: –20...+60 °C (–4...+140 °F)</p>	<p><b>PVC cable</b> Part no. 530 108</p> <p>Material: PVC jacket; gray Features: Shielded, flexible Cable Ø: 4.9 mm (0.19 in.) Cross section: 3 × 0.34 mm<sup>2</sup> Operating temperature: –30...+80 °C (–22...+176 °F)</p>	<p><b>Cable with M12 D-coded male connector (4 pin), straight – M12 D-coded, male connector (4 pin), straight</b> Part no. 530 064</p> <p>Material: PUR jacket; green Features: Cat 5e Cable length: 5 m (16.4 ft) Cable Ø: 6.5 mm (0.26 in.) Ingress protection: IP65, IP67, IP68 (correctly fitted) Operating temperature: –30...+70 °C (–22...+158 °F)</p>	<p><b>Cable with M12 D-coded male connector (4 pin), straight – RJ45 male connector, straight</b> Part no. 530 065</p> <p>Material: PUR jacket; green Features: Cat 5e Cable length: 5 m (16.4 ft) Cable Ø: 6.5 mm (0.26 in.) Ingress protection M12 connector: IP67 (correctly fitted) Ingress protection RJ45 connector: IP20 (correctly fitted) Operating temperature: –30...+70 °C (–22...+158 °F)</p>

**NOTICE**

\* Follow the manufacturer's mounting instructions



## ORDER CODE

1	2	3	4	5	6	7	8	9	10	11	12	13	14	15	16	17	18	19	20	21	22
R	D	4										D	5	6	U	3	0	1			
a			b	c			d					e			f				g		

optional

a	Sensor model
R D 4	Detached sensor electronics

b	Design
C	Threaded flange M18×1.5-6g, A/F 46
D	Threaded flange ¾"-16 UNF-3A, A/F 46
G	Threaded flange M18×1.5-6g, A/F 24
M	Threaded flange M18×1.5-6g, A/F 23
S	Pressure fit flange Ø 26.9 mm f6
T	Threaded flange ¾"-16 UNF-3A, A/F 23

c	Integral cable of sensor rod
<b>For side cable entry on sensor electronics housing</b>	
D 1 S	PUR cable with M16 connector, length 250 mm (9.8 in.)
D 2 S	PUR cable with M16 connector, length 400 mm (15.7 in.)
D 3 S	PUR cable with M16 connector, length 600 mm (23.6 in.)
<b>For bottom cable entry on sensor electronics housing</b>	
R 2 B	PUR cable / wires with flat connector, length 65 mm (2.6 in.)
R 4 B	PUR cable / wires with flat connector, length 170 mm (6.7 in.)
R 5 B	PUR cable / wires with flat connector length 230 mm (9.1 in.)
R 6 B	PUR cable / wires with flat connector, length 350 mm (13.8 in.)

Operating voltage
+24 VDC (-15 / +20 %); Standard, not indicated in order code

d	Stroke length
X X X X M	Flange »C«, »D«, »G«, »M«, »T«: 0025...5080 mm Flange »S«: 0025...2540 mm

Standard stroke length (mm)*	Ordering steps
25... 500 mm	5 mm
500... 750 mm	10 mm
750...1000 mm	25 mm
1000...2500 mm	50 mm
2500...5080 mm	100 mm

X X X X U	Flange »C«, »D«, »G«, »M«, »T«: 001.0...200.0 in. Flange »S«: 001.0...100.0 in.
-----------	--

Standard stroke length (in.)*	Ordering steps
1... 20 in.	0.2 in.
20... 30 in.	0.4 in.
30... 40 in.	1.0 in.
40...100 in.	2.0 in.
100...200 in.	4.0 in.

e	Connection type
D 5 6	2 × M12 female connectors (5 pin), 1 × M8 male connector (4 pin)

f	Output
U 3 0 1	Powerlink V2

### Optional:

g	Magnet number for multi-position measurement <sup>7</sup>
Z 0 2	2 magnets
Z 0 3	3 magnets
Z 0 4	4 magnets

**NOTICE**  
Use magnets of the same type e.g. 2 × ring magnet (part no. 201 542-2 ) for multi-position measurement.

\*/ Non standard stroke lengths are available; must be encoded in 5 mm / 0.1 in. increments  
7/ Note: Specify magnet numbers for your sensing application and order separately

## DELIVERY

- RD4-C / -D / -G / -M / -T: Accessories have to be ordered separately
- RD4-S: Sensor, O-ring, back-up ring

Manuals, Software & 3D models available at:  
[www.mtssensors.com](http://www.mtssensors.com)

**UNITED STATES**  
**Temposonics, LLC**  
Americas & APAC Region  
3001 Sheldon Drive  
Cary, N.C. 27513  
Phone: +1 919 677-0100  
E-mail: [info.us@temposonics.com](mailto:info.us@temposonics.com)

---

**GERMANY**  
**Temposonics**  
**GmbH & Co. KG**  
EMEA Region & India  
Auf dem Schüffel 9  
58513 Lüdenscheid  
Phone: +49 2351 9587-0  
E-mail: [info.de@temposonics.com](mailto:info.de@temposonics.com)

---

**ITALY**  
Branch Office  
Phone: +39 030 988 3819  
E-mail: [info.it@temposonics.com](mailto:info.it@temposonics.com)

---

**FRANCE**  
Branch Office  
Phone: +33 6 14 060 728  
E-mail: [info.fr@temposonics.com](mailto:info.fr@temposonics.com)

---

**UK**  
Branch Office  
Phone: +44 79 21 83 05 86  
E-mail: [info.uk@temposonics.com](mailto:info.uk@temposonics.com)

---

**SCANDINAVIA**  
Branch Office  
Phone: +46 70 29 91 281  
E-mail: [info.sca@temposonics.com](mailto:info.sca@temposonics.com)

---

**CHINA**  
Branch Office  
Phone: +86 21 2415 1000 / 2415 1001  
E-mail: [info.cn@temposonics.com](mailto:info.cn@temposonics.com)

---

**JAPAN**  
Branch Office  
Phone: +81 3 6416 1063  
E-mail: [info.jp@temposonics.com](mailto:info.jp@temposonics.com)

**Document Part Number:**  
551787 Revision B (EN) 08/2018



ETHERNET   
**POWERLINK**

**[temposonics.com](http://temposonics.com)**