

L e v e l P l u s [®]

T a n k G a u g i n g S y s t e m s

Side Tank Indicator (STI)
Installation & Operation Manual



GENERAL INFORMATION

MTS PHONE NUMBERS

To place orders:	800-457-6620
Application questions:	800-457-6620
Service:	800-457-6620
Fax:	800-943-1145

SHIPPING ADDRESS

MTS Systems Corporation
Sensors Division
3001 Sheldon Drive
Cary, North Carolina 27513

HOURS

Monday - Friday

7:30 a.m. to 5:30 p.m. EST/EDT

<i>Section</i>	TABLE OF CONTENTS	<i>Page</i>
1.0	INTRODUCTION	1
1.1	Specifications	3
2.0	INSTALLATION	4
2.1	Mounting The Enclosure	5
2.2	Cable Requirements	7
2.3	Recommended Cable Types	17
2.4	How To Select Cables	21
2.5	Field Wiring Installation	30
2.6	Power Supply Requirements	34
2.7	Switch Settings	35
2.7.1	Default Setting	35
2.7.2	DIP Switch #1	36
2.7.3	DIP Switch #2 (Stand-Alone Mode — Commands/# of Gauges)	38
2.7.4	DIP Switch #2 (Network Mode — Address)	40
2.7.5	Push Button Switch #3	41
2.8	Initial Power Up	41
2.9	Display Contrast Adjustment	43
3.0	OPERATION	44
3.1	Stand-alone Mode	44
3.2	Network Mode	47
3.3	General Network Mode Protocol Information	49
3.4	Network Mode Timing Considerations	55
3.5	Command Protocol	60
3.6	LCD Display and Optional Back Light	82
3.7	Programming The STI	83
3.7.1	Programming Control Code and Mode Switch	84
3.7.2	Programming Alarm Set Points	86
3.7.3	Programming Custom Command Table	86
3.8	Error Codes	87
4.0	TROUBLESHOOTING AND MAINTENANCE	89
4.1	Cable Isolation and Connectivity Tests	91
4.2	Current Tests	91
4.3	Using Built-in Diagnostics	93
4.4	Replacing Printed Circuit Boards	95
4.5	Upgrading Firmware	96
	APPENDIX A - References	97

1.0 INTRODUCTION

The Side Tank Indicator (STI) is part of the MTS Level Plus® product line. It offers a liquid crystal display (LCD) to indicate tank conditions, an EIA-485 serial interface and a NEMA 4 type enclosure. The LCD consists of sixteen seven-segment characters and thirty-one special icons that indicate various tank conditions. The STI is compatible with other MTS Level Plus digital EIA-485 devices including:

- Direct Digital Access (DDA) tank gauges
- Level Plus Tank Gauge Monitor
- Level Plus System80 (LPS80)
- HT-100 Hand Held Terminal

The STI has two modes of operation.

1. Network Mode: In this mode, the STI represents one slave device on the multi-drop network controlled by a host device such as the Level Plus Tank Gauge Monitor or LPS80.

2. Stand-Alone Mode: In this mode the STI assumes the role of host and it is in control of the network. A single STI module can interrogate up to eight DDA tank gauges and display level and temperature data received from them.

The STI electronics include three printed circuit boards: the base board, the microprocessor board, and the display board. The standard STI housing is a NEMA 7 type enclosure. The cover has heat-treated glass, wrenching lugs and a neoprene gasket seal. The base board mounts to the bottom of the enclosure with four screws. The microprocessor and display PCBs form an “electronics module” (hereafter referred to as the module), which plugs into the base board mounted at the bottom of the enclosure. No screws or spacers are required to attach the module to the base board. The module is contained in a plastic shroud, and can be easily be removed so that field wiring can be installed. Field wiring is made to the P1 and P2 terminal blocks which are located on the base board, under the module.

The STI display and the DDA gauge when combined with a Level Plus Monitor (or with a PC that is running LPS80™ software) can be configured for various applications. This manual covers only the STI display. When necessary, you may need to consult manuals for the other devices when designing your tank gauging system.

Other manuals:

- Level Plus Tank Gauge Monitor Installation and Operation Manual (P/N 550421)
- DDA Tank Gauge Installation and Operation Manual (P/N 550164)
- Hand-Held Terminal (HT100) Operation Manual (P/N 550424)
- LPS80 Installation and Operation Manual (P/N 550429)

1.1 Specifications

Environmental:

Operating Temperature:	Electronics: -40 to 176°F (-40 to 80°C) LCD: 14 to 158°F (-10 to 70°C) Storage Temperature -40 to 185°F (-40 to 85°C)
Humidity:	0% to 100% R.H.*
Vibration:	TBD
Shock:	TBD

Mechanical:

Enclosure:	NEMA 4 (outdoor)*
Mounting:	Supported by rigid conduit or by customer provided bracket
Entry Points:	(2) - 3/4" NPT

Electrical:

Input Voltage:	24 to 26 Vdc
Sleep Mode Current:	1.5 mA maximum
Operating Current:	15 mA maximum
Back Light Current:	50 mA maximum (optional)
Display:	Custom Liquid Crystal Display
Display Precision:	±0.01" (decimal mode) ±1/16" (fractional mode)
Display Contrast:	User adjustable
Serial Interface:	EIA-485 8 - Bit ASCII MTS Protocol

Communications:

Baud Rate:	4800
Parity:	Even
Data Bits:	8
Stop Bits:	1

Safety Approvals (pending):

- Factory Mutual Research Corporation (FMRC) intrinsic safety approval for Class I, II, III, Division 1, Groups C, D, E, F, and G hazardous areas.
- FMRC dust ignition-proof for Class II and III, Division 1, Groups E, F, and G hazardous areas.
- FMRC approval for outdoor NEMA 4 locations*.

* With proper installation and conduit seals

2.0 INSTALLATION

STI installation has three phases: (1) mounting the enclosure, (2) wiring, (3) and setup. Each phase of installation will be discussed in detail. Guidelines will be presented for each phase. Before proceeding with the installation, identify the mode that you want the STI to operate in (i.e., Stand-alone or Network). If the STI is going to be operated in a hazardous environment, the system must be installed according to MTS drawing #650591. Special precautions are necessary when installing and operating the STI in an intrinsically safe environment. Throughout this manual, the appropriate instructions are dependent upon the mode of operation selected. Special instructions or recommendations are given when intrinsic safety is required. Pay special attention to the setup phase. In the setup phase, the user must set switch configurations defined by the mode of operation selected.

CAUTION:

Always verify that the power is OFF before installing or removing the Microprocessor / Display "module". Use caution when handling this assembly. Use static sensitive device handling procedures. Do not allow contaminants to enter the assembly when it is removed from the housing. Place the module in a safe, clean environment until installed.

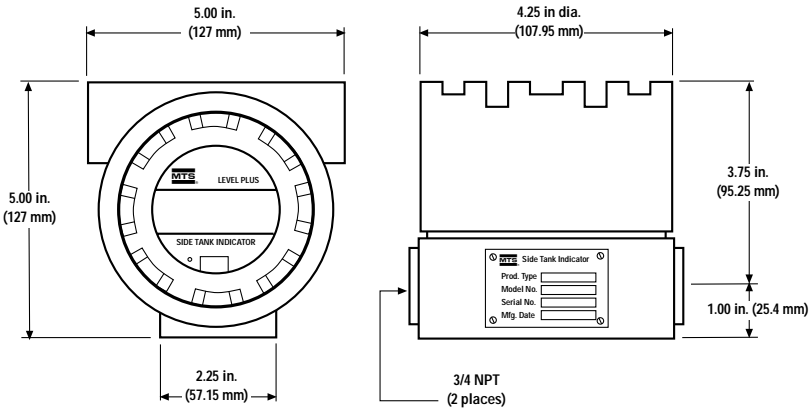

Figure 2.1 STI Enclosure Dimensions

2.1 Mounting The Enclosure

Mount the STI on a flat, vertical surface. Choose a surface that is free from obstructions that would make viewing the display or removing the cover difficult. Also, take into account the location of the sun or other light sources and how it might affect the ability to view the LCD display clearly (without glare). The STI enclosure should have plenty of clearance for protective conduits. The STI base board can be removed and rotated 90 degrees to allow the enclosure to be mounted in a vertical or horizontal position. Conduits should also be sealed and routed in a fashion to keep liquids from entering the enclosure. See figure 2.2.

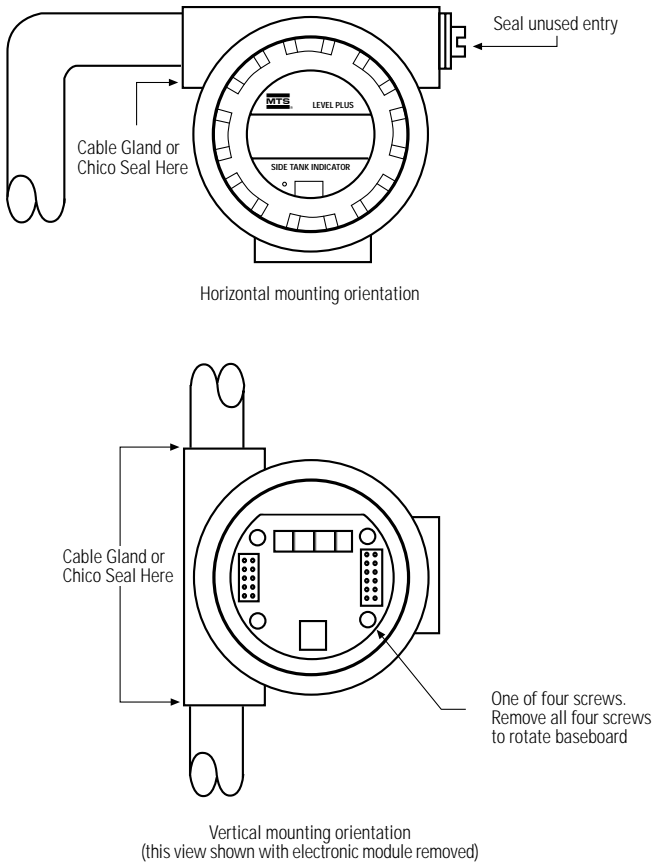

Figure 2.2 Mounting Orientation

CAUTION:

Chico seals or cable glands are recommended to keep moisture that may be present in the wiring conduits from entering the STI enclosure.

Before mounting, consult the National Electrical Code (NEC) and local electrical codes as necessary in reference to mounting NEMA 4 style enclosures. The enclosure is supported by protective conduit on one or two sides (3/4" NPT fittings). If the conduit is going to be connected on one side only, the other entry point on the opposite side must have a protective seal installed. Support the conduit as close as possible to the enclosure. If conduits are going to connect to both sides of the enclosure, then both conduits should be supported close to the STI unit.

Remove the cover from the enclosure by rotating it counter clockwise. Remove the electronics module from the enclosure by putting your thumb and index finger on the outer groove of the plastic shroud and pulling the module toward you. It is not necessary to remove any of the screws from the front bezel to remove the electronics module. Place the module in a safe place where it will be protected from dirt and other contaminants. It is recommended that the module be placed into the box that the STI was received in until it is needed. The base board should remain mounted in the enclosure. See MTS drawing 650597 in section 2.5 for wiring termination information.

Be careful when working with the enclosure to avoid damage to the base board inside the enclosure. After the enclosure has been mounted and the wiring completed, be sure to remove all metal shavings and/or wire strands that may cause damage to the STI electronics (use of a vacuum is recommended). Reinstall the electronics module, then replace the enclosure cover and tighten for proper seal.

2.2 Cable Requirements

The wiring connections for the DDA/STI system are based on an EIA-485 multidrop network as shown in Figure 2.3A and 2.3B. A typical network consists of the main wire trunk and individual tap connections to each STI display and DDA tank gauge. The main trunk as well as each tap connection consists of four wires that provide power and communications to each device on the network. The DDA/STI network is approved as an intrinsically safe system when used with the zener safety barriers listed on MTS installation drawing #650591 (in this section). The approvals cover Class I, II, III, Division 1, Groups C-G hazardous locations.

Safety barriers are used to limit the amount of energy (current x volts) available to devices on the EIA-485 network. The STI can achieve low power operation in Network Mode by staying in a sleep mode until a command is sent by the host device. In sleep mode, each STI draws about 1.5mA. When activated by a command (in Network Mode) or if operating in Stand-Alone Mode, the STI has a maximum current draw of 15 mA (does not include DDA tank gauge current). The network, including the safety barriers must be able to support the required energy to allow the DDA gauges and STI displays to work properly. The resistance of the safety barrier combined with the resistance of the cable then become the dominate factors in establishing the type and length of cables that can be used.

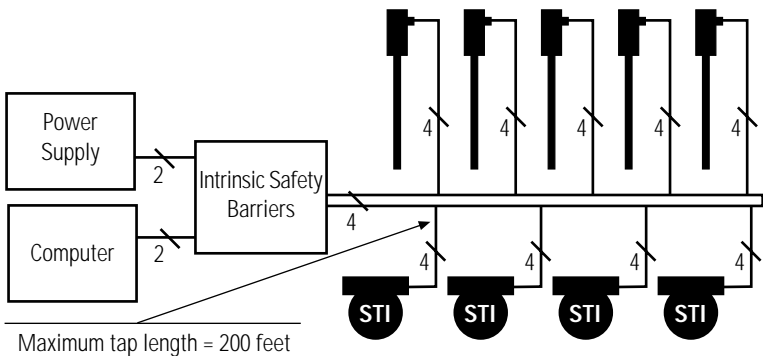

*Figure 2.3A DDA/STI Network
(Network Mode)*

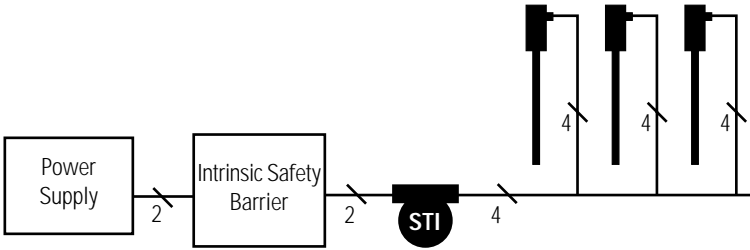

*Figure 2.3B DDA/STI Network
(Stand-alone mode)*

The capacitance of the cable also affects the network operation and must be considered when selecting cable for the network. The primary consideration is that the capacitance of the cable is an energy storage element and affects intrinsic safety aspects of the network. The secondary consideration is that the capacitance will attenuate the transmitted digital data. Since the communication baud rate is low (4800 baud), the voltage storage aspect of the cable is the dominate factor in determining cable types and lengths. In addition, each STI or DDA on the network represents a fixed capacitance on the network that must be included in the total capacitance of the network. The capacitance at the power supply input terminals of each device is 1600 pF and the communication input terminals is 4000 pF. In all applications, the total capacitance of the cables and the total capacitance of all the DDA gauges and STIs on the network must be less than the allowable capacitance (C_a) specified for the safety barriers.

The inductance of the cable similarly affects the intrinsic safety of the network and must be considered when making a cable selection. The inductance of the cable is an energy storage element and adversely affects the intrinsic safety of the network. The STI has zero inductance associated with the power supply and communications input terminals. In all applications, the inductance associated with the cables must be less than the allowable inductance (L_a) specified for the associated barriers.

All cable selections must meet the requirements as specified in the installation drawing #650591 (in this section). The power supply cable must be 24 AWG (American Wire Gauge) or heavier, shielded twisted pair with a capacitance of 50 picofarads per foot or less. The communication cable must be 24 AWG or heavier pair with a capacitance of 24 picofarads per foot or less.

MTS PROPRIETARY INFORMATION
 THE INFORMATION AND DESIGN(S) DISCLOSED HEREIN ARE THE
 PROPERTY OF MTS SYSTEMS CORPORATION AND MAY NOT BE USED,
 REPRODUCED OR DISCLOSED IN ANY FORM EXCEPT AS GRANTED
 IN WRITING BY MTS SYSTEMS CORPORATION. THIS RESTRICTION
 EXCLUDES INFORMATION THAT IS IN THE PUBLIC DOMAIN OR WAS
 LEGITIMATELY IN PRIOR POSSESSION OF RECIPIENT.

FMRC APPROVED SAFETY BARRIERS FOR DDA/STI POWER
 SUPPLY CIRCUIT INCLUDE:

- A. STAHL TYPE 8901/31-280/165/80 Cext (max)=0.30uF
 Lext (max)=5.1mH
- B. MTL TYPE 728+
 Cext (max)=0.13uF Lext (max)=4.2mH
- C. PEPPERL & FUCHS TYPE Z428/EX Cext (max)=0.42uF
 Lext (max)=15.0mH
- D. STAHL TYPE 9001/01-280-165-10 Cext (max)=0.43uF
 Lext (max)=5.4mH
- E. CROUSE HINDS TYPE SB19140M2410 Cext (max)=0.43uF
 Lext (max)=6.96mH
- F. CROUSE HINDS TYPE SB49140M2410 Cext (max)=0.43uF
 Lext (max)=6.96mH (DUAL CHANNEL TYPE)

FMRC APPROVED SAFETY BARRIERS FOR STI BACKLIGHT CIRCUIT
 INCLUDE:

- A. STAHL TYPE 8901/31-280/085/00 Cext (max)=0.33uF
 Lext (max)=14.1mH
- B. MTL TYPE 728+
 Cext (max)=0.13uF Lext (max)=4.2mH
- C. PEPPERL & FUCHS TYPE Z428/EX Cext (max)=0.42uF
 Lext (max)=15.0mH
- D. STAHL TYPE 9001/01-280-085-10 Cext (max)=0.43uF
 Lext (max)=19.3mH
- E. CROUSE HINDS TYPE SB19140M0728 Cext (max)=0.43uF
 Lext (max)=17.28mH

FMRC APPROVED SAFETY BARRIERS FOR DDA/STI COMMUNICATIONS
 CIRCUIT INCLUDE:

- A. STAHL TYPE 8901/31-086/150/70 Cext (max)=10.8uF
 Lext (max)=4.2mH
- B. MTL TYPE 710+
 Cext (max)=3.0uF Lext (max)=0.95mH
- C. PEPPERL & FUCHS TYPE Z111/EX Cext (max)=8.4uF
 Lext (max)=1.2mH
- D. STAHL TYPE 9001/01-086-150-10 Cext (max)=17.6uF
 Lext (max)=6.7mH
- E. CROUSE HINDS TYPE SB19140M0710 CEXT (max)=3.0uF
 Lext (max)=0.95mH
- F. CROUSE HINDS TYPE SB49130M0601 CEXT (max)=4.2uF
 Lext (max)=3.0mH (DUAL CHANNEL TYPE)

DRAWN	DATE
R.BARR	12-21-93
DOCUMENT OWNER	
K.PETERSON	
PRODUCT LINE	
DDA	
SCALE	DRAWING SIZE
1:1	B
SHEET	OF
3	3

MTS	
SYSTEMS CORPORATION SENSORS DIVISION <small>RESEARCH TRIANGLE PARK, NORTH CAROLINA 27709</small>	
TITLE	FMRC WIRING DIAGRAM INTRINSICALLY SAFE DDA/STI LIQUID LEVEL
DWG NO.	650591
REV	C

FMRC CONTROLLED DRAWING. NO CHANGES WITHOUT PRIOR FMRC APPROVAL
STI/DDA GAUGE NETWORK CONFIGURATION

CLASS I, II, III, DIVISION 1,
GROUPS C,D,E,F,G HAZARDOUS AREA

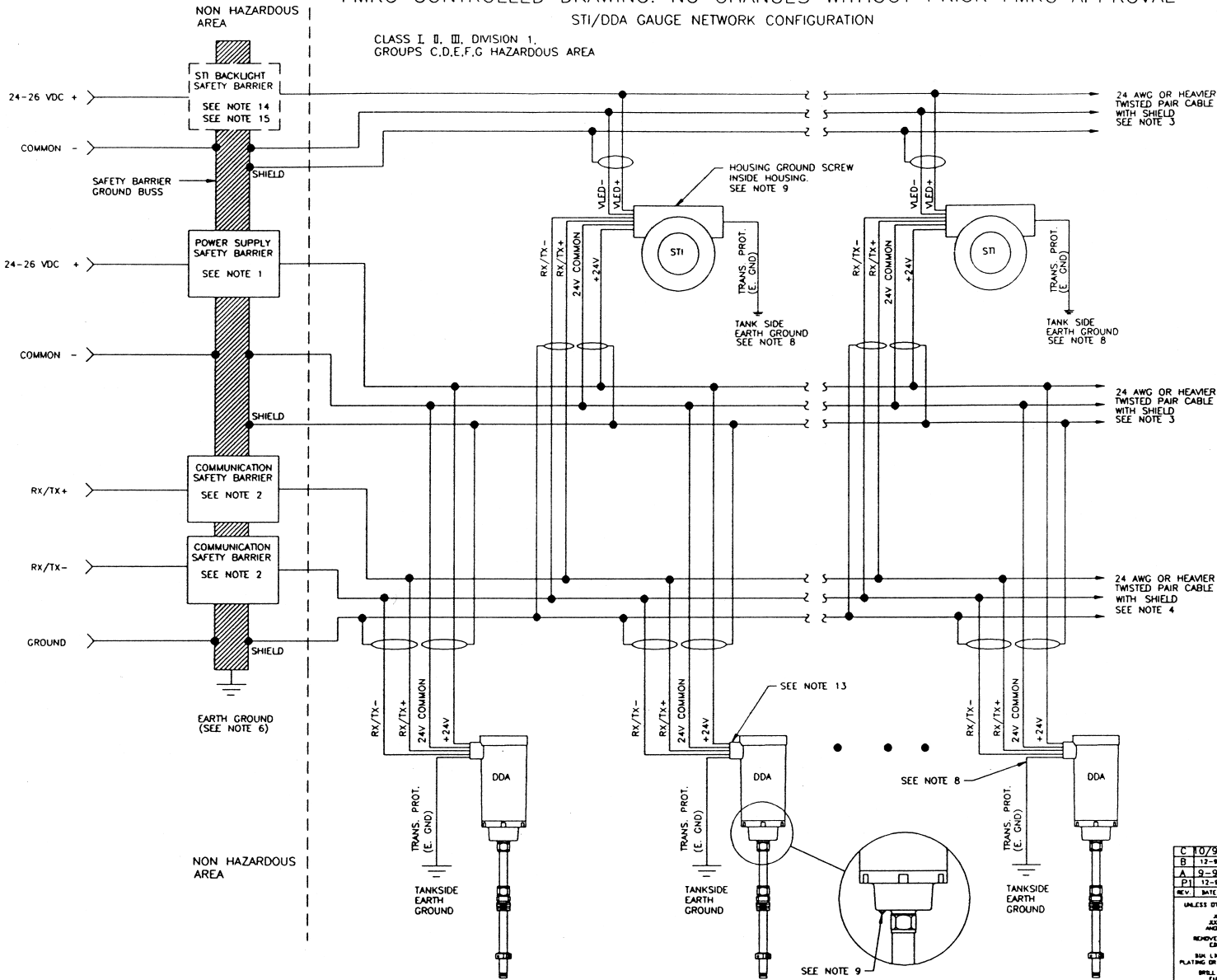

NOTES:

- SEE PAGE 3 OF THIS DRAWING FOR FMRC APPROVED LIST OF SAFETY BARRIERS FOR THE DDA/STI POWER SUPPLY CIRCUIT.
- SEE PAGE 3 OF THIS DRAWING FOR FMRC APPROVED LIST OF SAFETY BARRIERS FOR THE DDA/STI COMMUNICATIONS CIRCUIT.
- POWER SUPPLY CABLE AND STI BACKLIGHT CIRCUIT CABLE MUST BE 24 AWG OR HEAVIER, SHIELDED TWISTED PAIR CABLE. CABLE CAPACITANCE MUST BE LESS THAN 50 pF PER FOOT. CABLE TYPE AND LENGTH MUST BE SELECTED TO MEET MAXIMUM ALLOWABLE CAPACITANCE AND INDUCTANCE VALUES FOR SELECTED SAFETY BARRIER. SEE NOTE 5. CABLE SHIELD IS CONNECTED TO SYSTEM GROUND AT SAFETY BARRIER END ONLY. SEE DDA AND STI INSTALLATION MANUALS FOR ADDITIONAL CABLE INFORMATION.
- COMMUNICATIONS CABLE MUST BE 24 AWG OR HEAVIER, SHIELDED TWISTED PAIR CABLE. CABLE CAPACITANCE MUST BE LESS THAN 24 pF PER FOOT. CABLE TYPE AND LENGTH MUST BE SELECTED TO MEET MAXIMUM ALLOWABLE CAPACITANCE AND INDUCTANCE VALUES FOR SELECTED SAFETY BARRIERS. SEE NOTE 5. CABLE SHIELD IS CONNECTED TO SYSTEM GROUND AT SAFETY BARRIER END ONLY. SEE DDA AND STI INSTALLATION MANUALS FOR ADDITIONAL CABLE INFORMATION.
- THE INPUT CAPACITANCE OF EACH DDA GAUGE AND STI MODULE CONNECTION MUST BE INCLUDED IN THE TOTAL CAPACITANCE CONNECTED TO EACH SAFETY BARRIER. FOR THE 24 VOLT POWER SUPPLY CONNECTION AND THE BACKLIGHT CONNECTION C INPUT = 1600 PICO FARADS (PER DDA GAUGE OR STI MODULE). FOR THE RX/TX COMMUNICATION CONNECTION, C INPUT = 4000 PICO FARADS (PER DDA GAUGE OR STI MODULE).
FOR ALL INSTALLATIONS: $C_{a(barrier)} \geq C_{cable} + C_{gauges} + C_{sti's}$.
THE INPUT INDUCTANCE OF EACH DDA GAUGE OR STI MODULE = 0.
FOR ALL INSTALLATIONS: $L_{a(barrier)} \geq L_{cable}$.
- THE WIRE CONNECTION BETWEEN EARTH GROUND AND THE SAFETY BARRIER GROUND BUSS MUST BE LESS THAN 1 OHM.
- MAXIMUM APPROVED NUMBER OF DDA GAUGES AND STI MODULES FOR INTRINSICALLY SAFE WIRING NETWORKS IS 32. SEE OPERATION AND INSTALLATION MANUALS FOR SYSTEM CONFIGURATIONS AND RESTRICTIONS.
- CONNECTION TO EARTH GROUND FOR TRANSIENT PROTECTION CIRCUITRY.
- GROUND SCREW PROVIDED TO CONNECT HOUSING TO EARTH GROUND.
- ELECTRONIC EQUIPMENT CONNECTED TO ASSOCIATED APPARATUS MUST NOT USE OR GENERATE MORE THAN 250 VOLTS RMS.
- CABLE SETS THAT ARE RUN TOGETHER MUST HAVE SUFFICIENT INSULATION TO WITHSTAND 250 VOLTS RMS BETWEEN SETS.
- ALL WIRING MUST MEET THE REQUIREMENTS OF THE NEC AND LOCAL CODES.
- DUST TIGHT SEAL AT CONDUIT ENTRY REQUIRED IN CLASS II OR CLASS III LOCATIONS.
- STI BACKLIGHT CIRCUIT CONNECTION IS OPTIONAL.
- SEE PAGE 3 OF THIS DRAWING FOR FMRC APPROVED LIST OF SAFETY BARRIERS FOR THE STI BACKLIGHT CIRCUIT.

NO REVISIONS SHALL BE MADE WITHOUT NOTIFICATION TO APPROVAL AGENCY(S)

C 10/95	RB	NOV	ADDED PAGE 3 AND SHIELDING TO DRAWING
B 12-84	RB	2824	ADDED 2 MORE WTL BARRIERS
A 9-94	RB	2680	RELEASE TO PRODUCTION
P1 12-83	RB		NEW DRAWING

REV	DATE	BY	DESCRIPTION

UNLESS OTHERWISE SPECIFIED: ALL DIMENSIONS ARE IN INCHES DIMENSIONS IN PARENTHESES ARE IN MILLIMETERS	MATERIAL	DESIGNER R. BARR	DATE 12-21-83
REMOVE BURRS AND SWAMP CRACKS AND FINISH SILK FINISH NEAR WELDS PLATING OR CONVERSION COATING DRILL REPTHS ARE TO FULL DEPTH TAP REPTHS ARE HORIZONTAL FULL THREAD	FINISH	DATE 12-21-83	DATE
DO NOT SCALE DRAWING	SCALE	TITLE FMRC WIRING DIAGRAM INTRINSICALLY SAFE DDA/STI LIQUID LEVEL	
		SHEET 1 OF 3	DWG NO. 650591

FMRC CONTROLLED DRAWING. NO CHANGES WITHOUT PRIOR FMRC APPROVAL STI/DDA GAUGE STAND ALONE CONFIGURATION

CLASS I, II, III, DIVISION 1,
GROUPS C,D,E,F,G HAZARDOUS AREA

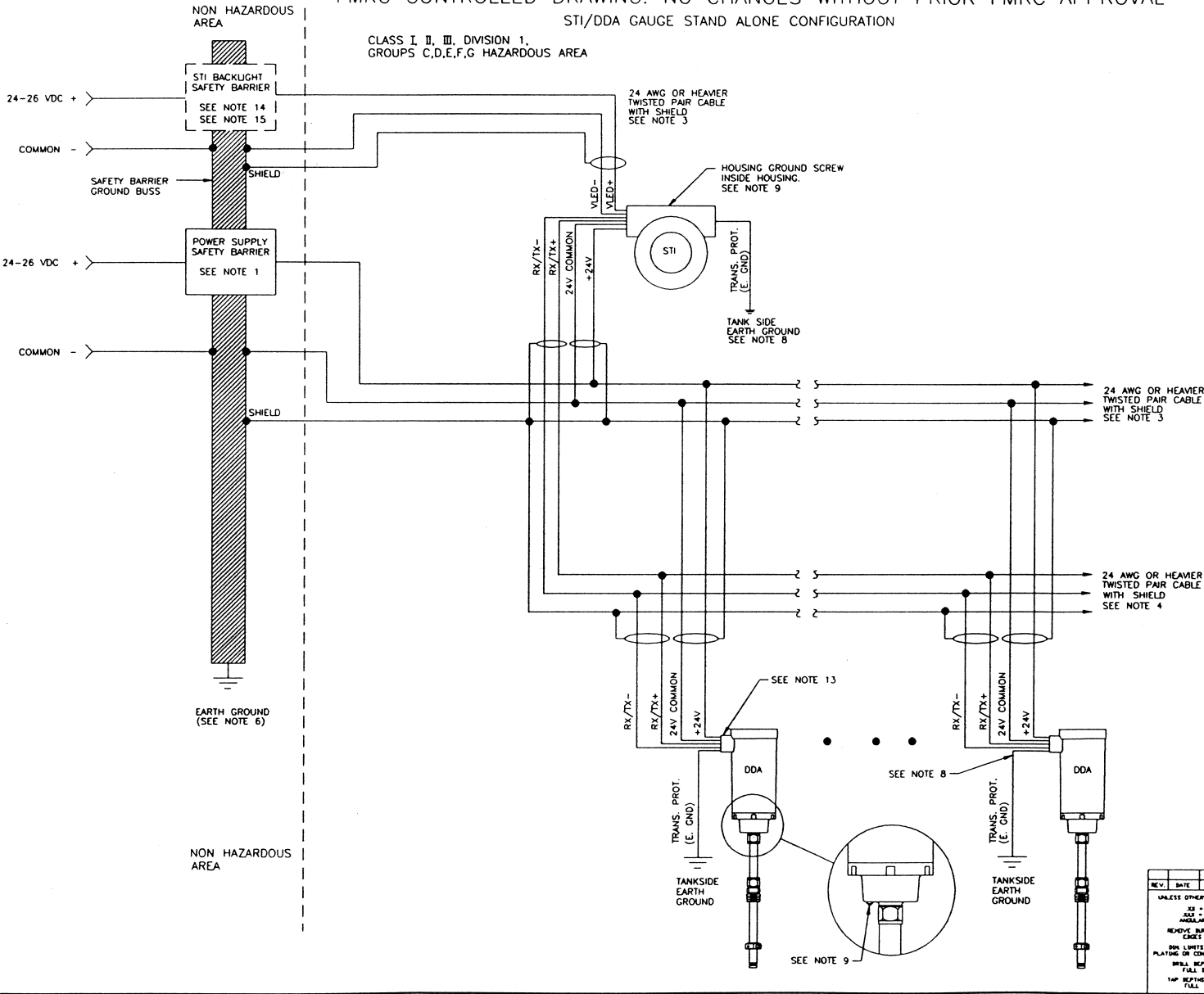

NO REVISIONS SHALL BE MADE WITHOUT NOTIFICATION TO APPROVAL AGENCY(S)

REV.	DATE	BY	REV. NO.	DESCRIPTION
				UNLESS OTHERWISE SPECIFIED: SUS - 304 FINISH - 304 ANGLE - 90°
				RECEIVE BURS AND SHARP EDGES, 60° FINISH
				DRILL UNITS HELD AFTER PLATING OR CONVERSION COATING
				DRILL DEPTH TO FULL DIAMETER
				TAP DEPTH AND HOLEMAN FULL THREAD
				DO NOT SCALE DRAWING
				SCALE ---
				SHEET 2 OF 3
				REV. C

<p style="text-align: center;">SENSORS DIVISION</p> <p style="text-align: center;">RESEARCH VEHICLE PANEL HEATH CABLE BOX 87799</p> <p style="text-align: center;">TITLE FMRC WIRING DIAGRAM INTRINSICALLY SAFE DDA/STI LIQUID LEVEL</p>	<p>PWG NO 650591</p>
---	--------------------------

Since the resistance of the cable is the dominant factor in determining the maximum cable length of the network, heavier gauge cables will allow longer cable runs. This is true because heavier gauge cables have lower resistance ratings per foot. For example, the resistance of a typical 22 AWG cable is 15 ohms per 1000 feet of cable where as 18 AWG cable is 6 ohms per 1000 feet of cable. The power supply cable and the communications cable selected should be same size (AWG). See Section 2.3 in this manual for recommended cable types.

The barrier type also affects the maximum length of the cable. This is because each barrier has a different series resistance. A DDA/STI network that uses safety barriers with higher series resistance will consequently have shorter maximum cable lengths and will handle fewer devices on the network. Safety barrier selection is determined by the power supply circuit only. The resistance of the communications circuit safety barrier is not critical and does not need to be considered when determining cable type or maximum cable runs.

The cable selection graphs are based on the resistance factors of the DDA/STI network and do not account for capacitance and inductance aspects. In many cases, maximum cable length may be limited by the total capacitance or total inductance of the network so that the intrinsic safety of the network is maintained. As previously mentioned, the capacitance and inductance of the network taps must be considered in the total capacitance of the network.

In summary, to maintain the intrinsic safety of the DDA/STI network:

For the power supply circuit (and optional backlight circuit):

$C_a(\text{barrier}) > C(\text{cable}) + C(\text{displays}) + C(\text{gauges})$

1. $C(\text{gauge})$ or $C(\text{displays}) = 1600$ picofarads per device
2. $L_a(\text{barrier}) > L(\text{cable})$

For the communications circuit:

$C_a(\text{barrier}) > C(\text{cable}) + C(\text{displays}) + C(\text{gauges})$

1. $C(\text{gauge})$ or $C(\text{displays}) = 4000$ picofarads per device
2. $L_a(\text{barrier}) > L(\text{cable})$

The cable selection graphs (figures 2.4, 2.5, and 2.6) indicate possible cable lengths up to 8000 feet in certain applications. Cable lengths of this maximum distance can only be achieved

if both the cable selection (for the communications circuit) and the communications driver chip (from the host interface) meet the requirements as defined by the EIA-485 standard. The EIA-485 standard states that cable for the communications circuit must have a nominal impedance of 120 ohms and be of the low capacitance type (less than 20 picofarads per foot). In addition, any communications driver chip on the network must be able to drive 32 loads. The EIA-485 standard does not apply to the cable selection for the power supply.

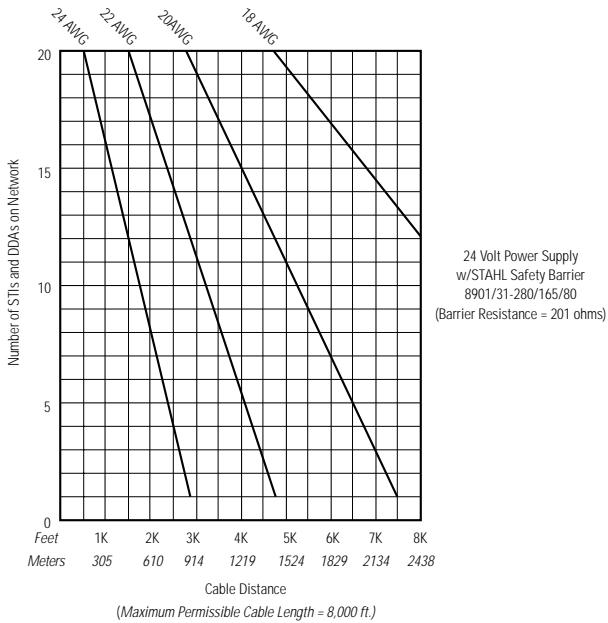
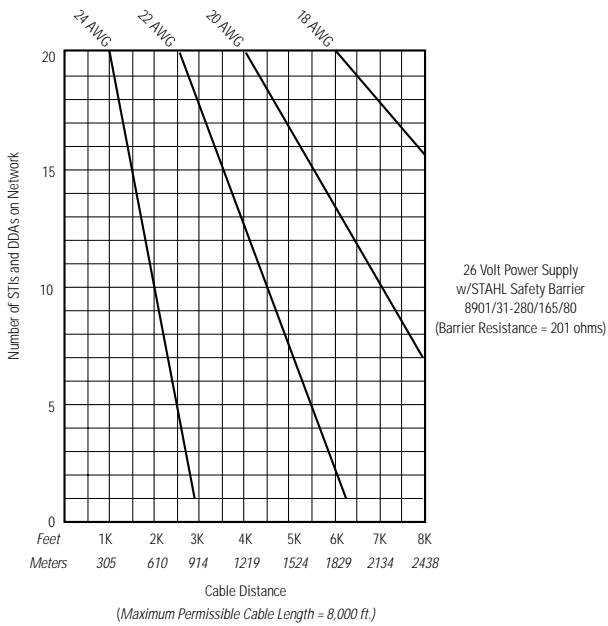

Figure 2.4 Cable Selection (using STAHL Safety Barriers)

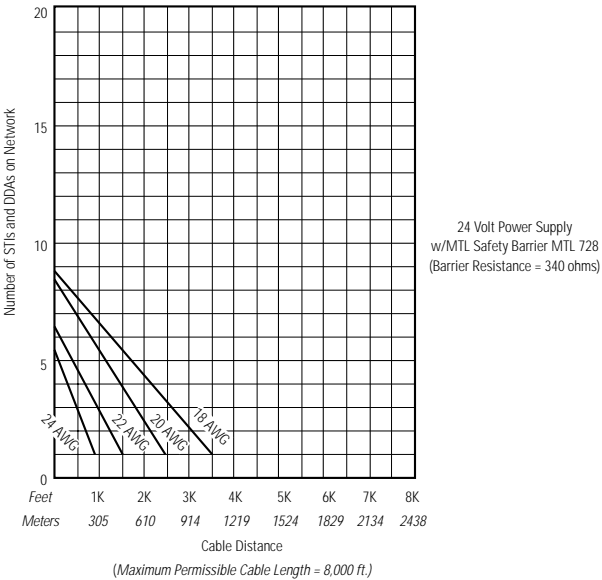
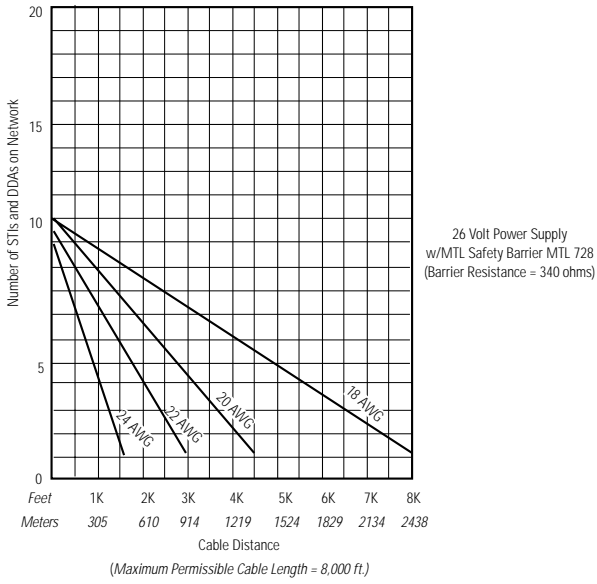

Figure 2.5 Cable Selection (using MTL Safety Barriers)

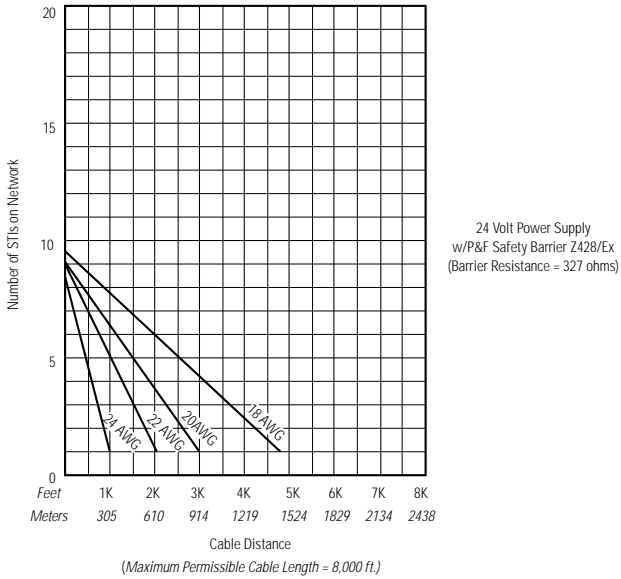
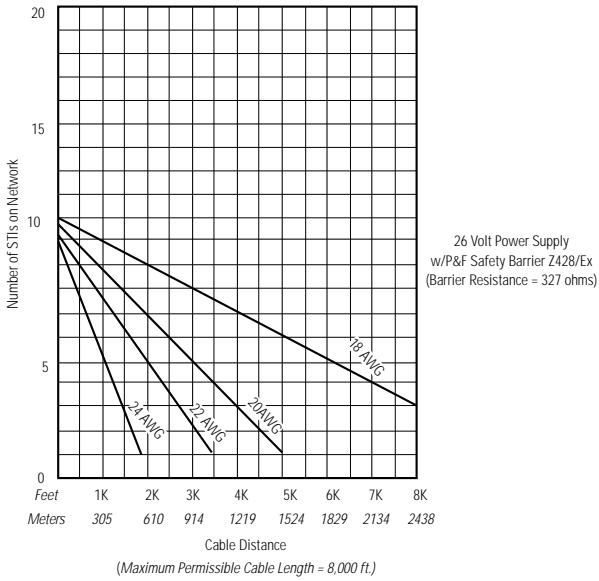

Figure 2.6 Cable Selection (using P&F Safety Barriers)

2.3 Recommended Cable Types

This section lists recommended cable types for the STI power supply, communications, and back light (optional) circuits. The following lists do not include all possible cable types and manufacturers. The lists should be used only as a guideline when choosing cables. Cables from other manufacturers may be used as long as they meet the general requirements as identified.

Recommended Single Pair Cable Types - Power Supply Circuit (and optional Backlight Circuit)

General Cable Requirements:

- Shielded twisted pair
- 50 picofarads per foot or less. See note below
- Insulation thickness: 0.10 in. (0.25 mm) minimum

NOTE:

For the power supply circuit, the return conductor is connected to the shield at the safety barrier ground terminal.

When determining the capacitance of cable for the power supply circuit, use the manufacturer's capacitance specifications shown for 1 conductor and the other conductor connected to the shield.

Wire Size (AWG)	Capacitance (Pf/foot)	Manufacturer	Cable #	NOTES
16	40	ALPHA	2471	(16 AWG ok)
18	44	BELDEN	8760	
18	49	BELDEN	9460	
16	49	CAROL	C2536	(16 AWG ok)
18	44	CAROL	C2521	
18	43	DEKORON	1T52-8820T	
20	49	BELDEN	8762	
20	49	BELDEN	9464	
20	40	CAROL	C2519	
20	45	CAROL	C2520	
20	46	MANHATTAN	M39047	
20	42	DEKORON	1T52-0810T	
22	16	ALPHA	6072	(extra wire pair)
22	47	BELDEN	8761	
22	47	BELDEN	9461	
22	36	CAROL	C2518	
22	47	CAROL	C2514	
22	38	DEKORON	1T52-2810T	(0.020" insulation)
24	23	BELDEN	9841	
24	42	BELDEN	8641	
24	42	CAROL	C2513	
24	40	DEKORON	1T52-A800T	

Recommended Single Pair Cable Types - Communications Circuit

General requirements:

- Shielded twisted pair
- 24 picofarads per foot or less. See note below
- Nominal impedance range - 100 to 150 ohms
- Insulation thickness: 0.10 in. (0.25 mm) minimum

NOTE:
For the communications circuit, the shield is terminated independently at the safety barrier ground terminal. When determining the cable capacitance for the communications circuit, use the manufacturer's capacitance specifications shown for conductor to conductor.

Wire size (AWG)	Capacitance (Pf/foot)	Manufacturer	Cable #	Notes
16	21	ALPHA	2471	(16 AWG ok)
18	24	BELDEN	8760	
18	16	BELDEN	9450	(twin axial)
16	11	CAROL	C8013	(16 AWG ok, twin axial)
18	24	CAROL	C2521	
18	24	DEKORON	1T52-8820T	
20	22	BELDEN	83393	
20	16	BELDEN	9207	(twin axial)
20	22	CAROL	C2519	
20	16	CAROL	C8010	(twin axial)
20	16	MANHATTAN	M4270	(twin axial)
20	23	DEKORON	T52-0810T	
22	9	ALPHA	6072	(extra wire pair)
22	22	BELDEN	83394	
22	20	BELDEN	9999	(twin axial)
22	20	CAROL	C2518	
22	9	CAROL	C8014	(twin axial)
22	9	MANHATTAN	M39240	
22	21	DEKORON	1T52-2810T	(.020" insulation)
24	13	BELDEN	9841	
24	22	BELDEN	8641	
24	3	CAROL	C2513	
24	22	DEKORON	1T52-A800T	

Recommended Multiple Pair Cable Types - Power Supply, optional Backlight Circuit & Communication Circuits

NOTE:

Requires 3 pair cable if using optional backlight circuit.

General Requirements:

- Individually shielded, twisted pair, 2 or 3 pairs
- 24 picofarads per foot or less. See note below
- Insulation thickness: 0.10 in. (0.25 mm) minimum

NOTE:

The capacitance figures in this chart include information for both communications and power supply circuits. The value on the left applies to the communications circuit. The value on the right applies to the power supply circuit where the capacitance of the cable is measured from one conductor and the other conductor connected to the shield.

Wire Size (AWG)	Capacitance (Pf/foot)	Manufacturer	Cable #	NOTES
18	24/43	DEKORON	1T74-80222	2 wire pairs
20	22/44	ALPHA	2467C	4 wire pairs
20	3/44	DEKORON	1T74-00212	2 wire pairs
22	9/17	BELDEN	9688	2 wire pairs
22	16/28	MANHATTAN	M3490	2 wire pairs
22	21/38	DEKORON	1T74-20212	2 wire pairs
24	13/22	ALPHA	6073	3 wire pairs
24	13/22	BELDEN	8162	2 wire pairs
24	13/23	BELDEN	9729	2 wire pairs
24	13/23	CAROL	C0924	2 wire pairs
24	13/23	MANHATTAN	M39249	2 wire pairs
24	13/22	MANHATTAN	M3475	2 wire pairs
24	22/40	DEKORON	1T74-A0202	2 wire pairs

NOTE:

Most cable manufactures do not list inductance properties for cables. Where the inductance properties are unavailable, ISA RP12.6 (Installation of Intrinsically Safe Instrument Systems in Class Hazardous Locations) recommends the use of 0.2uH (micro henries) per foot as a value for cable inductance.

2.4 How To Select Cables

The steps and criteria used for selecting cables for an intrinsically safe DDA/STI network are outlined below.

1. Determine the number of devices that will be connected to the network. The maximum number of devices (i.e., DDA tank gauges, and STI displays) is limited to 20 on an intrinsically safe network.
2. Determine the type (brand) of safety barrier that will be used for the power supply circuit. Currently three types of barriers are approved for a DDA/STI network, they are:
 - A. Stahl 8901/31 - 280/165/80 [max. resistance (end-to-end) = 201 Ω]
 - B. MTL 728 [max. resistance (end-to-end) = 340 Ω]
 - C. Pepperl & Fuchs Z428/EX [max. resistance (end-to-end) = 327 Ω]

As stated earlier, the safety barrier with the lowest end-to-end resistance will allow more devices to operate on the network and/or the longest cable lengths. This can be verified by reviewing the cable selection charts for each type of barrier. Safety barrier types (brands) should not be mixed for the power supply circuit and communications circuit. If STAHL is selected for the power supply circuit, then STAHL should be used for the communications circuit. See the installation drawing (MTS drawing number 650591) presented in this manual for safety barrier types usable with the communications circuit.

3. Determine the power supply voltage that will be used for the devices on the network. The available choices are limited to 24 volts and 26 volts (DC). As indicated by the cable selection graphs, the larger the power supply voltage will allow more devices on the network and/or longer cable lengths. See section 2.6 of this manual for additional information about power supplies for the network.
4. Determine the maximum proposed cable length that will be required for the network trunk for the particular application. Tap connections between the main network trunk and each DDA or STI display is limited to 200 feet. Absolute maximum trunk length is limited to 8000 feet.
5. Using the respective cable selection chart for the safety barrier type and power supply voltage selected above, determine the cable wire gauge (AWG size) required for the number of gauges and cable length information determined above.

NOTE:

If a suitable cable gauge cannot be found in charts, then the number of DDA gauges and STI displays must be reduced. The safety barrier type or the power supply voltage may also be changed depending on the particular situation.

6. Select cables from the recommended cable lists (or other source) that meet the gauge and capacitance specifications for the power supply circuit and the communications circuit. The cable capacitance specifications are shown in the MTS installation drawing # 650591, in section 2.2 of this manual. The general specifications are 50 picofarads or less for the power supply and backlight circuits and 24 picofarads or less for the communications circuit.

7. Calculate the maximum network capacitance for each circuit (power supply, optional backlight, and communications). Include the capacitance of the cable and the capacitance of each device on the network. The capacitance of each network tap connection must also be included in the total cable capacitance. Verify that the following equations are met to insure the intrinsic safety of the system:

For the power supply circuit (and optional backlight circuit):

$$C_a(\text{barrier}) > C(\text{cable}) + C(\text{devices})$$

$C(\text{devices}) = 1600$ picofarads per DDA tank gauge or STI display

For the communications circuit:

$$C_a(\text{barrier}) > C(\text{cable}) + C(\text{devices})$$

$C(\text{devices}) = 4000$ picofarads per DDA tank gauge or STI display

NOTE:

If the above equations cannot be met, then the cable length must be reduced or another cable type used. Alternatively, the number of tank gauges or STI displays can be reduced.

8. Calculate the maximum network inductance for each circuit (power supply, optional backlight, and communications), include only the inductance of the cable. The inductance of each network tap connection must also be included in the total cable inductance. The inductance of each DDA tank gauge or STI display is zero. Verify that the following equations are met to insure the intrinsic safety of the system:

For the power supply circuit (and optional backlight circuit):

$$L_a(\text{barrier}) > L(\text{cable})$$

For the communications circuit:

$$L_a(\text{barrier}) > L(\text{cable})$$

9. Document all calculations for future reference.

EXAMPLE CABLE SELECTION

Assumptions:

- 10 DDA tank gauges and 10 STI displays on network
- 2000 ft. cable length
- 20 network tap connections at 50 feet each (1000 ft. total)
- 24 Vdc power supply

STEP 1. Determine the maximum number of devices (DDA tank gauges and STI displays) connected to the network. Per the assumptions listed above, the desired maximum number of devices is twenty.

STEP 2. Identify the type of safety barriers that will be used in the network. For networks that include more than 5 devices or have long cable runs, the safety barrier with the lowest end-to-end resistance must be chosen. For this application, the STAHL barriers are selected.

For the power supply circuit (and optional backlight circuit):
STAHL type 8901/31-280/165/80 will be used.

For the communications circuit:
STAHL type 8901/32-093/135/70 will be used

(per MTS installation drawing # 650591).

STEP 3. Determine the power supply voltage that will be used for the network. Per the assumptions listed above, a power supply voltage of 24 Vdc is chosen. See section 2.4 of this manual for more information about power supply requirements.

STEP 4. Determine the maximum cable length required for the network trunk. Per the assumptions listed above, the desired maximum cable length of 2000 feet.

Based on a power supply voltage of 24 Vdc and STAHL type safety barriers and the cable selection graph (see figure 2.7). Entering the graph from the horizontal axis at 2000 feet and from the vertical axis at 20 devices gives an intersection point as shown below. Only cables shown to the right of the intersection point can be used. From the graph, cables of 20 AWG or heavier can be used.

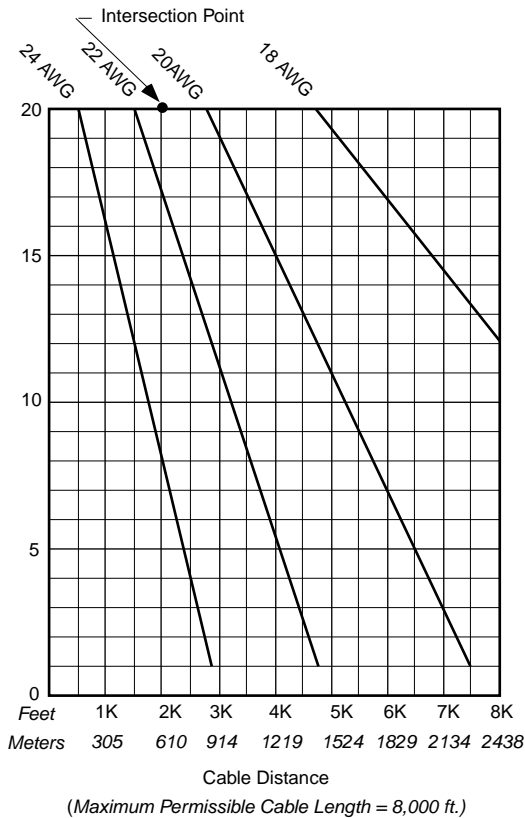

24 Volt Power Supply
w/ STAHL Safety Barrier
8901/31-280/165/80
(Barrier Resistance = 201 ohms)

Figure 2.7 Cable Selection

NOTE:

If a cable selection cannot be found to the right of the intersection point, then the number of devices or the length of the cable must be reduced to move the intersection point down or to the left, respectively. Alternatively, the power supply voltage can be increased to 26 volts (DC).

STEP 5. Select cables from the recommended cable list that meet the capacitance specifications for the power supply circuit, optional backlight circuit, and the communications circuit.

For the power supply circuit and backlight circuit, the cable capacitance must be 50 picofarads per foot or less. Assuming 20 AWG wire size, the cable lists show six cable selections with a capacitance of 50 picofarads or less. The six suggested types are shown below.

Wire Size (AWG)	Capacitance (Pf/foot)	Manufacturer	Cable #
20	49	BELDEN	8762
20	49	BELDEN	9464
20	40	CAROL	C2519
20	45	CAROL	C2520
20	46	MANHATTAN	M39047
20	42	DEKORON	1T52-0810T

The Belden 8762 will be chosen for this example.

For the communications circuit, the cable capacitance must be 24 picofarads per foot or less. Assuming 20 AWG wire size, the cable lists show six cable selections with a capacitance of 24 picofarads or less. The six suggested types are shown below.

Wire Size (AWG)	Capacitance (pf/foot)	Manufacturer	Cable #
20	22	BELDEN	83393
20	16	BELDEN	9207
20	22	CAROL	C2519
20	16	CAROL	C8010
20	16	MANHATTAN	M4270
20	23	DEKORON	1T52-0810T

The Belden 83393 will be chosen for this example.

STEP 6. Calculate the maximum network capacitance for each circuit (power supply, backlight, and communications).

For the power supply circuit (and optional backlight circuit):

$$C_a(\text{barrier}) > C(\text{cable}) + C(\text{devices})$$

$$C(\text{device}) = 1600 \text{ picofarads per DDA tank gauge or STI display}$$

For the communications circuit:

$$C_a(\text{barrier}) > C(\text{cable}) + C(\text{devices})$$

$$C(\text{device}) = 4000 \text{ picofarads per DDA tank gauge or STI display}$$

Per the assumptions listed above:

A. 2000 feet of cable for the main trunk

B. 1000 feet of cable for all network tap connections (total)

C. 20 devices on the network

$$D. C_a(\text{carrier}) \text{ STAHL } 8901/31-280/165/80 = 0.3\mu\text{F}$$

$$E. C_a(\text{barrier}) \text{ STAHL } 8901/32-093/135/70 = 7.8\mu\text{F}$$

For the power supply circuit using BELDEN 8762 cable

$$C(\text{cable}) = (3000 \text{ ft.}) * (49 \text{ pF/ft.}) = 147,000 \text{ pF} = 0.147 \mu\text{F}$$

$$C(\text{gauges}) = (20) * (1600 \text{ pF/device}) = 32,000 \text{ pF} = 0.032\mu\text{F}$$

$$C(\text{total}) = 0.147\mu\text{F} + 0.032 \mu\text{F} = 0.179 \mu\text{F}$$

Since the power supply circuit capacitance $0.179 \mu\text{F}$ is less than the maximum allowed for the STAHL power supply circuit barrier ($0.3\mu\text{F}$), the power supply circuit meets intrinsic safety requirements with respect to capacitance.

For the communications circuit using BELDEN 83393 cable

$$C(\text{cable}) = (3000 \text{ ft.}) * (22 \text{ pF/ft.}) = 66,000 \text{ pF} = 0.066 \mu\text{F}$$

$$C(\text{gauges}) = (20) * (4000 \text{ pF/device}) = 80,000 \text{ pF} = 0.080 \mu\text{F}$$

$$C(\text{total}) = 0.066\mu\text{F} + 0.080 \mu\text{F} = 0.146 \mu\text{F}$$

Since the communication circuit capacitance of $0.146 \mu\text{F}$ is less than the maximum allowed for the STAHL communication circuit barrier ($7.8\mu\text{F}$), the communication circuit meets intrinsic safety requirements with respect to capacitance.

NOTE:

If the preceding equations cannot be met, then the cable length must be reduced or another cable type must be used. Alternatively, the number of devices can be reduced.

STEP 7. Calculate the maximum network inductance for each circuit (power supply, backlight, and communications).

For the power supply circuit (and optional backlight circuit):

$$L_{\text{a}}(\text{barrier}) > L(\text{cable})$$

For the communications circuit:

$$L_{\text{a}}(\text{barrier}) > L(\text{cable})$$

Per the assumptions listed above:

A. 2000 feet of cable for the main trunk

B. 1000 feet of cable for all network tap connections (total)

C. $L_{\text{a}}(\text{barrier})$ STAHL 8901/31-280/165/80 = 5.1 mH maximum

D. $L_{\text{a}}(\text{barrier})$ STAHL 8901/32-093/135/70 = 4.8 mH maximum

E. Use $0.2 \mu\text{H}/\text{foot}$ for cable inductance parameter per ISA RP12.6

For the power supply circuit and backlight circuit using BELDEN 8762 cable:

$$L(\text{cable}) = (3000 \text{ feet}) * (0.2 \mu\text{H}/\text{foot}) = 600 \mu\text{H} = 0.6 \text{ mH}$$

$$L(\text{devices}) = 0 \text{ mH}$$

$$L(\text{total}) = 0.6 \text{ mH}$$

Since the power supply circuit inductance of 0.6 mH is less than the maximum allowed for the STAHL power supply circuit barrier (5.1 mH), the power supply circuit and backlight circuit meets intrinsic safety requirements with respect to inductance.

For the communications circuit using BELDEN 83393 cable:

$$L(\text{cable}) = (3000 \text{ feet}) * (0.2 \text{ } \mu\text{H/foot}) = 600 \text{ } \mu\text{H} = 0.6 \text{ mH}$$

$$L(\text{devices}) = 0 \text{ mH}$$

$$L(\text{total}) = 0.6 \text{ mH}$$

Since the communications circuit inductance of 0.6 mH is less than the maximum allowed for the STAHL communications circuit barrier (4.8 mH), the communications circuit meets intrinsic safety requirements with respect to inductance.

NOTE:

If the above equations cannot be met, then the cable length must be reduced or another cable type with lower inductance specifications must be used.

STEP 8. Document all calculations for future reference.

2.5 Field Wiring Installation

Where applicable, cable installations must meet the requirements of an intrinsically safe (I.S.) system installed in hazardous locations. In addition to the capacitance and inductance of the cable (see Section 2.2), the designer and installer of an I.S. system must be aware of the field wiring requirements. Each particular application must meet both the National Electrical Codes (NEC) as well as local electrical codes covering I.S. installations. Consult the Instrumentation Society of America's (ISA) Recommended Practice RP12.6, titled "Installation of Intrinsically Safe Systems for Hazardous (Classified) Locations". Refer to Appendix A of this manual for additional publications dealing with this subject.

Below is a list of topics to be considered when planning a DDA/STI installation.

1. **Cable types** - Always use shielded, twisted pair cable; it provides excellent rejection to electrical interference. Differential communication signals (EIA-485) combined with shielded, twisted pair cable will allow the network to operate successfully in electrically noisy environments.
2. **Cable shields** - Cable shields for the power supply circuit and the communications circuit are terminated (grounded) at the safety barrier end only to the safety barrier ground bus. Do not ground shields at the device end of the cable or at any other point within the network.
3. **Cable routing** - Cable routing should be planned to minimize the total length of the network trunk. Excessive trunk length may limit the number of gauges that can be installed on a network. Refer to Section 2.3 of this manual for more information on maximum cable length and number of devices allowed on the network. Always route cables to avoid sources of electrical interference. Electrical noise sources to avoid include commutating motors, electrical welders, switched inductive loads, switched AC mains and other sources that generate electrical interference. Always route network cables in cable trays making sure to separate them from cables that control or power the above mentioned noise sources. Always route I.S. wiring away from non-I.S. wiring.

4. **Cable splices** - All cable splices within the network wiring should be protected by seals and/or terminal boxes. All connectors or terminal hardware should be of non-corrosive type and attached to the wires using crimp or crimp and solder (preferred) techniques. Exposed connections must be insulated from other wires, junction boxes, ground, etc.
5. **System expansion** - Where possible, consider routing the main network trunk through field junction boxes where plant expansion is likely to occur. This can minimize the rewiring of the network to accommodate future module installations.
6. **Disconnect switches** - Where possible, consider using local disconnect switches for each tap connection from the main trunk. The switches can be used to power down a device that requires service, effectively removing it from the network without disrupting the operation of other devices. The disconnect switch must disconnect all of the bus connections (power, communications, and optional backlight circuit). Minimum switch ratings is 50VDC @ 100 mA. Installed disconnect switches must meet the requirements of applicable electrical codes.
7. **Cable polarity** - Both the power supply circuit and the communication circuits are polarized. Use color codes to identify the different circuits and document the colors used to assist in future maintenance. The STI is protected in the event of polarity reversal, but the system will fail to operate if circuit polarity is reversed.
8. **Documentation** - Document all aspects of the network installation. Include such items as cable routing map, tap locations and lengths, number of devices (both DDA gauges and STI displays), device addresses, cable capacitance and inductance calculations, locations of splices and junction boxes, cable types, color codes, etc. This information will help in analyzing and correcting problems during system start up and future maintenance of the system.

If not already removed, remove the electronics module from the STI enclosure. Place it in a safe place such as the shipping carton that the STI was received in. Refer to MTS drawing #650597 in this section for a detailed view of the P1/P2 terminal block. This drawing shows a typical installation of an STI display with an MTS Level Plus Monitor being used as the host. To connect the field wiring to the terminal block, you will need a small, flat blade screwdriver.

Observe the following procedures and precautions.

1. Use a maximum wire gauge of 18 AWG to make connections to the terminal block. A maximum of two conductors per terminal are allowed.
2. Use stranded wire for flexibility.
3. After stripping the wire and before inserting them into the terminals, twist strands together and tin them with a soldering iron if possible. Do not attach cable shields to the STI. All shield wires should be terminated at the safety barrier.
4. Use needle nose pliers to help guide wires into position when necessary. Connect each conductor to the appropriate termination point using a small flat blade screwdriver. Do not over tighten the terminal block screws! Be sure to observe polarity for each circuit. If your conduit system is earth grounded, make a connection from the earth ground connection on P1 to the ground screw provided at the top of the enclosure. Otherwise, earth ground should be connected to another local ground.
5. After making each connection, make sure the wire is properly connected and that no stray wire strands are shorting between terminals.
6. Before making electrical connections, you may find it necessary to perform the cable tests described in Sections 4.1 and 4.2 (test method 1) of this manual. After you are confident that the cable is correct, you should make electrical connections to the P1/P2 terminal block (see MTS drawing #650597 in this section). Next, re-install the electronics module. If you have not already done so, now would be a good time to make switch adjustments (see section 2.7). After completion, re-install the enclosure cover and tighten for proper seal.

2.6 Power Supply Requirements

The power supply voltage regulation for a DDA/STI system is not critical since each DDA/STI incorporates on board regulation. Both the DDA and STI are designed to tolerate changing voltage levels at the power supply terminals which result from changing load conditions which result in voltage drops across the safety barriers. The power supply selected must supply the rated current for all networks connected to it. The maximum rated current for a single network is 100 mA. For example, if three networks were powered by one supply, it must be able to supply 300 mA. The use of individual power supplies is recommended to prevent complete system shut-down in case of a power supply failure.

If the STI is being used in Stand-alone mode, a single 100 mA current supply is adequate to power the STI display as well as up to eight DDA tank gauges. If the STI is being added to an existing network, the existing supply should be re-evaluated to be sure it is capable of handling the additional load. In most cases this will not present a problem since an STI display operating in network mode only requires an additional 1.5 milliamps. For information on the power requirements of the DDA tank gauge, refer to the DDA gauge manual (P/N 550164). If the STI optional back light circuit is being used, an additional 50 mA current demand is required from the power supply when the back light is on.

Power Supply Specifications for 24 Volt or 26 Volt System:

Output Voltage (at rated load): 24 Volts or 26 Volts (DC) \pm 0.5%
Output Current: 100 milliamps (per network)
Load Regulation: 0.5% maximum
Line Regulation: 0.5% maximum
Output Ripple: 100 millivolts, maximum

2.7 Switch Settings

The STI has three switches. To access these switches, first remove the cover from the enclosure by rotating it counter clockwise. The three switches are located on the display PCB at the top of the assembly. The face plate has a cut-out area to allow access to these switches. Use a small flat blade screwdriver to adjust the DIP switches. Note that the “ON” indicator is in a different location on each switch. Also, note that “ON” does not necessarily mean a function is enabled.

WARNING:

Always observe necessary precautions when removing the STI cover in a hazardous location. Obtain any necessary permits, etc. before opening the STI enclosure.

The information in this section is provided primarily for initial setup. For more details on the actual functions of the switch settings, refer to Section 3.0 on operation.

2.7.1 Default Settings

The STI units are shipped from the factory with the default DIP switch setting shown in figure 2.8. In the default configuration, the unit is in Network mode with the power override function disabled. The Communications Time-out Timer and Data Error Detection functions are enabled. The temperature unit is set to degrees F and the level unit is decimal mode. The network address of the unit is 80 hex. If there is more than one STI being installed on a given network, be sure to set the address switches for each device to a unique address value. See the following sections 2.7.2 to 2.7.4 for more detailed information regarding the DIP switch configuration options.

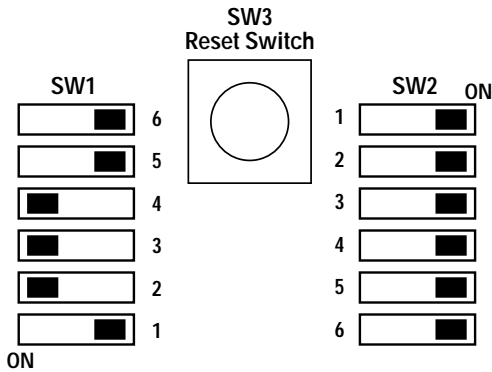

Figure 2.8 Default Switch Settings

2.7.2 DIP Switch #1 (SW1)

This switch serves the same function in both Stand-alone and Network modes. It is used to set the power override and mode of operation as well as setting the Communications Time-out Timer (CTT), Data Error Detection (DED), Temperature Units, and Level Units. Each switch function is described in detail below

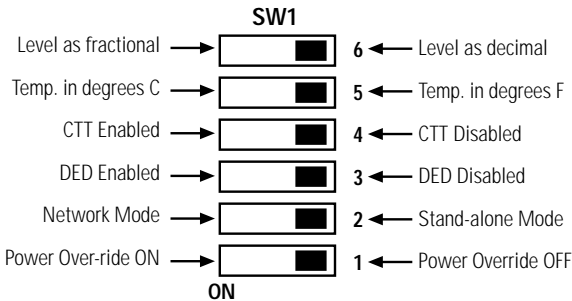

Figure 2.9 DIP Switch #1 Functions

SW1.1 - Power override: This switch controls the +5V power supply override circuit. If it is in the OFF position, the internal power supply circuitry only comes on when a valid command has been received and is being processed. When in the ON position, the supply is always on. This switch must be in the ON position when operating the STI in Stand-alone mode (and special test modes), otherwise it should normally be OFF.

SW1.2 - Mode: To operate the STI in Stand-alone mode, place this switch in the OFF position. See Section 3.1 of this manual for more details on operating the STI in Stand-alone mode. To operate the STI in Network mode, place this switch in the ON position. See Section 3.2 of this manual for more details on operating the STI in Network mode. Always press the reset switch SW3 after putting an STI in Stand-alone mode.

SW1.3 - Data Error Detection: The Data Error Detection (DED) function is available in both the Stand-alone and Network modes. When the DED switch is in the OFF position, the DED function is disabled. When the DED switch is in the ON position, the DED function is enabled. The actual DED mode is determined by the setting of the DED byte in the Firmware Control Code. See Section 3.7.1 of this manual for information on the Firmware Control Code.

SW1.4 - Communications Time-out Timer: The Communications Time-out Timer (CTT) function is only available in Network mode. It allows the STI to verify that a command is received completely in a given time frame. When the CTT switch is in the OFF position, the CTT function is disabled. When the CTT switch is in the ON position, the CTT function is enabled. The CTT function is also part of the Firmware Control Code. See Section 3.7.1 of this manual for information on the Firmware Control Code.

SW1.5 - Temperature Units: When the Temperature Units switch is in the OFF position, temperature data is displayed in degrees Fahrenheit. When in the ON position, temperature data is displayed in degrees Celsius. This sets the temperature units for both Stand-alone and Network modes of operation. The DDA tank gauge must always transmit data in degrees Fahrenheit and let the STI perform the conversion if degrees Celsius is desired.

SW1.6 - Level Units: When the Level Units switch is in the OFF position, level data is displayed in decimal inches. When in the ON position, level data is displayed in fractional feet and inches. This sets the level units for both the Stand-alone and Network modes. When operating in fractional mode, level is displayed as feet, inches, and sixteenths of an inch. A single quote (') icon separates feet and inches. A double-quote (") icon separates inches and sixteenths of an inch. The negative sign can not be shown in fractional mode, but the decimal

point will come on to indicate a negative number.

2.7.3 Dip Switch #2 (SW2 - Stand-alone mode)

When the STI is set for Stand-alone mode, SW2 sets the number of DDA tank gauges to be scanned and the DDA command to be sent to each gauge. Switches SW2.1, SW2.2, and SW2.3 set the number of gauges. The switches SW2.4, SW2.5, and SW2.6 set the DDA command to use. This allows you to program from 1 to 8 gauges to be scanned and offers 8 command choices. See section 3.1 for additional information about Stand-alone mode operation.



Figure 2.10 DIP Switch #2 Functions (Stand-alone mode)

NOTE:

In Stand-alone mode, the switch decoding circuitry interprets the switch positions opposite to the ON label on the switch housing. For example, switches in the ON position are read as binary 0. Setting switch SW2.1 to the OFF position is then read as binary 1. Setting SW2.2 to the OFF position is read as binary 2. Setting both SW2.1 and SW2.2 to the OFF position is read as binary 3, and so on.

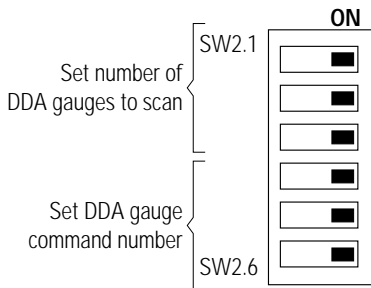

Scan one DDA gauge using STI command 0 (i.e. custom command table; see section 3.1 for STI/DDA Command Reference chart)

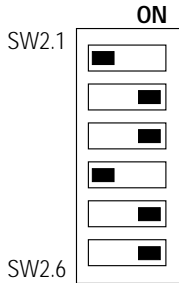

Scan two DDA gauges using STI command 1 (level 1)

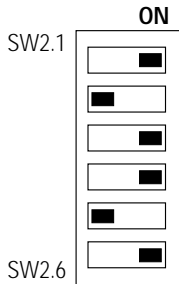

Scan three DDA gauges using STI command 2 (level 1, level 2)

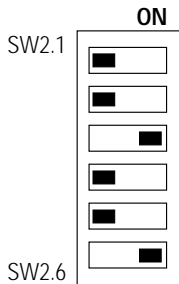

Scan four DDA gauges using STI command 3 (level 1, level 2, Avg temp)

Figure 2.11 Example Stand-alone mode SW2 settings

2.7.4 Dip Switch #2 (SW2 - Network Mode)

When the STI is set for Network mode, SW2 serves as the network address decoding switch. Each STI in Network mode requires a unique address. The address is decoded as a binary offset from the base address of 80 hex. Since there are six switches each having two positions, there are a total of sixty-four possible addresses ($2^6 = 64$) ranging from 80 hex to BF hex. The base address of 80 hex is set by putting all switches in the ON position (SW2.1 to SW2.6). The address 81 hex is set by putting SW2.1 in the OFF and SW2.2 to SW2.6 in the ON position. To set the next address of 82 hex, set SW2.1 to ON, SW2.2 to OFF, and SW2.3 to SW2.6 to ON. This binary counting pattern continues for all addresses until the last available address is set.

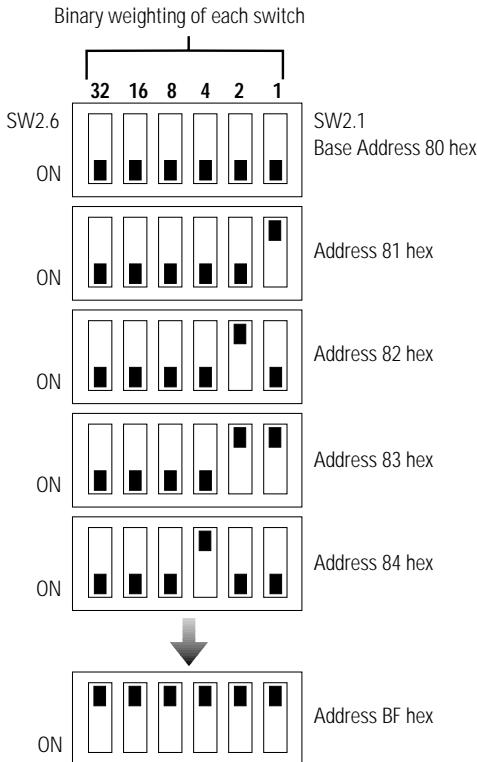

Figure 2.12 Example Network mode SW2 Address Settings

NOTE:

In Network mode, the address switch decoding circuitry interprets the address switch positions opposite to the ON label on the switch housing. For example, switches SW2.1 through SW2.6 in the ON position are read as binary 0, establishing the base STI communication address of 80 hex (128 decimal). Setting switch SW2.1 to the OFF position adds 1 to the base address creating 129 decimal (128 + 1). Setting switch SW2.2 to the OFF position adds 2 to the base address creating 130 decimal (or 82 hex). Setting both switches SW2.1 and SW2.2 to the OFF position will add 3 (128 + 2 + 1), and so on.

2.7.5 Push Button Switch (SW3 - Reset)

The Reset switch (SW3) only functions when the STI is in Stand-alone mode and is used to force a reset to the microprocessor. It is necessary to reset the microprocessor when any dip switch changes have been made. The STI only reads the DIP switches on power up and during a reset. The "RESET" message will be displayed briefly, then the STI begins scanning gauges and displaying data.

2.8 Initial Power Up

At this point you have mounted your STI display, run your network cabling, and made all necessary switch settings. Now you are ready to power up the system and perform an initial check. Below are some things to consider before initially applying power to the system:

Stand-alone mode:

1. Verify all wiring is complete and in accordance with the guidelines provided in this manual.
2. Verify that each DDA gauge connected to the STI host has correct address switch settings. The first DDA gauge should

be addressed as C0 hex. Each additional DDA gauge must have an incremental address (i.e., second DDA must have the address C1 hex, etc.). See the DDA tank gauge operation manual for more information regarding the DDA tank gauge.

3. Verify that the STI switch settings are set for Stand-alone mode. Refer to sections 2.7.2 and 2.7.3 in this manual for additional information regarding Stand-alone mode switch settings.

Network mode:

1. Verify all wiring is complete and in accordance with the guidelines provided in this manual.
2. Verify that each STI has had the network address correctly set and that the switches have been set properly for Network mode. Refer to sections 2.7.2 and 2.7.4 in this manual for additional information regarding Network mode switch settings.
3. Verify that the host computing device is set-up to accommodate the STI displays. Consult the manual for the host device or host software manual if there are questions regarding that device.

Now apply power to the system. What appears on the LCD display is dependent on the mode of operation selected. If you are operating in Stand-alone mode, the "RESET" message will appear on the LCD display. After that, DDA level and temperature information will appear. If you are operating in the Network mode, it may take up to several seconds for information to appear on the LCD screen. It depends on how the host device is programmed to work and what type of data is being retrieved from the DDA gauge, etc. If you do not see information displayed within a reasonable period of time, see section 4.0 of this manual (Troubleshooting and Maintenance).

If you are planning to write your own software communication driver for the DDA/STI network, consult sections 3.1 and 3.4 for network protocol information.

2.9 Display Contrast Adjustment

The LCD display contrast (darkness) can be adjusted using the contrast adjustment screw located on the lower left section of the display panel. Turn the adjustment screw counterclockwise to lighten the LCD display and clockwise to darken the display.

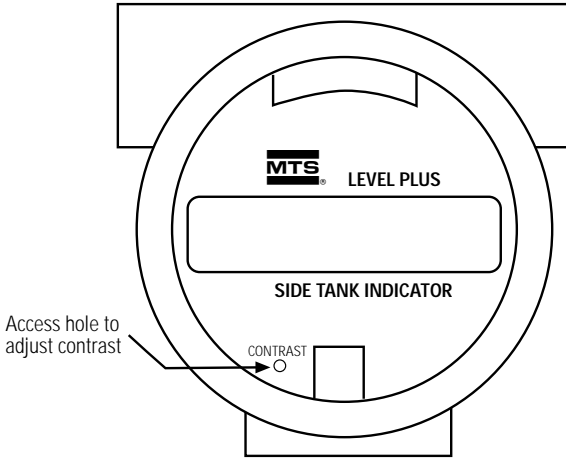

This view shown with cover removed

Figure 2.13 Location of Contrast Adjustment

NOTE:

Use a small screwdriver and do not force screw. The adjustment potentiometer easily rotates 3/4 turn from left to right.

3.0 OPERATION

This section describes the operation of the STI in both Stand-alone and Network modes. Command protocol and network timing issues are also discussed. Note that the DIP switch SW2 has a different function depending on the mode selected (Stand-alone or Network mode).

This section makes references to the DDA tank gauge manual and the DDA Level Plus Monitor manual. You may want to use these manuals as reference materials when designing your system.

3.1 Stand-alone Mode

In Stand-alone mode the STI becomes the network host (controller). It can poll data from 1 to 8 DDA tank gauges. The number of gauges is set by SW2.1, SW2.2 and SW2.3. The STI will always poll the first DDA tank gauge set at address C0 hex (192 decimal). Additional gauges must be incrementally addressed as C1 hex (193 decimal), C2 hex (194 decimal), etc. up to C7 hex (199 decimal) for the last (8th) gauge. The STI issues level and/or temperature commands across the network. The DDA gauges receive commands and transmit data back across the network. The STI displays the data as it is received. The "SCAN" icon and the scan number icons on the LCD indicate which DDA gauge is active. There are icons that indicate the type of data being displayed at any given time ("LEV1", "LEV2", and "TEMP"). Associated with each of these icons are "HI" and "LO" icons which indicate if alarm set points have been exceeded.

For various reasons, messages can be displayed on the LCD display. An example of this would be a communication error. Below is a list of all messages that the STI can generate and display on the LCD in Stand-alone mode, along with a brief description of each.

<u>Message</u>	<u>Meaning</u>
RESET	This message indicates that the microprocessor is in a state of reset. This can occur when: <ol style="list-style-type: none"> 1.) Power is applied 2.) Reset switch (SW3) has been depressed. 3.) Watchdog timer circuit not strobed by the microprocessor within specified time frame. 4.) The +5 V supply goes out of tolerance.
NO ECHO	An address/command sequence was sent to a DDA gauge but the gauge failed to echo back the address /command.
BAD ECHO	An address/command sequence was sent to a DDA gauge and the echoed address/command returned did not match what was sent.
NO DATA	An address/command sequence was sent to a DDA gauge and the echoed address/command was returned. Data was not completely received within the specified time frame.
BAD CS	The checksum feature is enabled and the data communication sequence received from the DDA gauge did not contain the proper checksum or no checksum at all. Check to make sure that the checksum feature is enabled on all DDA gauges.
BAD CONFIG	An illegal switch configuration on SW2. See section 2.7 for help in setting proper switch configurations.

The command to be issued to DDA gauges from the STI is set by using switch SW2.4, SW2.5, and SW2.6. All gauges are sent the same command unless these switches are configured to read the STI custom command table. In that case, each gauge can be sent a different command as programmed in the STI EEPROM memory. Refer to section 2.7 of this manual for details on setting the number of gauges or the command used. The following list shows all of the commands that are available for use in Stand-alone mode. The three columns on the right side of the table show the switch settings necessary for using the command. If an asterisk (*) appears before the command description, that indicates the command is available only from the custom command table. Any of the listed commands can

be used with the custom command table. If you want to use different commands for different gauges you must use the custom command table. Use STI command 16 hex to write the commands to the command table. Use command 11 hex to read the custom command table.

NOTE:

The STI must be in Network mode to write commands or read them from the command table.

STI Command Number	Data types displayed	Displayed Resolution	DDA Command (HEX)	DDA Command (DECIMAL)	SW2.4	SW2.5	SW2.6
1	Level 1	0.1 inch	0A	010	ON	ON	ON
0	*Level 2	0.1 inch	0D	013	OFF	OFF	OFF
2	Level 1, Level 2	0.1 inch	10	016	ON	ON	OFF
3	Level 1, Level 2, Avg. Temp	0.1 inch	2B	043	ON	OFF	ON
4	Level 1	0.01 inch	0B	011	ON	OFF	OFF
0	*Level 2	0.01 inch	0E	014	OFF	OFF	OFF
5	Level 1, Level 2	0.01 inch	11	017	OFF	ON	ON
6	Level 1, Level 2, Avg. Temp	0.01 inch	2C	044	OFF	ON	OFF
0	*Avg. Temp	1 degree	19	025	OFF	OFF	OFF
0	*Avg. Temp	0.2 degree	1A	026	OFF	OFF	OFF

* Indicates that the command is only available via the custom command table programmed into the STI EEPROM memory.

STI Command Number Reference Table

The reset switch (SW3) must be depressed after making changes to any of the dip switches on an STI unit. The micro-processor will only read the switch configuration after a reset has occurred. Upon pressing the reset switch, you should see a “reset” message on the LCD screen for a brief period. The STI will begin polling with DDA gauge #1 or C0 hex (192 decimal).

If the alarming feature is enabled, the STI checks all level and temperature data and compares it to the set points programmed in EEPROM memory. If a value is equal to or less than the low set point value, the “LO” icon for that level or temperature will come on. If the value is equal to or higher

than the high set point value, the “HI” icon for that level or temperature comes on.

The overall scan rate of the STI in Stand-alone mode depends on the commands being sent to DDA gauges, the scan delay time programmed into the STI scan delay control code, and the number of DDA gauges that the STI is polling. Unless you are using the custom command table with different commands programmed for each gauge, scan time should be approximately the same from one DDA interrogation to the next. With the custom command table function, the scan rate may vary if the selected commands are different. In general, level commands are quicker than temperature commands or combination level/temperature commands. If necessary, use the scan delay control code (part of the STI firmware control code) to adjust the timing to a desired level.

It may be necessary to make changes to certain parameters stored in EEPROM memory such as alarm set points or custom commands. This will require that you temporarily put the STI in Network mode. Before doing that, make sure that you document the current switch configuration. Another device must then act as the network host. This temporary host must have a terminal function to allow commands to be sent to the STI and data from the STI to be displayed. MTS offers a hand-held terminal (Model: HT100), which is designed to make parameter changes to the DDA gauge and/or the STI. A personal computer with MTS software DDASETUP can also be used to make any necessary changes. Refer to Section 3.2 for instructions on operating the STI in Network mode. Refer to Section 3.7 for instructions on programming the STI. After making changes, reset the DIP switch configuration to its original settings putting the STI back into Stand-alone mode.

3.2 Network Mode

In Network mode a host computing device is required to control the network. This can be a PC (running LPS-80 software or some custom application), an MTS Level Plus Monitor (LPM), Programmable Logic Controller (PLC) or HT100. If you are adding one or more STI displays to an existing DDA network, you already have a host device in place. Your host must be capable of operating an STI display. If this is a new installation, you will need to select a host device. You should choose your

host device based on the specific application. It must have the capability to be programmed to work with the STI device protocol. Refer to the users manual for the particular host device or software package for information on how it can be used with an STI display.

In Network mode, the STI must have data transmitted to it for display. There are several commands available for this purpose, depending on the type of data to be displayed. There are two commands available for level/temperature display. The first command (18 hex) displays level and/or temperature data. The second command (19 hex) provides the same level and temperature display with the addition of extended icon control. These two commands use level and/or temperature data formatted in a similar fashion to that of data transmitted from a DDA tank gauge. There are also two commands available for generic data display. The first command (1C hex) displays a field of 16 characters on the LCD. The second generic display command (1D hex) displays a field of 16 characters and has extended icon control. These last two commands allow various types of data to be displayed on an STI display. For example, volumetric information from an MTS LPM.

The overall scan rate of the STI in Network mode depends on the host-issued commands, and the number of devices (i.e., DDA gauges and STI displays) that the host is polling.

In addition to the factors listed above, scan rate is also affected by the 400 millisecond delay generated by all four display commands (18 hex, 19 hex, 1C hex and 1D hex). Once a display command (part 2) is issued by the host, the data format is checked. If the format is correct, the data is displayed and the "SCAN" icon is enabled for 400 milliseconds. The "SCAN" icon is then disabled and the <ACK> character is sent by the STI back to the host. If the data sent by the host is not formatted correctly, a <NAK> sequence is issued immediately and there is no 400 millisecond delay.

3.3 General Network Mode Protocol Information

The STI display is designed to function in an intrinsically safe EIA-485 network allowing up to 20 devices to be multi-dropped on one communication line. A device can be a DDA tank gauge or an STI display. The network requires a four wire interface to provide both power and communications to each of the devices located in the hazardous area.

The EIA-485 network consists of a single host and one or more (up to twenty) networked slave devices. Each of the slave devices must have a unique address (switch programmable). This address is used by the host to initiate a communication sequence with a slave device. The STI hardware contains a command decoder that supports up to 32 different commands. The host uses the address byte of the device it wants to communicate with followed by a command byte. The addressed device will “wake up” and respond by transmitting its unique address followed by the received command. The device will then perform the requested action or wait for additional command information from the host. Most commands associated with the STI (unlike the DDA tank gauge) require two parts before it can be executed.

NOTE:

This is a 2-wire differential communication interface and all data transmissions must be half duplex. Only one device can transmit data at a time. All communications are limited to 4800 baud.

The serial communication protocol has a standard asynchronous serial data transmission format. All words are transmitted serially as 11 bits. Each word begins with a start bit, followed by 8 data bits (bit D1 transmitted first), an even parity bit and one stop bit. See example 1.

Example 1 - Serial data transmission format

0 X X X X X X X P 1

0 X X X X X X X P 1 - Start Bit

0 X X X X X X X P 1 - D1 Bit

0 X X X X X X X P 1 - D8 Bit

0 X X X X X X X P 1 - Parity Bit

0 X X X X X X X P 1 - Stop Bit

After the address decoder circuitry receives the 11 bit word, an even parity check is performed across the 8-bit data field. If a parity error is found, the word is ignored and the decoder resets for the next transmission. If the parity check is good, the decoder checks for a valid address byte. The address decoder circuitry uses the D8 bit to distinguish the difference between address bytes and command bytes. See example 2. Valid address byte values for an STI display range from 80 hex to BD hex. Address values BE hex and BF hex are reserved for test functions. Address bytes from C0 hex to FF hex are reserved for DDA tank gauges.

Example 2 - Address byte

X X X X X X X 1 - D8 Bit

(8 bit word - shown as D1 on the left)

If the received address byte matches the local STI address, the STI power supply circuitry is activated. If a valid address byte has been found, the decoder circuitry checks to see if the next received word is a command byte. Valid command byte values include 00 hex to 7F hex. In addition, all data byte values are restricted to be within the range of 00 hex and 7F hex. See example 3.

Example 3 - Command and Data bytes

X X X X X X X 0 - D8 Bit

(8 bit word - shown as D1 bit on left)

A parity check is then performed on the command byte. If the parity check is good, the eight bit data word is latched into a command buffer. The command buffer is read by the STI software to determine which command to execute. If the parity check fails, the command byte is rejected and the old com-

mand (from the previous interrogation sequence) will remain in the command buffer. The STI hardware can not determine if the current command was possibly rejected. The host computer must then verify if the correct command was received by reading the echo of the address byte and command byte sent by the STI display. This is the only guaranteed way to determine that both the address and command bytes were received properly.

This method also insures proper verification even if the parity check fails to detect a multiple bit data error in either the address byte or command byte. If the host computer determines that either the address byte or command byte has been corrupted, it must wait the appropriate time-out period and ignore the received message from the STI display that was improperly interrogated. The time-out period is variable and is based on the duration of the selected STI command.

The DDA/STI communication protocol consists of two or more parts: the interrogation sequence generated by the host computer (or STI in Stand-alone mode) and the data response generated by the interrogated DDA gauge. The host interrogation sequence always consists of an address byte followed immediately by a command byte.

<address byte> <command byte>
(80 hex to BD hex) (00 hex to 7F hex)

The maximum delay between the address byte and the command byte is 5 milliseconds. The STI display will not receive the new command byte if this delay period is exceeded (and leaving any previous command byte in the command buffer). Consult the previous section for additional information on verification of the address/command bytes. An example of a communication sequence to display data on an STI set for address 80 hex is shown in example 4.

Example 4 - Address/command sequence

<80><18>
| |
| | Command 18 hex (24 decimal)
Address 80 hex (128 decimal)

The STI display will respond by transmitting its own local address and the command that was received from the host. This serves two purposes. The first being a simple identification that the correct STI received the correct command and that it is currently active. The second purpose is to reset the STI address/command decoder circuitry for the next interrogation sequence.

NOTE:

If the STI does not respond to the first interrogation by the host, the address/command decoder will be left in an intermediate state. If this occurs, the host will have to re-interrogate the respective STI display again to reset the address/command decoder circuitry. This hardware feature must be considered when writing software communications drivers to access an STI display.

After the STI display has transmitted its local address and received command, it then waits for the second part of the command to be sent by the host. See Example 5. The second part is necessary because it contains the data to be displayed on the LCD display. The host must transmit this second part within one second or the STI will cancel the current communication sequence and return to sleep mode (assuming the CTT function is enabled).

Example 5 - Part two of command 18 hex

<SOH>100.00:200.00:30.0<EOT>ccccc

<SOH>100.00:200.00:30.0<EOT>ccccc - <SOH> character (01 Hex)

<SOH>**100.00**:200.00:30.0<EOT>ccccc - Level 1 data field

<SOH>100.00:**200.00**:30.0<EOT>ccccc - Level 2 data field

<SOH>100.00:200.00:**30.0**<EOT>ccccc - Temperature data field

<SOH>100.00:200.00:30.0<**EOT**>ccccc - <EOT> character (04 Hex)

<SOH>100.00:200.00:30.0<EOT>**ccccc** - Appended 5-character checksum

All STI display commands support a checksum calculation mode that allows the STI to check the integrity of transmitted data from the host device. The actual checksum value that is transmitted is the compliment (2's compliment) of the calculated value. The checksum scheme is based on a 16 bit summation of the data within the transmitted block (including all control characters) without regard for overflow. The two byte result of the summation is then complimented and appended to the transmitted data block. The compliment process makes the final checksum comparison more efficient in that the checksum result added to its compliment will always result in a zero sum for uncorrupted data transmissions. Checksum data (two hex bytes) can range from 0000 hex to FFFF hex. Since the communication network only allows transmitted data values between 00 and 7F hex, special processing is required on the hex checksum value before it be transmitted. The two byte hex value is first converted to an ASCII representation of the decimal checksum value before transmission. For example: a checksum value of FFFF hex is transmitted as 65535.

NOTE:

The checksum value consists of five ASCII characters ranging from 00000 to 65535. The checksum function can be enabled or disabled using switch SW1.3.

Message transmitted from DDA gauge (command 12 Hex):

<STX><265.322:109.456><ETX>64760

Hex character equivalent of transmitted data record including <STX> and <ETX> characters:

02, 32, 36, 35, 2E, 33, 32, 32, 3A, 31, 30, 39, 2E, 34, 35, 36, 03

Two byte Hex summation of data: 0308 Hex

Two's compliment: FCF8 Hex

Convert to decimal ASCII: 64760

To verify transmitted data from the DDA gauge, perform the two byte Hex summation over the data record (including

<STX> and <ETX>) as shown above. The result in this example is 0308 Hex. Then convert the decimal ASCII checksum value back to Hex (i.e. 64760 to FCF8 Hex). Add the Hex summation value to the Hex checksum value and the result will be zero (disregarding overflow) for uncorrupted data.

$$0308 \text{ Hex} + \text{FCF8 Hex} = 0000 \text{ Hex}$$

After the STI receives the second part of the command from the host, it verifies that the data was received in the proper format. Then, if the data was formatted correctly, the STI parses out the data and displays it. Once the STI has displayed the data, it then sends an acknowledgment <ACK> sequence to the host to let the host know the data was received and displayed properly. If for some reason the data is not formatted correctly from the host, or if the LCD controller fails to display the data due to a malfunction, a negative acknowledgment <NAK> sequence is sent to the host.

Example 6 - Acknowledgment Communication Sequence

<ACK>ccccc

Example 7 - Negative Acknowledgment Communication Sequence

<NAK>Exxx<ETX>ccccc

In the case of a negative acknowledgment, an error code is also provided. Refer to Section 3.8 of this manual for a list of error codes and descriptions. Also, note that the checksum characters are appended to the acknowledgment and negative acknowledgment communications sequences.

After a communications sequence is completed between the STI and host, the host must wait 50 milliseconds before another communications sequence can take place. This delay is required to allow the STI to enter sleep mode and release the network communications lines. The communications sequence in the above example is typical of all STI display commands. There are other types of commands and the sequence will change depending on the type of command being used. Refer to Section 3.5 on Command Protocol for detailed information on each command available for use with the STI.

3.4 Network Mode Timing Considerations

The DDA/STI network has several timing constraints to be considered when designing and coding communication drivers. The DDA/STI network follows the EIA-485 standard which defines a multi-drop communication interface that uses differential drivers and receivers operating in a half duplex mode. In this configuration each driver and receiver are wired together as shown in Figure 3.1.

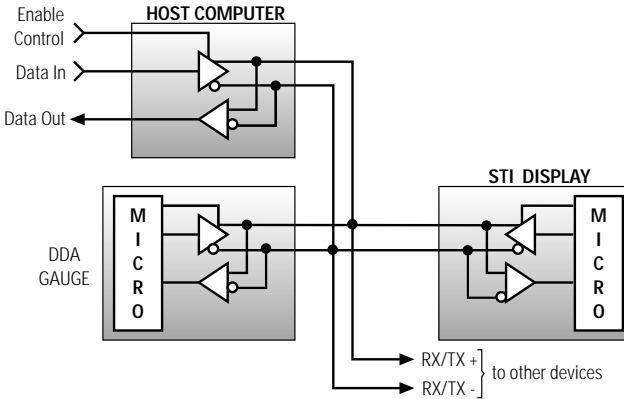

Figure 3.1 EIA-485 Multi-Drop Network

This configuration requires that the driver in each network device be disabled (high impedance) except when that device is ready to transmit data. To keep devices from transmitting data at the same time, one device is selected as the host (or master). For the DDA/STI network, the host computer (or other communication interface) is the master, and controls the communication timing and protocol. The STI (in Network mode) or DDA tank gauges act as slave devices and only transmit data when requested by the host computer device. In this fashion, the host computer enables its driver and transmits the address/ command interrogation sequence. After the address/command has been completely transmitted, the host disables its driver to allow reception of the data from the slave device. The slave device with the matching address then becomes active, enables its driver and transmits the address/command echo followed by any requested data. The slave device then disables its driver and returns to sleep mode. Since all devices operate independently, certain timing con-

straints are imposed on the protocol to eliminate multiple devices from transmitting data simultaneously.

NOTE:

Many available communications cards (line drivers) for use with the host device use a special control line input to control the enabling and disabling of the EIA-485 driver. Typically this input is connected to the computers RTS or DTR communication port control line. The computer can then control the state of the driver by toggling the RTS or DTR signal lines via software control. An example of this control method is shown in the next section. Other control methods are also used depending on the manufacturer of the equipment.

The network protocol timing sequences are shown in figure 3.2. This timing diagram shows the relationship between the transmitter enable control line (i.e., RTS line), data transmitted by the host and data transmitted by the STI.

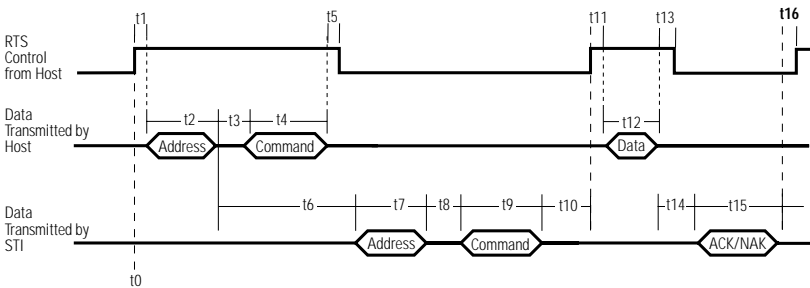

Figure 3.2 STI Network Mode Timing Diagram

1. The start of the sequence begins when the host enables its EIA-485 driver to transmit the address/command bytes. This is shown on the timing diagram as t0. In this example, the host enables the driver by raising the RTS control line of the computer communication port.

2. After the driver is enabled, the host performs a small time delay, shown here as t_1 , to let the communication lines transition from a high impedance state to an active (enabled) state. This typically requires no more than 1 millisecond. If the communication lines are extremely long, additional time may be required due to additional cable capacitance.
3. The host then transmits the address byte followed immediately by the command byte. For 4800 baud transmission rates, the time to transmit one byte (11 bit word size) is fixed at 2.3 milliseconds. Time delays t_2 and t_4 are fixed at 2.3 milliseconds. Time delay t_3 is the interbyte transmission time. Normally t_3 is at least one bit time (0.21 milliseconds @ 4800 baud) which is controlled by the computer communications hardware. Sometimes software overhead can extend this delay. The maximum permissible delay for period t_3 is 5 milliseconds. The maximum total delay for periods t_2 , t_3 , and t_4 is 9.6 milliseconds.
4. After the host transmits the address and command bytes, it must then disable its driver to allow the STI to transmit its address/command echo. Before the driver is disabled, the software must insure that the command byte has been completely transmitted. This can be done by observing control flags from UART of the communication port, such as Transmit Register Empty (TRE) and Transmit Holding Register Empty (if the UART is doubled buffered). Software delay methods based on maximum character transmission times for 4800 baud rates can also be used but are less reliable. Once it has been verified that the command byte has been completely transmitted, an additional delay should be added before the driver is disabled. This delay (t_5) will insure that the data has propagated the network wiring before the driver goes to the high impedance (disabled) state. A delay period of $t_5 = 1$ millisecond is adequate for most long cable runs. The maximum delay allowed for t_5 is based on the time period t_6 which is fixed in the STI hardware at $28 (\pm 2)$ milliseconds. The host driver should be disabled at least 5 milliseconds before the STI enables its driver and begins transmission of the address/command echo. Assuming the maximum delay of 5 milliseconds for period t_3 , and 2.3 milliseconds for t_4 , and that the host driver should be disabled for 5 milliseconds before the STI begins

transmitting data, the maximum delay for t_5 then is 13.7 milliseconds.

NOTE:

If t_3 is less than 5 milliseconds, then the maximum delay for t_5 can be extended by the difference (5 milliseconds - t_3 actual).

5. The STI will begin to transmit the address/command echo in 28 (± 2) milliseconds after the address byte is received from the host computer. This is defined as period t_6 and is fixed by the STI hardware. With a baud rate of 4800, the address echo is transmitted in 2.3 milliseconds (period t_7). The inter-byte delay period (t_8) for the STI display is fixed at 0.1 milliseconds and the command echo is transmitted in 2.3 milliseconds (period t_9).
6. Period t_{10} is the time required for the STI electronics to disable its driver. t_{10} is fixed in the STI hardware at 1 millisecond. At the end of t_{10} , the host device can re-enable its driver to transmit the second part of the command sequence (data).
7. Period t_{11} is the standard “enable to transmit” delay. This is the same as t_1 described earlier.
8. Period t_{12} is the time required for the host to transmit the second part of the command sequence (typically the data to display). This is a variable period and is based on the selected STI command and the number of characters being transmitted. The period will be $n \times 2.3$ milliseconds where n is the number of characters being transmitted.
9. Period t_{13} is the standard transmitter disable delay. This is the same as t_5 described earlier.
10. Period t_{14} is the time required for the STI to parse and check the second part of the host command sequence. This is a variable period based on the selected STI command. The typical module response time (TMRT) for each command is listed in the STI command section 3.5 of this manual.

11. Period t15 is the time required for the STI to transmit the STI acknowledged sequence. If the received command was accepted, the STI will transmit the ACK character (06 Hex) followed by the optional 5 character checksum (6 characters total). Period t15 will then be 6×2.3 milliseconds per character or 13.8 milliseconds. If the received command was not accepted, the STI will transmit the NAK character (15 Hex), the four character STI error code (Exxx), the ETX character (03 Hex) and the optional 5 character checksum (11 characters total). Period t15 will then be 11×2.3 milliseconds per character or 25.3 milliseconds. See section 3.3 for additional information about the STI ACK/NAK response.
12. After the STI display has completed a communications sequence, it will disable its driver and return to inactive or "sleep" mode. The electronics require 50 milliseconds to make the transition from active mode to inactive mode. Another networked device cannot be interrogated until time period t16 = 50 milliseconds has elapsed.

Other protocol considerations

1. If an STI display fails to respond to an interrogation from the host device, the STI address/command decoder circuitry may be left in an intermediate state. Normally the address/command echo from the STI microprocessor resets the display decoder circuitry. If the STI fails to echo the address/command bytes, then it would be the next address/command byte interrogation from the host device that would reset the decoder circuitry. Consequently the display will not respond to the second address/command transmission from the host device. This protocol feature should be considered when adding retry functions to STI communication interface drivers.
2. Use the STI 'Data Error Detection' function to verify the integrity of the data transmitted to the STI display.
3. Certain EIA-485 communication cards (and EIA-232 to EIA-485 converter cards) allow user control of the receiver function. This feature must be considered when developing communication drivers. Due to the half-duplex EIA-485 loopback wire connections, all data that is transmitted by the host computer device will be "echoed" into the receiver inputs. If the receiver function is enabled, then the host transmitted data along with the STI display transmitted data will be received into the computer receive buffer.

3.5 Command Protocol

The commands for STI displays work much the same way as the commands for DDA tank gauges. For an STI to respond to a command, the STI must be operating in the Network mode. If you have an STI working in Stand-alone mode and you want to change an alarm set point for instance, you must first configure it for Network mode. To configure an STI for Network mode, put set SW1.1 = OFF and SW1.2 = ON (the address switches must also be set to the desired address). Remember to reset the STI mode (if you changed it) when finished.

The commands are divided into several command sets. The different command sets may vary in the way that they are used. The first command in each command set will be shown in detail. The remaining commands within that command set will be used in that same way.

In this section, certain ASCII characters are represented as text enclosed in brackets < >. For example, the term <STX> represents the ASCII character 02 hex. Also, place holders are used for showing the basic format for unspecified data. For example, "cccc" is used in many places to represent the checksum calculation (whose value is unknown) that may be appended in some communication sequences. Where necessary, typical module response time (TMRT) and typical data transmission time (TDTT) values are specified for commands. The TMRT value will not be specified on commands that are usually entered manually. The TMRT and TDTT values provided include data error detection (DED) calculation overhead.

Command Set 1 - 00 Hex to 07 Hex (Special Control Commands)

Command 00 Hex - Module disable command

Issuing this command will force an active module to be disabled (go to sleep mode). This command does not need to be preceded by an address byte and can only be issued when there is no communication activity on the network. During normal operation, a STI module will force itself back into sleep mode if any data is transmitted on the network by any other device. This is a safety feature added to the firmware to avoid data collisions on the network.

Command 01 Hex - Module identification command

This command is used to determine the module type. The STI module will transmit the module identification message.

Data Format

- <STX>STI<ETX> ccccc
- <STX> is ASCII 02 hex
- Fixed length record containing the three ID characters "STI".
- <ETX> is ASCII 03 hex
- The five character checksum is appended after the <ETX> only if the checksum feature is enabled.

TMRT - 15 mS

TDTT - 23 mS

Commands 02 Hex to 07 Hex - Reserved for factory use.

Command set 2 - 08 Hex to 0C Hex (Test Mode Commands)

STI test commands consist of two components (or data communication sequences). The first component of any test command consists of the usual <addr><command> data necessary to activate the respective STI module. The second component consists of a special access code for each test command.

Command 08 Hex - RAM read/write test

Host issued command (part 1)

Data Format: - <address><command>
 - <address> is the STI address (80 hex to BF hex)
 - <command> is the STI command being issued.

After the address and command have been received by the host, the respective STI will wake up and transmit or echo its local address and received command. The STI will remain active, waiting for the second part of the test command to be issued by the host. If the second part of the test command is not received within one second (if CTT function is enabled), or the command is not received in the proper format, the STI will return to sleep mode.

Host issued command (part 2)

Data Format: - <SOH>STITx<EOT>
 - <SOH> is ASCII 01 hex
 - Fixed length data record containing one field. The data field contains five characters which are always in the form "STITx". The "x" defines the test command being issued. The character "1" signifies the RAM test. So for this test, the command would be
 " <SOH>STIT1<EOT>"
 - <EOT> is ASCII 04 hex

STI Response (after completion and test passed)

Data Format - <ACK>ccccc
 - <ACK> is ASCII 06 hex. This character is sent by the STI module to confirm to the host that the test was successfully completed (without errors).
 - The optional 5 character checksum shown as "ccccc" can range from 00000 to 65535.

STI Response (after completion and test failed)

Data Format - <NAK>Exxx<ETX>ccccc

- <NAK> is the ASCII 15 hex. This character is sent by the STI module to confirm to the host that the test was not successfully completed (error detected).
- Exxx is the general format for STI error codes. "E" is ASCII 45 hex and "xxx" is the ASCII representation of the numeric error code which can range from "000" to "999". See Section 3.8 of this document for specific error code descriptions.
- <ETX> is ASCII 03 hex.
- Optional five character checksum.

TMRT = 350 mS

TDTT = 14 mS

All STI test commands adhere to the communications sequence as described above and must include the following components:

1. Host issued command (part 1): <address><command>
2. STI module response: <address><command> echoed
3. Host issued command (part 2): <SOH>STITx<EOT>
4. STI response: <ACK> or <NAK>Exxx (with optional five character checksum).

Other test commands below will include only the data format for the second part of the command. Follow the same format as shown above for command 08 hex. See Section 3.8 for additional information regarding error codes.

Command 09 hex - ROM data checksum test

This test verifies that the program contained in the ROM memory is not corrupted and that each line of the address and data busses are functioning.

Host issued command (part 2):

Data Format - <SOH>STIT2<EOT>

TMRT = 1.2 seconds

TDTT = 14 mS

Command 0A Hex - Not defined

Command 0B Hex - Communication hardware test

The STI module will output the following characters during this test (47 characters total):

<SOH><STX><ETX><EOT><ENQ><ACK><NAK>ABCDEFGHIJKLMNPOQRSTU-
VWXYZ.0123456789-:

The last character will be a blank space. A final <ACK> or <NAK>E908 will follow along with the optional five character checksum. This test is used to verify that all of the hardware associated with the communications circuitry is functional.

Host issued command (part 2):

Data Format - <SOH>STIT3<EOT>

TMRT = 10 mS

TDTT = 123 mS

Command 0C Hex - LCD (Liquid crystal display) test

This test is used to turn on all LCD segments and icons for visual verification and does not generate any error codes based on failed segments. It only generates an error code if the I.C. controlling the LCD does not respond to the microprocessor. When the command is issued, the STI keeps the LCD segments on for three seconds. The <ACK> is not issued until the segments are turned off.

Host issued command (part 2)

Data Format - <SOH>STIT5<EOT>

TMRT = 3 seconds

TDTT = 14 mS

Command set 3 - 0D Hex to 12 Hex (High Level Memory Read Commands)

For command set 3, simply issue a <address><command> sequence and the STI will respond with the echoed address/command. The requested information will follow in the format for any given command as shown.

Command 0D Hex - Read LOW alarm limits

Alarm limits apply to Stand-alone mode only. In Network mode, all alarm limit comparisons and LCD alarm icons are managed by the host device. All alarm limit values are stored as decimal values with two decimal places of resolution (i.e. hundredths). If the STI module is programmed to respond in fractional units, the level data from DDA gauges is always rounded to the nearest sixteenth (1/16) of an inch before being compared with alarm limits. If the STI has temperature units set for degrees F then the alarm values will be in degrees F, likewise with degrees C. If the temperature unit is changed, alarm set points must be changed accordingly.

Data Format - <STX>ddd.dd:ddd.dd:ddd.dd:.....<ETX>cccc
 - <STX> is ASCII 02 hex
 - Variable length record containing 24 fields. Each field is separated by a colon. Data in each field contains one to three characters to the left of the decimal and two characters to the right.
 - <ETX> is ASCII 03 hex
 - Optional five character checksum

TMRT = 304 mS

TDTT = 402 mS

Command 0E Hex - Read HIGH alarm limits

- Data Format
- <STX>ddd.dd:ddd.dd:ddd.dd:.....<ETX>cccc
 - <STX> is ASCII value 02 hex
 - Variable length record containing 24 fields. Each field is separated by a colon. Data in each field contains one to three characters to the left of the decimal and two characters to the right.
 - <ETX> is ASCII 03 hex
 - Optional five character checksum

TMRT = 304 mS

TDTT = 402 mS

Command 0F Hex - Read factory serial number and software revision

The serial and model number as well as the software revision are useful when contacting the factory about any issues regarding the operation of the STI display.

- Data Format
- <STX>ddddddddd.....:Vd.ddd<ETX>cccc
 - <STX> is the ASCII value 02 hex
 - Fixed length data record of 57 characters divided into two fields.
 - The first data field is fixed at fifty characters to the left of the colon and contain the serial number/model number information. Fields are separated by a colon.
 - The second field contains the software revision and is fixed length of six characters.
 - <ETX> is the ASCII 03 hex
 - Optional five character checksum

TMRT = 90 mS

TDTT = 148 mS

Command 10 Hex - Read firmware control code

Some of the individual control codes described here work in conjunction with SW1. See Section 3.7.1 of this manual for additional information on how the firmware control code works, and how to use it.

- Data Format
- <STX>d:d:d:d:d:d:d:d<ETX>cccc
 - <STX> is ASCII 02 hex
 - Fixed length record with eight data fields. Each field contains only one character. Each field is separated by a colon.
 - The first data field is the Data Error Detection (DED) control byte. This field can have a value of 0, 1, or 2. If the value is 0, the DED function is enabled using the 16 bit checksum method. If the value is 1, the DED function is enabled using the 16 bit CRC method. If the value is 2, the DED is disabled. SW1.3 must also be enabled (ON) to enable the DED function. See section 2.7.
 - The second data field is the Communication Time out Timer (CTT) control byte. This field can have a value of 0 or 1. A value of 0 enables the CTT. A value of 1 disables the CTT. SW1.4 must also be enabled (ON) to enable the CTT function. See section 2.7.
 - The third data field controls the STI alarm message function. A value of 0 disables the alarm message function. A value of 1 enables the alarm message function.
 - The fourth data field contains the STI display scan time delay (in seconds). This value can range from 0 (1 second delay) to 9 (10 second delay). This controls the amount of delay between scans when the STI is in Stand-alone mode.
 - Data fields 5, 6, 7, and 8 are reserved for future use. These fields should always contain "0".
 - <ETX> is ASCII 03 hex
 - Optional five character checksum

TMRT = 29 mS

TDTT = 51 mS

Command 11 Hex - Read custom DDA command table

This command returns the list of DDA commands stored in the custom command table. This command table can only be used by the STI when it is in the Stand-alone mode and SW2 is set to read commands from the custom table.

Data Format -<STX>ddd:ddd:ddd:ddd:ddd:ddd:ddd:ddd<ETX>cccc
 - <STX> is ASCII 02 hex
 - Fixed length data record with eight fields each having three characters. The first field contains the command for gauge #1, the second contains the command for gauge #2, etc. Each field is separated by a colon. Each command value is the ASCII representation of the decimal equivalent DDA command (i.e. 001, 002, etc.).
 - <ETX> is ASCII 03 hex
 - Optional five character checksum

TMRT = 70 mS

TDTT = 88 mS

Command 12 Hex - Not defined

Command set 4 - 13 Hex to 17 Hex **(High level memory write commands)**

High level memory write commands consist of several components (or data communications sequences). Multiple data communication sequences are required to insure integrity of the memory data transfers. The first component of any memory write command consists of the <address><command> sequence. This will activate the respective STI module. The additional components contain the actual data elements to be written to predefined EEPROM memory locations.

Command 13 Hex - Write firmware control code

Host issued command (part 1)

- Data format
- <address><command>
 - <address> is the address (80 hex to BF hex) of the STI
 - <command> is the STI memory write command

After the address and command byte are transmitted by the host, the addressed STI module will “wake up” and echo or transmit its address and the command which it received. The STI will remain active, waiting for the second part of the memory command to be issued by the host. If the second part of the command is not received by the STI within one second (assuming the CTT is enabled), or the command is not received in the proper format, the STI will return to sleep mode.

Host issued command (part 2)

- Data Format
- <SOH>d:d:d:d:d:d<EOT>
 - <SOH> is ASCII 01 hex
 - Fixed length record containing eight data fields. Each field consists of one character. Fields are separated by colons.
 - See Command 10 Hex for individual field definitions.
 - <EOT> is ASCII 04 hex

STI module response (verification sequence):

- Data Format
- <STX>d:d:d:d:d:d<ETX>ccccc
 - <STX> is ASCII 02 hex
 - Fixed length record that should contain the same data that was transmitted by the host. The host should use this data for verification purposes.
 - <ETX> is ASCII 03 hex
 - Optional five character checksum

Host issued command (part 3)

- Data format
- <ENQ>
 - <ENQ> is ASCII 05 hex. It is sent by the host and indicates that the verification is correct and to proceed with the memory write sequence. If the CTT function is enabled, the ENQ character must be received within one second.

STI module response - successful memory write.

Data Format - <ACK>ccccc
- <ACK> is ASCII 06 hex. This character is sent by the STI module to confirm to the host that the EEPROM memory write cycle was completed successfully.
- Optional five character checksum

STI module response - unsuccessful memory write.

Data Format - <NAK>Exxx<ETX>ccccc
- <NAK> is ASCII 15 hex. This character indicates that the memory write was not successful.
- Exxx is an error code defining the memory write error that occurred during the EEPROM write cycle. "E" is ASCII 45 hex which indicates an error code follows. The xxx indicates the specific error code number from 000 to 999. See Section 3.8 for error code descriptions.
- <ETX> is ASCII 03 hex
- Optional five character checksum

EEPROM write time is 10mS per byte. The <ACK> or <NAK> response will not be transmitted by the STI module until the memory bytes have been written and verified or a memory write error has caused the STI to time out. All high level memory write commands adhere to the sequence as described above and consist of the following components:

1. Host issued command (part 1): <address><command>
2. STI module response: <address><command> echoed
3. Host issued command (part 2): data to be written to EEPROM memory including control characters.
4. STI module response: (verification sequence)
5. Host issued command (part 3): <ENQ>
6. STI module response: <ACK> or <NAK>

Descriptions for the remaining high level memory write commands will include only the data format for part 2 of each host issued command.

Command 14 Hex - Write LOW alarm limits

Alarm limits and the alarm message control function can only be used in STI Stand-alone mode.

Host issued command (part 2):

- Data Format
- <SOH>n:c:ddd.dd<EOT>
 - <SOH> is ASCII 01 hex
 - Variable length record with three data fields. The first data field is one byte long and contains the gauge number (1 to 8) where the new low alarm limit will be written to. A colon field separator follows.
 - The second field is one byte long and contains only 1, 2, or 3 which corresponds to the parameter being written (1 = LEVEL 1, 2 = LEVEL 2, and 3 = TEMPERATURE).
 - The third field contains the actual alarm limit data to be written to EPROM memory. This is a variable length field with 1 to 3 characters to the left of the decimal and 2 characters to the right of the data field. Alarm limit data can range from 0.00 to 999.99 for level and -40.00 to 300.00 for temperature alarm limits.
 - <EOT> is ASCII 04 hex

Command 15 Hex - Write HIGH alarm limits

Host issued command (part 2):

- Data Format
- <SOH>n:c:ddd.dd<EOT>
 - Format for this command same as Command 14 Hex.

Command 16 Hex - Write custom DDA command table.

This command is used to write custom DDA commands to the command table. The command table is only used in Stand-alone mode. Commands must be written as an ASCII representation of the command in decimal (rather than hex). For example, if the desired command is 0A hex, it must be converted to 10 decimal. Then the command should be converted to ASCII and a "0" must be inserted at the beginning, in order to make the field three characters long. The chart shows the DDA commands available for writing to the command table. If any DDA command not on this chart is written to the command table, a "BAD CONFIG" message will be displayed on the LCD screen.

Host issued command (part 2)

Data format:

- <SOH>n:ddd<EOT>
- <SOH> is ASCII 01 hex
- Fixed length record with two fields. The first field is fixed at one character long and contains the DDA gauge number (1 to 8) for the command to be used with.
- The second data field contains the command in an ASCII equivalent in decimal of the DDA hex command (i.e., DDA command 2B hex = "043" decimal) of the command you want to use. Only the STI compatible commands may be used. Below is a chart showing all possible commands that the STI can be programmed for use in Stand-alone mode. By default, all locations are set to DDA command 0A hex (010) when shipped from the factory.
- <EOT> is ASCII 04 hex

Data types displayed	Displayed Resolution	DDA (HEX)	Command (DECIMAL)
Level 1	0.1 inch	0A	010
Level 2	0.1 inch	0D	013
Level 1, Level 2	0.1 inch	10	016
Level 1, Level 2,	0.1 inch	2B	043
Avg. Temp			
Level 1	0.01 inch	0B	011
Level 2	0.01 inch	0E	014
Level 1, Level 2	0.01 inch	11	017
Level 1, Level 2,	0.01 inch	2C	044
Avg. Temp			
Avg. Temp	1 degree	19	025
Avg. Temp	0.2 degree	1A	026

Command 17 Hex (not defined)

**Command set 5 - 18 Hex to 1B Hex
(LCD Write Commands - Auto Format Mode)**

STI LCD write commands consist of several components similar to memory write commands. Multiple data communications sequences are required to insure integrity of the data transfers. The first component of any LCD data write command consists of the usual <address><command> data sequence necessary to activate the respective STI module. The second component consists of the actual data to be displayed on the LCD.

Command 18 Hex - Write level and temperature data to LCD

Host issued command (part 1)

Data Format - <address><command>
- address is the STI module address (80 hex to BF)
- command is STI command 18 hex

After the address and command bytes have been transmitted by the host, the respective STI module will “wake-up” and transmit (echo) its local STI address and the received command. The STI will remain active, waiting for the second part of the LCD data write command to be issued by the host. If the second part of the LCD data write command is not received in

one second, and the communications time out timer is enabled, the STI will cancel the current command and go back to sleep mode. If the second part of the command is not received in the proper format, the STI module will transmit a <NAK> character along with the proper error code back to the host.

Host issued command (part 2)

Data Format: - <SOH>ddd.dd:ddd.dd:ddd.d<EOT>ccccc
 - <SOH> is ASCII 01
 - Variable length record with three data fields. The first field is for LEVEL 1 data. It can contain 0 to 6 characters and can include a decimal point and a negative sign. If a decimal point is used, there can be a maximum of three characters to the left of the decimal point and two characters to the right of the decimal point. The "LEV1" icon is enabled only when data is provided for the level 1 field.
 - The second field is for LEVEL 2 data. It can contain 0 to 6 characters and can include a decimal point and a negative sign. If a decimal point is used, there can be a maximum of three characters to the left of the decimal point and two characters to the right of the decimal point. The "LEV 2" icon is enabled only when data is provided for the level 2 field.
 - The third field is for the TEMPERATURE data to be written to the LCD. It can contain 0 to 5 characters. It can include a decimal point and a negative sign. If a decimal point is included, the data is limited to a maximum of three characters to the left of the decimal and one character to the right of the decimal. The "TEMP" icon is enabled only when data is provided in the temperature field.
 - <EOT> is ASCII 04 hex
 - Optional five character checksum

EXAMPLE 1: <SOH>100.00:200.00:33.3<EOT>cccc

This example displays level 1 as 100.00 with the LEV1 icon on, display level 2 as 200.00 with the level 2 icon on and display temperature as 33.3 with the TEMP icon on. Optional checksum is shown. Figure 14 shows how the STI display should appear after transmitting this example to it.

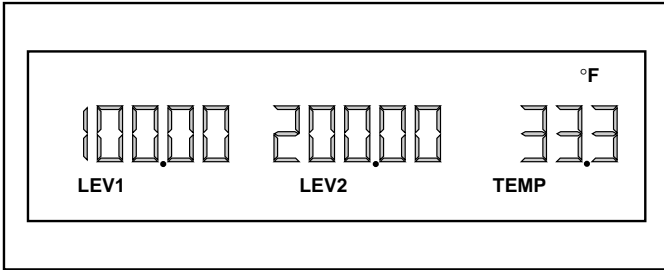

Figure 3.3 - Example 1 LCD Display (Auto Format Mode)

EXAMPLE 2: <SOH>100.00::33.3<EOT>

This example displays level 1 as 100.00 with the LEV1 icon on and display temperature as 33.3 with the TEMP icon on. The LEV2 icon would automatically be turned off. Error detection checksum is not used in this example.

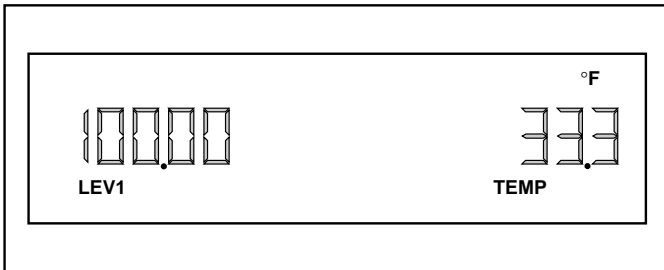

Figure 3.4 - Example 2 LCD Display (Auto Format Mode)

NOTE:

Only ASCII data characters 0 through 9, : (colon), . (decimal point), - (negative sign), <SOH> (ASCII 01 hex) and <EOT> (ASCII 04 hex) are allowed with LCD data write commands 18 and 19.

STI module response - LCD data write successful

Data Format - <ACK>ccccc
- <ACK> is ASCII 06 hex. This character is sent by the STI to confirm to the host that the LCD data write command was received in the proper format and was displayed to the LCD.
- Optional five character checksum.

TMRT = 400 mS

STI module response - LCD data write not successful

Data Format - <NAK>Exxx<ETX>ccccc
- <NAK> is ASCII 15 hex.
- Error code as defined in Section 3.8 of this manual.
- Optional five character checksum

TMRT = 50 mS

Upon completion of an LCD write command, the SCAN icon will flash briefly in order to provide visual indication to anyone viewing the LCD that new data has been displayed. All STI LCD data write commands adhere to the communication sequence as described above and consists of the following components.

1. Host issued command (part 1): <address><command>
2. STI module response: <address><command> (echo)
3. Host issued command (part 2): data to be written to LCD (including control characters).
4. STI module response: <ACK> or <NAK>

The remaining descriptions for the other LCD data write commands will include only the data format for part 2 of each host issued command.

Command 19 Hex - Write level and temperature data with LCD ICON control codes.

Host Format

- <SOH>ddd.dd:ddd.dd:ddd.d:dddd< EOT>ccccc
- <SOH> is ASCII 01 hex
- Variable length record with four data fields.
- The first three data fields contain LEVEL 1, LEVEL 2, and TEMPERATURE data. The format for these fields is the same as described for command 18 hex.
- The fourth field has a fixed length of five characters and contains the icon control data. From left to right the first three characters control the alarm HI/LO icons for LEV1, LEV2, and TEMP respectively. If the character is "0", both the HI and LO icons are off. If the character is "1", then the LO icon will be on. If the character is "2", then the HI icon will be on. The fourth character in the ICON control field controls the scan number icons. If the character is "0", then the scan number icons will be turned off. If the character is between "1" and "8", then the respective scan number icon will be on. The fifth character in this field controls the TEMP icon and also the temperature units icon. If the character is "0" the TEMP and temperature units icons (°F and °C) are all off. If the character is "1" the TEMP icon and °F icons are both on. If the character is "2" then the TEMP icon and °C icons are both on.
- <EOT> is ASCII 04 hex
- Optional five character checksum

EXAMPLE 3: <SOH>100.00:200.00:33.3:12201<EOT>ccccc

This example displays level 1 as 100.00 with the "LEV1" and "LO" icons on, level 2 displays as 200.00 with "LEV2" and "HI" icons on, and temperature as 33.3 with the "TEMP" and "HI" icons on. The scan number icons will be off.

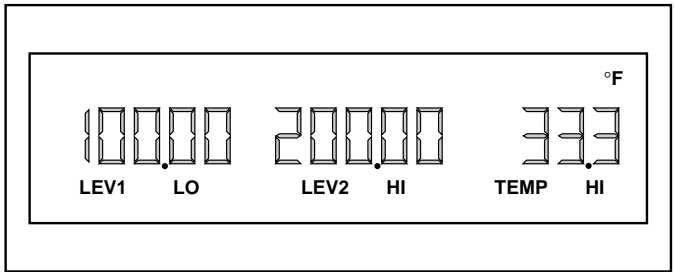

Figure 3.5 - Example 3 LCD Display (Auto Format Mode)

Commands 1A Hex and 1B Hex - Reserved

**Command set 6 - 1C Hex to 1F Hex
(LCD Write Commands - Manual Format Mode)**

Descriptions for LCD data write command in this section include only the data format for part 2 of each host issued command. See the previous command set for additional information on how to issue these LCD data write commands.

Command 1C Hex - Write 16 character display data

Host issued command (part 2)

- Data Format
- <SOH>dddddddddddddd<EOT>cccc
 - <SOH> is ASCII 01 hex
 - The data record contains one field with a fixed length of 16 characters. Pad the field with the space character (ASCII 20 hex) if necessary. The data record may contain any characters listed in Section 3.6.
 - <EOT> is ASCII 04 hex
 - Optional five character checksum

EXAMPLE 4: <SOH>1234567890123456<EOT>cccc

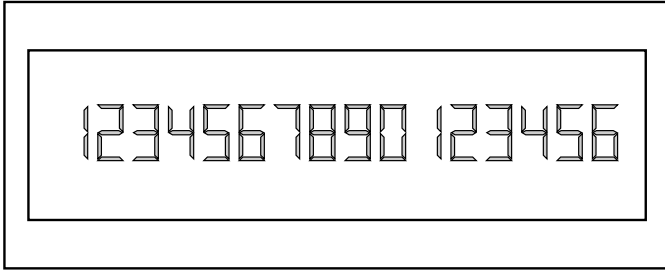

Figure 3.6 - Example 4 LCD Display (Manual Format Mode)

EXAMPLE 5: <SOH>~~~1234567890~~~<EOT>cccc

NOTE:

Blank spaces are shown as the character “~” in above example for clarity.

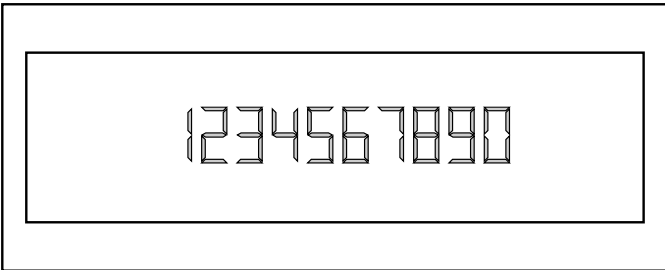

Figure 3.7 - LCD Display (Manual Format Mode)

Command 1D hex - Write 16 character data to LCD (with icon control field)

Host issued command (part 2):

Data Format -<SOH>dddddddddddddd:eeeeeee<EOT>cccccc

- <SOH> is ASCII 01 Hex
- This fixed length data record contains two fields. The first field has a fixed length of 16 characters. It should be padded with the space character (ASCII 20 hex) if necessary. The data record may contain any characters listed in Section 3.6.
- The second field contains the eight icon control characters. From left to right, the first three icon control characters control the "LEV1", "LEV2", and "TEMP" icons. If the character in any one of these fields is a "0", then the corresponding icon is off. If the character is a "1" then the corresponding icon is on. If the character in this field is a "2" then the "LO" icon is enabled in addition to the respective "LEV1", "LEV2", or "TEMP" icon. If the character is a "3" then the "HI" icon is enabled in addition to the respective "LEV1", "LEV2", and "TEMP" icons. The fourth icon control character controls the scan number icon. If "0" then all scan numbers are off. If "1" to "8" then the scan number will be "1" to "8" accordingly. The fifth control character is for the temperature unit. If "0", no temperature unit will be shown. If the character is "1" then the "F" icon will be on. If the character is "2" then the "C" icon will be on. The sixth control character controls the "ERROR"/"TEST" icons. If "0" neither icon will be on. If the character is "1" then the "ERROR" icon will be on. If the character is "2" then the "TEST" icon will be on. The seventh icon control character controls the decimal points for level 1 and level 2 data fields. If the character is "0" then neither decimal point will be on. If the character is "1", the level 1 decimal point will be on. If the character is "2" the level 2 decimal point will be on. If the character is "3" then both the level 1 and level 2 decimal points will be on. The eighth icon control character controls the temperature decimal point. If the character is "0" then neither decimal point will be on. If the character is "1" then the left decimal point will be on. If the character is "2" then the middle decimal point will be on. If the character is "3" then the right most decimal

point will be on.

- <EOT> is ASCII 04 hex.

- Optional five character checksum.

3.6 LCD Display and Optional Back Light

The STI uses a custom Liquid Crystal Display (LCD) for displaying information. The LCD consists of sixteen seven-segment characters and thirty-one special icons. The seven segment displays can display the following characters: blank, “-”, “0” to “9”, “?”, “A” to “J”, “L”, “N” to “P”, “R” to “U”, “Y” and “Z”. Although the entire alphabet can not be displayed, many useful messages can be generated with the available characters (i.e., NO ECHO, RESET, ETC.). Some characters may be displayed in lower case. If an alphanumeric character not in the above list is used in one of the display writing commands, a “blank” will be displayed in its place. Figure 19 shows the available character and icon locations.

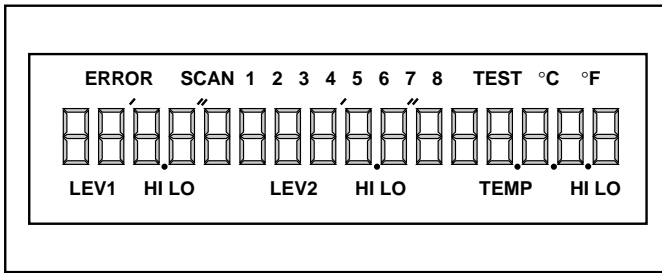

Figure 3.8 - STI Custom LCD (All segments and icons on)

The optional LCD back light uses a separate power supply. Power for the back light must be applied through a separate safety barrier if used in an intrinsically safe application. The back light can be operated by bringing a magnet within close proximity of an internal reed switch. The magnet must have sufficient strength to make the reed switch contacts engage from 3/4" away, through the cast aluminum housing. The reed switch is located on the left hand side, near the center of the enclosure.

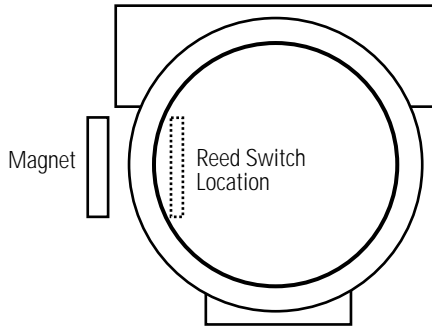

Figure 3.9 - Reed Switch Location

In non-intrinsically safe applications, the backlight can be enabled all the time by setting an internal jumper. Contact the factory for additional information about enabling the backlight continuously.

The LCD contrast is adjustable. To make contrast adjustments, the cover must first be removed. There is a small hole (marked “CONTRAST”) in the aluminum panel. Using a small screwdriver, you can adjust the contrast level. Do not use the LCD test mode to adjust the STI contrast because it is best to have some of the LCD segments or icons OFF. That way the true contrast between the ON segments and the OFF segments is more visible. Adjust the LCD contrast to a level that is readable in ambient light conditions present at the STI installation site. See Section 2.9 for display contrast adjustment.

3.7 Programming the STI

The STI is shipped from the factory with certain pre-programmed default values. You may change the pre-programmed values as needed for your application. To change values you must “program” new values. To program an STI display, you must first stop any communications from the host to the STI (if in Network Mode). If the STI is in Stand-alone mode, you will have to put the STI in Network Mode by setting the power override and mode switches. To put the STI in Network mode, configure Switches 1 & 2 as follows: SW1.1 = OFF, SW1.2 = ON. You will also have to set the address for the STI or use the address currently set with SW2. Follow the guidelines provided below in Sections 2.7 and 3.2 to program the STI various parameters.

The HT100 device (available from MTS sensors) is a hand held terminal which allows the user to program and troubleshoot both the DDA gauge and the STI display. It also simplifies the programming of an STI. You do not have to type in the address/command sequences or any control codes. Just fill in the data fields on the HT100's LCD display and press a key. Without the HT100, a PC computer and MTS 'DDASETUP' software is required to program the STI.

Remember that to program the STI you had to make sure it is in Network mode. If you want the STI to run in Stand-alone mode, remember to reset the appropriate switches (SW1 and SW2).

3.7.1 STI Control Code & Mode Switch (SW1)

The STI Control Code is a group of eight memory locations which are stored in the STI EEPROM memory. Each character in the control code controls a specific characteristic of the STI. The control code can be written to memory using the STI command 13 hex. It can be read from memory using the STI command 10 hex. Each element of the STI Control Code is listed below with detailed information on how each code works.

Control code element #1 - This code in conjunction with SW1.3 controls the Data Error Detection (or DED) function. This is the method by which an STI can detect possible communications errors. It has three possible values (shown below). If you attempt to write any other value to this location, it will be ignored.

- 0 = 16 bit checksum
- 1 = 16 bit CRC (future software versions)
- 2 = DED Disabled

The switch SW1.3 must be in the "ON" position for the DED to function. If this switch is in the "OFF" position the DED will not function no matter what value the DED control code is set to.

Control code element #2 - This code is used in conjunction with SW1.4 and controls the Communications Time-out Timer (or CTT) function. The purpose of the CTT is to shut down the STI (when operating in Network mode) if a communications sequence does not take place within a specified period of time (1.0 second). It puts the STI into sleep mode to stop data collisions and to reduce current consumption on the network. This code has two possible values listed below. If you attempt to write any other possible value to this location, it will be ignored.

- 0 = CTT Enabled
- 1 = CTT Disabled

Switch SW1.4 must be in the ON position to enable the CTT function. If switch SW1.4 is OFF then the CTT will be disabled no matter what value the CTT control code is set to.

Control code element #3 - This code controls the Alarm Message Function. The alarm message function is only used in Stand-alone mode. If enabled, the alarm message function controls the “HI” and “LO” icons associated with the LEVEL 1, LEVEL 2, and TEMPERATURE fields on the LCD display. This code has two possible values listed below. If you attempt to write any other possible value to this location it will be ignored:

- 0 = Alarm Message Function Disabled
- 1 = Alarm Message Function Enabled

When the alarm message function is enabled, the STI will compare level and temperature data with high and low set points which are programmed into memory. If a given value is equal to or less than its set point value, then the associated “LO” icon will come on. If a given value is equal to or greater than its set point, then the associated “HI” icon will come on.

Control code element #4 - This code is the Scan Delay Code. It sets the amount of time for the STI to delay from one scan to the next scan (Stand-alone mode only). Its value can range from 0 to 9 which corresponds to 1 to 10 seconds. For example, if the scan delay code is set to 6, the STI would always delay approximately 5 seconds from the end of one scan to the beginning of the next scan. The minimum scan delay is one second, the maximum scan delay is ten seconds.

Control code elements #5 to #8 - Reserved for future use. These control code locations should always be written as a "0".

3.7.2 Programming Alarm Setpoints

Alarm set points are functional only if you are operating in the STI Stand-alone mode and if the alarm message function is enabled (see previous section). The STI must, however, be in Network mode in order to adjust any of the programmed values. To put the STI in Network mode, set the power override and mode switches as follows: SW1.1 = OFF, SW1.2 = ON. You must also set the address for the STI or use the address currently set with SW2. Alarm set points are preset at the factory but can be adjusted in the field. For each of the possible eight gauges that can be accessed by the STI in Stand-alone mode, there are both low and high set points for LEVEL 1, LEVEL 2, and TEMPERATURE parameters. That makes a total of 24 low alarm set points and 24 high alarm set points. All low set points are preset to 0.00 and all high set points are preset to 100.00. To program the low alarm setpoint values, use command 14 hex. To program the high alarm setpoint values, use command 15 hex. To read back the low alarm setpoint levels, use command 0D hex. To read the high alarm setpoint levels, use command 0E hex.

3.7.3 Programming Custom Command Table

In Stand-alone mode, a custom command table which is stored in EEPROM memory can be utilized. If all three command setting switches on SW2 (SW2.4, SW2.5, and SW2.6) are in the ON position, then the custom command table will be used. This is the only way to send a different command to each DDA gauge. See Section 3.1 which has a chart of all commands available for programming into the custom command table. Commands are written as ASCII representations of the decimal value for the command. For example, the command 0A hex would be expressed as "010" (must be padded with "0" to fit the command format).

3.8 Error Codes

All communication and display error codes are preceded by a capital letter “E” (ASCII 45 hex) and are in the form Exxx where “xxx” can be any number shown below. The error codes used by the STI are different from those used by the DDA gauge. This allows them to easily be identified as STI error codes.

E301 - COMMAND FORMAT ERROR

The host transmitted data record does not meet proper format.

E302 - COMMUNICATION CHECKSUM ERROR

The host transmitted data record does not match the host transmitted checksum value.

E501 - EEPROM MEMORY WRITE VERIFICATION

The requested memory write was unsuccessful due to a read back verification error.

E502 - EEPROM MEMORY WRITE TIME OUT

The requested memory write was unsuccessful due to a write time out error.

E503 - EEPROM MEMORY WRITE BEYOND PAGE BOUNDARY

An attempt has been made to write data beyond a page boundary within the EEPROM. The memory write commands do not support memory writes through the EEPROM page boundaries. The EEPROM base address starts at 0000H and page sizes are 256 bytes each.

E901 - RAM READ/WRITE TEST FAILED

The STI external RAM (Random Access Memory) read / write test has failed.

E902 - ROM CHECKSUM TEST FAILED

The STI ROM (read only memory) checksum verification test has failed.

E903 - EEPROM READ/WRITE TEST FAILED

The STI EEPROM (electrically erasable-programmable read only memory) read write test failed.

E904 - EEPROM CHECKSUM TEST FAILED

The STI EEPROM data checksum test has failed.

E905 - LCD DRIVER IC COMMUNICATION FAILURE

The internal LCD IC is not communicating with the microprocessor

E906 - EXTERNAL I/O IC NOT COMMUNICATING WITH MICRO PROCESSOR

The external I/O IC is not communicating with the microprocessor.

E907 - NOT DEFINED

E908 - COMMUNICATIONS HARDWARE TEST FAILED

The communication driver/receiver hardware has failed. Internal loop back communication was not successful.

4.0 TROUBLESHOOTING AND MAINTENANCE

After the initial installation and validation of a DDA/STI system, no scheduled maintenance is required, except occasional cleaning of the glass front of the enclosure. However, it is accepted practice to perform periodic inspection to verify that the intrinsic safety of the system and associated equipment is maintained. There are many publications available on the subject of installing and maintaining intrinsically safe systems. These publications provide an excellent reference when structuring a plant maintenance and inspection program. Refer to Appendix A of this manual for a partial listing of publications on this subject.

The repair and troubleshooting of devices in an intrinsically safe system must be approached with caution. There are strict rules and guidelines that must be adhered to and it is the responsibility of the user or maintenance personnel to insure that the intrinsic safety of the system is maintained. Here is a list of some basic rules you should follow when working on an intrinsically safe system.

- Only trained and qualified personnel should be allowed to service I.S. (intrinsically safe) systems or equipment.
- Always use approved test equipment when making test measurements on an I.S. system.
- Always follow manufacturer's installation drawings and instructions when installing or servicing an I.S. system.
- Always make sure power has been removed from an I.S. system before making connections or disconnections.
- Always maintain up-to-date documentation for I.S. installations.
- Never make connections between different I.S. systems.
- Never remove or by-pass the safety barriers of an I.S. system.
- Never substitute any components in I.S. approved equipment.
- Never substitute any associated apparatus in an I.S. system.

Field wiring problems are likely to be the most often encountered problems associated with a DDA/STI network. The list of problems associated with field wiring can typically be grouped into two categories: prestart-up and poststart-up problems. Many prestart-up problems are often caused by:

- Wiring shorts due to improper terminated wires.
- Wiring shorts due to nicked or scraped wires.
- Wiring shorts due to crossed wires.
- Improperly connected shields and system grounds.
- Improper cable types.
- Excessive cable resistance.
- Damaged gauge electronics.
- Improper switch settings (i.e., invalid address).

Many poststart-up problems are often caused by:

- Cables damaged after installation.
- Water in cables, conduits, or junction boxes.
- Corroded connections or wire splices.
- Modifications to existing wiring.
- Marginally excessive cable resistance.
- STI or DDA gauge electronics failures.
- Electronics damaged due to high voltage transients (i.e., lightning, etc.).

CAUTION:

Always verify power is OFF before installing or removing the Micro-processor / Display "module". Use caution when handling this assembly. Use static sensitive device handling procedures. Do not allow contaminants to enter the assembly while it is removed from the housing. Place the module in a safe area until you are ready to install it.

WARNING:

When making voltage or current measurements in an intrinsically safe system, be sure to use an instrument approved for that purpose or secure any necessary "hot permits" before work begins.

4.1 Cable Isolation and Connectivity Tests

Refer to MTS DDA tank gauge manual (P/N 550164, sections 9.1 and 9.2) for additional information on cable isolation and cable connectivity tests.

4.2 Current Tests

The current test can be used to determine if a given STI display is drawing the proper amount of current when it is in stand-by and run modes. A DDA gauge or STI display that draws too much current will reduce the amount of available voltage and current to the other devices on the network. This is because the greater the current through the barrier, the greater the voltage drop across the barrier and therefore less voltage is available for other devices.

1. Make sure all power supplies are and computer devices connected to the network are OFF.
2. Remove the STI cover. Remove the electronics module. Disconnect the positive power supply lead from the STI display at terminal block P1-1.
3. Connect a current meter in series between the STI power supply terminal block (P1-1) and the positive power supply lead from the network. Temporally reinstall the electronics module, being careful to let the wires extend outside the enclosure to the voltmeter.
4. If the STI is in Stand-alone mode, you must put it in Network mode for this test. Set the power override and mode switches as follows: SW1.1 = OFF, SW1.2 = ON. Turn on the network power supply device at the control room. The computer device must be idle (the host device should not attempt communications with any network devices).
5. Measure the current draw of the STI display in stand-by mode (power override switch OFF). Record the current value below.

STI current draw (stand-by mode) = _____ mA

6. Now put the STI in power override mode. To do this, place the power override switch as follows: SW1.1 = ON.
7. Measure the current of the STI display and record the current below:

STI current draw (Power override ON) = _____ mA

8. Turn off the power supply and any computer equipment that might be on. Restore the original mode (i.e., stand-alone or network). Remove the current meter from the power supply circuit and reconnect the positive power supply conductor to the P1-1 terminal connection.

Now compare the results recorded during your testing with the values listed below in the chart. If your measured value is outside the minimum and maximum value range, that is an indication of a problem.

	<u>Minimum</u>	<u>Nominal</u>	<u>Maximum</u>
Power override ON	10.0 mA	14 mA	20.0 mA
Power Override OFF	1.0 mA	1.3 mA	1.6 mA
Back Light	25 mA	55 mA	65 mA

4.3 Using Built-in Diagnostics

There are built-in diagnostic functions in the STI that can be used to test certain features of the electronics. To perform these tests, the STI must be operational to the point that it can communicate with a host device. If you cannot communicate with the STI, use the test procedures listed in Sections 4.1 and 4.2 in order to identify cabling or STI electronic problems. The STI must be operating in Network Mode. There is a special command set assigned for this purpose. These commands are known as the diagnostic commands and they are referenced in Section 3.5 (command set 2) of this manual.

NOTE:

If you are operating the STI in Stand-Alone Mode and you want to use the built-in diagnostics, you must first configure the STI to Network mode and attach a device to use as a host terminal. The HT100 device offered by MTS is designed specifically for this function. Be sure to reconfigure the STI to Stand-alone mode (if necessary) when done.

Each diagnostic test is shown below along with a brief description of the types of problems that each test is likely to detect. Generally speaking, the failure of any of these tests indicates a failure of the electronics module. These failures are generally not repairable by the user. The electronics module is field replaceable. See Section 4.4 for instructions on how to replace the electronics module.

RAM Test (command 08 Hex) - Tests the Random Access Memory (RAM) on the STI Microprocessor board. RAM is tested by applying alternate patterns of 055 hex (0101 0101 B) and 0AA hex (1010 1010 B) to each byte of memory and then read the value written back and verify it to be correct. This checks the RAM IC as well as the address and data buses that connect the external RAM to the microprocessor. A failure of this test may indicate a short circuit on the address or data buss or a failure of the RAM IC.

ROM Test (command 09 Hex) - This test verifies that the data contained in the EPROM is correct. It does this by sequentially EX/ORing each byte in EPROM memory, along with a special parity byte. The summation of all EPROM bytes should produce a result of OFF hex. A failure of this test may indicate a defective EPROM chip or address or data buss lines shorted or open.

EEPROM Data Checksum Test (command 0A Hex) - This test not implemented.

Communications Hardware Test (command 0B Hex) - This test verifies that the communications circuit is functioning correctly by transmitting all of the characters that the STI can normally use, then verifying all characters were transmitted.

LCD Test (command 0C Hex) - This test enables all of the segments and icons on the LCD display. They stay on for three seconds then go off. This test can detect the failure of the LCD controller IC, but not the LCD segments. If you do not see all segments and icons on, but did not receive an error code, then the LCD or printed circuit board is defective. If an error code is generated by the STI then the LCD Controller I.C. is defective.

4.4 Replacing Printed Circuit Boards

If troubleshooting results reveal that the electronics have been damaged, they will need to be replaced. Replacement of the module can easily be done in the field by any qualified instrument technician.

CAUTION:

Always verify power is off before installing or removing the Microprocessor / Display "module". Use caution when handling this assembly. Use static sensitive device handling procedures. Do not allow contaminants to enter the assembly while it is removed from the housing. Place the module in a safe area until you are ready to install it.

Remove the cover from the STI enclosure, then remove the electronics module by pulling outward. Insert the new module by aligning the small and large connectors with their mating connectors on the mother board. Set the switch configuration as necessary (i.e., same as defective module).

If you had specific set point values or custom commands programmed into the STI, you will have to reprogram those identical settings into the replacement module. If the original module's EEPROM memory has been previously archived onto a floppy disk by using the HT100 (in conjunction with the DDASETUP PC program), then you may upload it to the new replacement module using the HT100. Consult the HT100 manual for more information on how to archive EEPROM data using the HT100. Otherwise, all data will need to be reentered manually using an HT100.

Refer to Sections 3.5 to 3.7 for information on how to program the STI.

4.5 Upgrading Firmware

If future firmware revisions are issued, you may want to upgrade your current firmware. This may allow you to take advantage of new features, commands, etc. The firmware is the “program” that operates the STI and it is contained on one 32 pin PLC device. First you must remove the cover and the electronics module.

WARNING:

Only qualified service personal should attempt to make any field modifications of this sort. Observe static sensitive device handling procedures.

On the back side of the electronics module you will find one socketed integrated circuit (IC) located on the microprocessor PCB. This is the IC (U13) containing the STI firmware. Remove this IC using the proper IC removal tool designed for removing a 44 pin PLC device. Place the prongs from the IC removal tool around the IC through the slots provided. Grip the tool around the IC and pull it firmly towards you. With the old IC removed, the new one can now be installed. Find the notch on one corner of the new IC and align it with the corner of the IC socket that is notched to accept it. Place the IC on the socket and push it firmly down. This firmware has now been upgraded and the STI can now be powered back up. To verify the correct firmware revision number use, the STI command 0F hex.

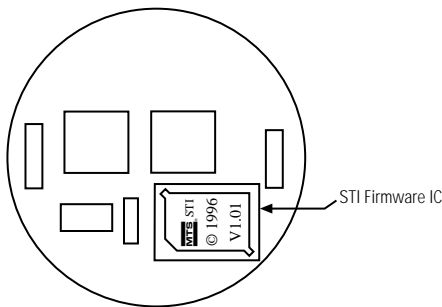

Figure 3.10 - STI Firmware IC

APPENDIX A:

Standards/Publications with information on the installation and maintenance of intrinsically safe systems.

Reference Standards:

- ANSI/ISA - RP12.6 — Installation of intrinsically safe systems for hazardous locations.
- NFPA 493 — Standard for intrinsically safe apparatus and associated apparatus for use in Class I, II and III Division 1 hazardous locations.
- NFPA 70 — National Electrical Code, Article 500, Hazardous (classified) locations.
- UL 913 — Intrinsically safe apparatus and associated apparatus for use in Class I, II, and III Division 1, hazardous locations.
- NEC - National Electrical Code, Article 504

Publications:

- E.C. Magison - INTRINSIC SAFETY, Instrument Society of America, 1984
- R.J. Redding - INTRINSIC SAFETY, McGraw-Hill, 1971
- L.C. Towle - MAINTENANCE OF ELECTRICAL INSTRUMENTATION IN HAZARDOUS AREAS, Measurement and Control, Vol 11, 1978
- R. Garside - INTRINSICALLY SAFE INSTRUMENTATION, Instrument Society of America, 1983



MTS Systems Corporation

Sensors Division
3001 Sheldon Drive
Cary, NC 27513
Telephone: 800-457-6620
Fax: 800-943-1145

**MTS Sensor Technologie GmbH
and Co. KG**

Auf dem Schüffel 9
D-58513 Lüdenscheid
Federal Republic of Germany
Telephone: 011-49-2351-95870
Fax: 011-49-2351-56491

**MTS Sensors Technology
Corporation**

Lions Plaza 805
1-1-8 Shin-Yokohama
Kohoku-ku, Yokohama 222
Japan
Telephone: 011-81-45-475-2401
Fax: 011-81-45-475-0641



Level Plus is a registered trademark of MTS Systems Corporation.
7/96 550436 Revision A DAP © MTS Systems Corporation, 1996